



TOYO LED ELECTRONICS LIMITED

Unit 10-11, 19/F, Metro Loft, 38 KwaiHei Street, Kwai Chung, N.T., Hong Kong.

Tel : (852) 2540 7288

Fax : (852) 2517 1797

http://www.toyo-led.com

E-mail : sales@toyo-led.com



P/N:TY-Y1206UR1-LS-R(1.75)

1206 package 3.2x1.6mm SMD LEDs with lens Series

SPECIFICATION FOR CUSTOMER APPROVAL

P/N:TY-Y1206UR1-LS-R(1.75)

DATE : March 19, 2018

PREPARED BY : Chen Kai

CONFIRMED BY :



PLEASE CONFIRM & SIGN BACK THIS SHEET TO US

CUSTOMER: _____

APPROVAL BY: _____

(COMPANY CHOP)

(SIGNATURE)



TOYO LED ELECTRONICS LIMITED

Unit 10-11, 19/F, Metro Loft, 38 KwaiHei Street, Kwai Chung, N.T., Hong Kong.

Tel : (852) 2540 7288

http://www.toyo-led.com

Fax : (852) 2517 1797

E-mail : sales@toyo-led.com



P/N:TY-Y1206UR1-LS-R(1.75)

1206 package 3.2x1.6mm SMD LEDs with lens Series

✧ Features:

- 3.2*1.6*1.75mm
- Mono-color type
- Soldering methods :All SMT assembly methods
- Comply ROHS standard

✧ Description

The Red source color devices are made with **InGaAlP** on sapphire Light Emitting Diode.

✧ Application

- Optical indicator
- Indicator and backlighting in telephone and fax
- Flat backlight for LCD,switch and symbol
- Light pipe application
- General use

✧ Package Dimensions

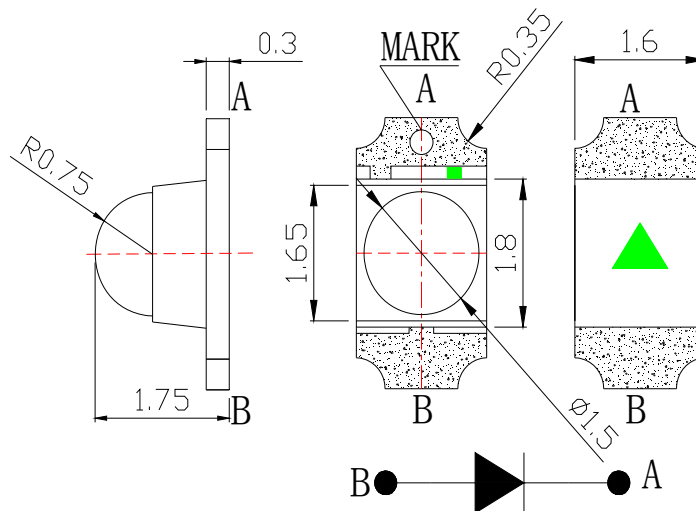

NOTES:

1. All dimensions are in millimeter[unit];
2. Tolerance is $\pm 0.1\text{mm}$ ($0.004''$) unless other specified;
3. Specifications are subject to change without notice.



TOYO LED ELECTRONICS LIMITED

Unit 10-11, 19/F, Metro Loft, 38 KwaiHei Street, Kwai Chung, N.T., Hong Kong.

Tel : (852) 2540 7288

http://www.toyo-led.com

Fax : (852) 2517 1797

E-mail : sales@toyo-led.com



P/N:TY-Y1206UR1-LS-R(1.75)

1206 package 3.2x1.6mm SMD LEDs with lens Series

Part No.	Emitted Color	Len's Color	Chip Material
TY-Y1206UR1-LS-R(1.75)	Red	Water clear	InGaAlP

✧ Absolute Maximum Ratings(Ta=25°C)

Item	Symbol	Maximum	Unit
Power Dissipation	PD	75	mW
Continuous Forward Current	I _{Fmax}	30	mA
Peak Forward Current(1/10 Duty Cycle 0.1ms Pulse Width)	I _{FP}	80	mA
Reverse Voltage	V _R	5	V
Operating Temperature Range	T _{opr}	-40 to+85	°C
Storage Temperature Range	T _{stg}	-40 to+85	°C
Lead Solder Temperature	Tsol	260°C for 3 seconds	

✧ Electrical/Optical Characteristics(Ta=25°C)

Item	Symbol	Condition	Min.	Typ.	Max	Unit
Forward Voltage	V _F	I _F =20mA	---	1.9	2.2	V
Luminous Intensity	I _V	I _F =20mA	500	1100	---	mcd
Wavelength	λ	I _F =20mA	---	617	625	nm
Viewing Angle	2θ _{1/2}	I _F =20mA	---	35	---	Deg
Reverse Current	I _R	V _R =5V	---	---	10	uA



TOYO LED ELECTRONICS LIMITED

Unit 10-11, 19/F, Metro Loft, 38 KwaiHei Street, Kwai Chung, N.T., Hong Kong.
 Tel : (852) 2540 7288 Fax : (852) 2517 1797
 http://www.toyo-led.com E-mail : sales@toyo-led.com



P/N:TY-Y1206UR1-LS-R(1.75)

1206 package 3.2x1.6mm SMD LEDs with lens Series

✧ Typical Electro-Optical Characteristics Curves

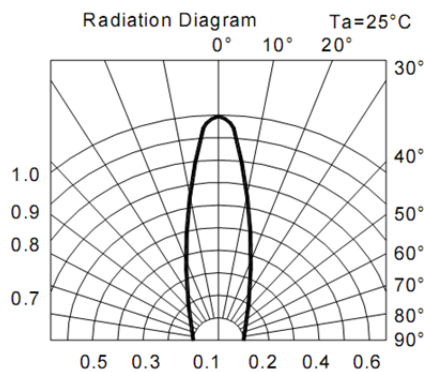
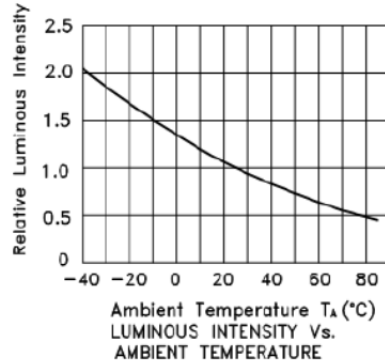
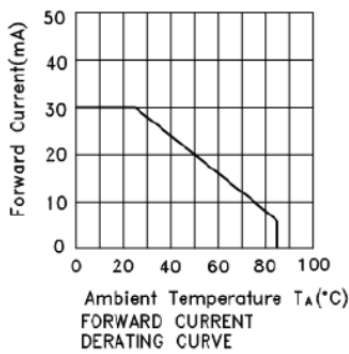
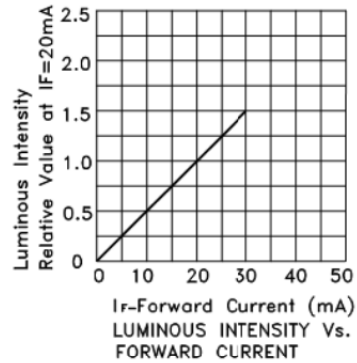
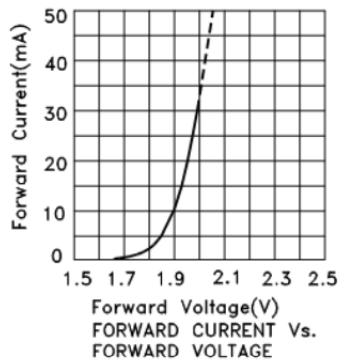
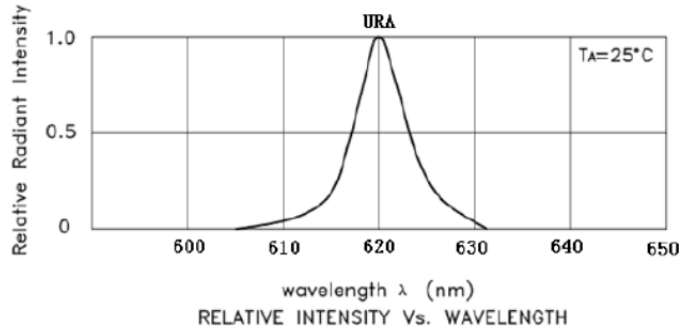



TOYO LED ELECTRONICS LIMITED

Unit 10-11, 19/F, Metro Loft, 38 KwaiHei Street, Kwai Chung, N.T., Hong Kong.

Tel : (852) 2540 7288
<http://www.toyo-led.com>

Fax : (852) 2517 1797
 E-mail : sales@toyo-led.com



P/N:TY-Y1206UR1-LS-R(1.75)

1206 package 3.2x1.6mm SMD LEDs with lens Series

◇ Reliability Test Items And Conditions

NO.	Item	Test Condition	Test Hr/cycle/time	Sample Q'ty	Ac/Re
1	Reflow	TEMP:260±5°C; Min.5Sec	6 min	22pcs	0/1
2	Temperature Cycle	H:+90°C30mins To(5mins) L:-30°C30mins	100 cycles	22pcs	0/1
3	Thermal Shock	H:+100°C20mins To(5mins) L:-40°C20mins	500 cycles	22pcs	0/1
4	High Temperature Storage	TEMP:+100°C	1000hrs	22pcs	0/1
5	Low Temperature Storage	TEMP:-30°C	1000hrs	22pcs	0/1
6	DC Operating Life	IF=20MA	1000hrs	22pcs	0/1
7	High Temperature	65°C	240hrs	22pcs	0/1
8	High Humidity	R.H.= 85%		22pcs	0/1

◇ SMT Reflow Soldering Instructions

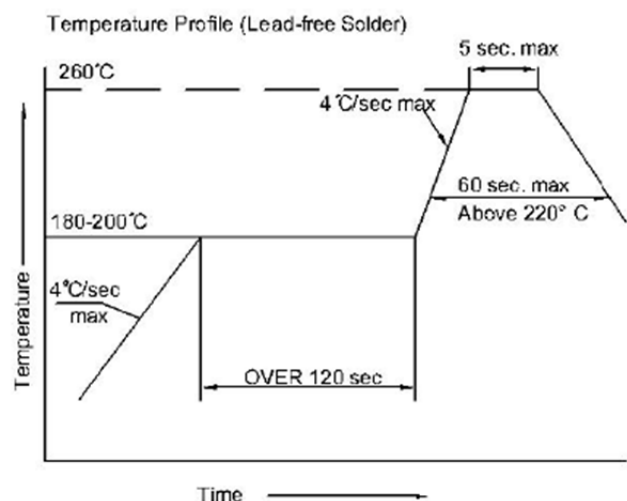
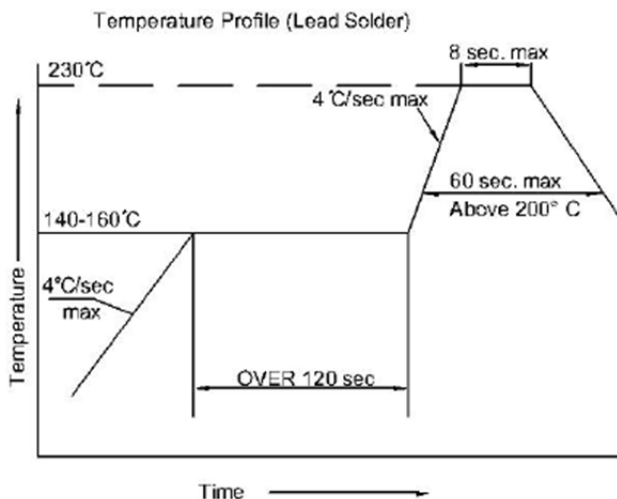



TOYO LED ELECTRONICS LIMITED

Unit 10-11, 19/F, Metro Loft, 38 KwaiHei Street, Kwai Chung, N.T., Hong Kong.

Tel : (852) 2540 7288
http://www.toyo-led.com

Fax : (852) 2517 1797
E-mail : sales@toyo-led.com



P/N:TY-Y1206UR1-LS-R(1.75)

1206 package 3.2x1.6mm SMD LEDs with lens Series

❖ Recommended Soldering Pad Dimensions

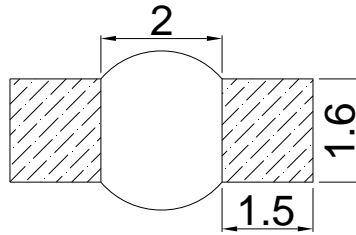

❖ Tape Specification:2000pcs

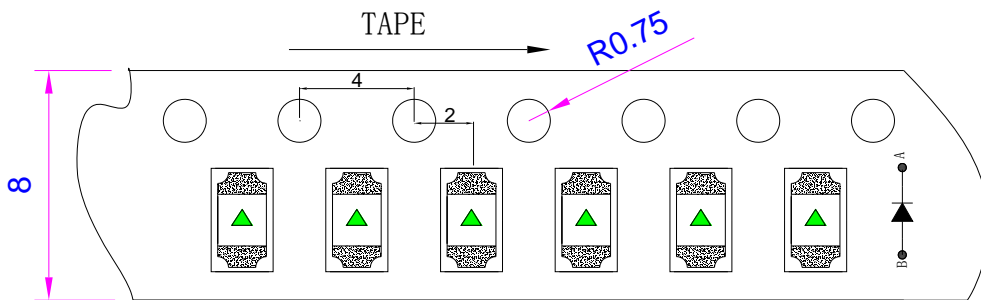
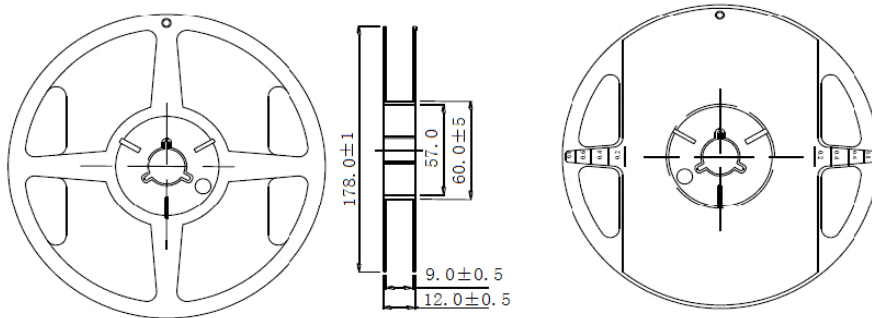

❖ Package Label

SMD LED	
PART NO: _____	QA Pass
LOT NO : _____	
Q' TY : _____	Pb
VF : _____ IV : _____	
TC : _____ BIN: _____	
DATE : _____	
TOYO LED ELECTRONICS LIMITED	
Website: http://www.toyo-led.com E-mail: sales@toyo-led.com	



TOYO LED ELECTRONICS LIMITED

Unit 10-11, 19/F, Metro Loft, 38 KwaiHei Street, Kwai Chung, N.T., Hong Kong.

Tel : (852) 2540 7288
http://www.toyo-led.com

Fax : (852) 2517 1797
E-mail : sales@toyo-led.com



P/N:TY-Y1206UR1-LS-R(1.75)

1206 package 3.2x1.6mm SMD LEDs with lens Series

❖ Package & Shipping Instructions

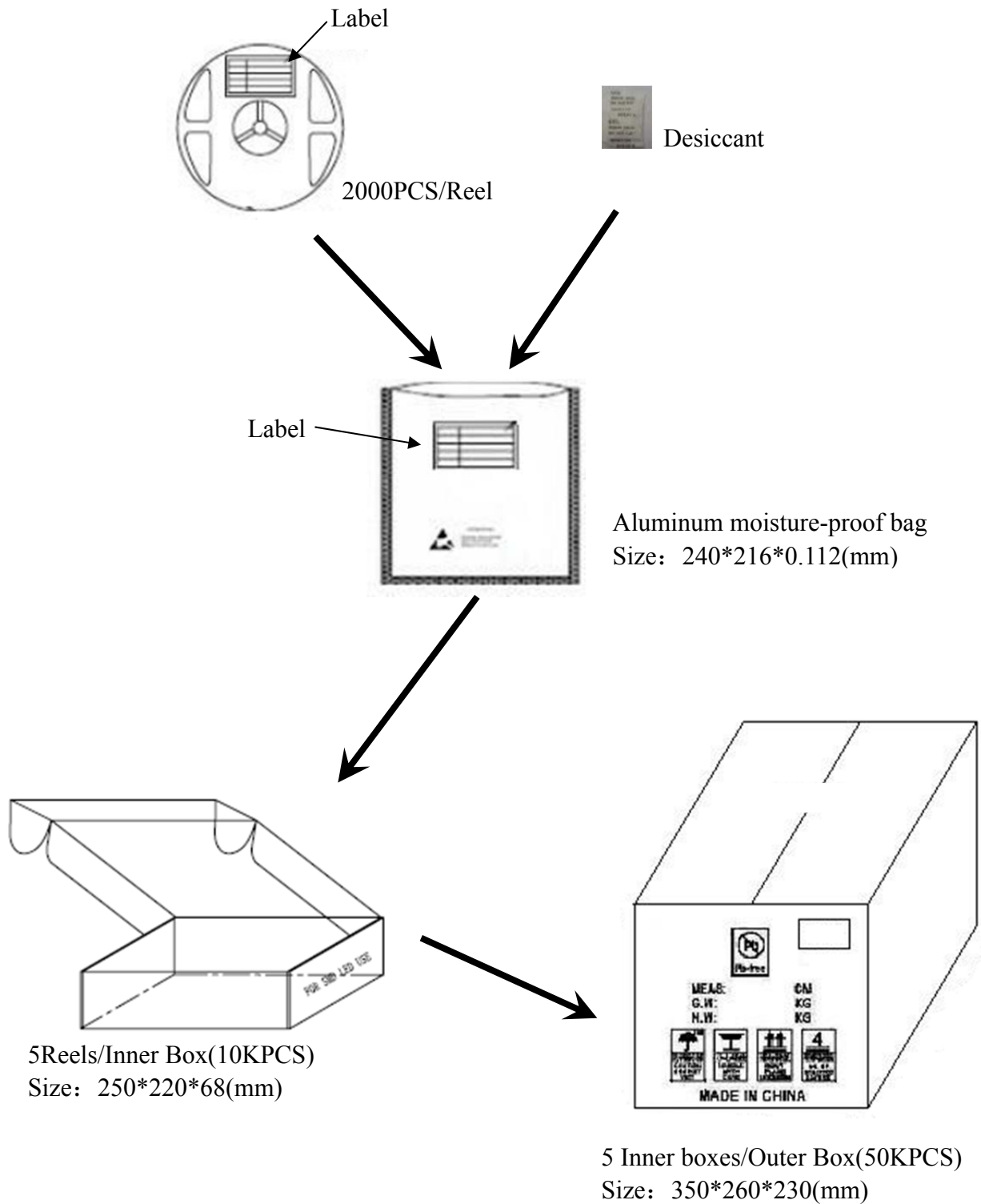



TOYO LED ELECTRONICS LIMITED

Unit 10-11, 19/F, Metro Loft, 38 KwaiHei Street, Kwai Chung, N.T., Hong Kong.

Tel : (852) 2540 7288
http://www.toyo-led.com

Fax : (852) 2517 1797
E-mail : sales@toyo-led.com



P/N:TY-Y1206UR1-LS-R(1.75)

1206 package 3.2x1.6mm SMD LEDs with lens Series

REVISION HISTORY

DATE	REVISION CONTENTS	VERSION
2018-03-14	New	A