

## Cree® J Series™ 2835 LEDs



### PRODUCT DESCRIPTION

J Series™ LEDs extend Cree’s industry-leading portfolio of lighting-class LEDs to a broader set of applications. The J Series 2835 LEDs combine high efficacy and excellent value in a reliable PCT package. The J Series 2835 LEDs are optimized for low-density lighting applications where high efficacy and smooth appearance are critical, such as downlights, troffers, and panel lights.

### FEATURES

- Industry-compatible size : 2.8 x 3.5 x 0.7 mm
- 3-V and 6-V configurations
- Flux binned at 25 °C, chromaticity binned at 85 °C
- 6500 K–2700 K ANSI CCTs available
- 70, 80 & 90 CRI available for all CCTs
- RoHS and REACH compliant
- UL® recognized component (E495478)

### PRODUCT SUMMARY

Product	Power Class	Test Temperature	Test Current	Typical Forward Voltage	4000 K, 70 CRI		3000 K, 80 CRI		Maximum Current
					Typical Flux	Typical Efficacy	Typical Flux	Typical Efficacy	
JE2835 3-V	0.5 W	25 °C	150 mA	3 V	79 lm	176 LPW	70 lm	156 LPW	240 mA
JK2835 6-V	1 W	25 °C	150 mA	6.2 V	153 lm	165 LPW	134 lm	144 LPW	200 mA



J Series™ Products are sold exclusively by Cree Venture LED Company Limited (“Cree Venture”), regardless of geography. Any orders for J Series Products that are submitted to Cree, Inc. or any of its other subsidiaries will be directed to Cree Venture for acknowledgement and order fulfillment.

**TABLE OF CONTENTS**

Order Code & Bin Code Formats ..... 3

Characteristics - JE2835 3-V ..... 4

Operating Limits - JE2835 3-V ..... 4

Flux Characteristics, Order Codes and Bins - JE2835 3-V ..... 5

Relative Luminous Flux vs. Current - JE2835 3-V ..... 6

Electrical Characteristics - JE2835 3-V ..... 6

Relative Chromaticity vs. Current - JE2835 3-V ..... 7

Relative Chromaticity vs. Temperature - JE2835 3-V ..... 7

Characteristics - JK2835 6-V ..... 8

Operating Limits - JK2835 6-V ..... 8

Flux Characteristics, Order Codes and Bins - JK2835 6-V ..... 9

Relative Luminous Flux vs. Current - JK2835 6-V ..... 10

Electrical Characteristics - JK2835 6-V ..... 10

Relative Chromaticity vs. Current - JK2835 6-V ..... 11

Relative Chromaticity vs. Temperature - JK2835 6-V ..... 11

Relative Spectral Power Distribution ..... 12

Relative Luminous Flux vs. Junction Temperature ..... 12

Typical Spatial Distribution ..... 13

Performance Groups - Luminous Flux ..... 13

Performance Groups - Forward Voltage ..... 14

Performance Groups - Chromaticity ..... 15

Reflow Soldering Characteristics ..... 23

Notes ..... 24

Mechanical Dimensions ..... 26

Tape & Reel ..... 27

Packaging ..... 28

**ORDER CODE & BIN CODE FORMATS**

Order codes and bin codes for J Series 2835 LEDs are configured in the following manner:

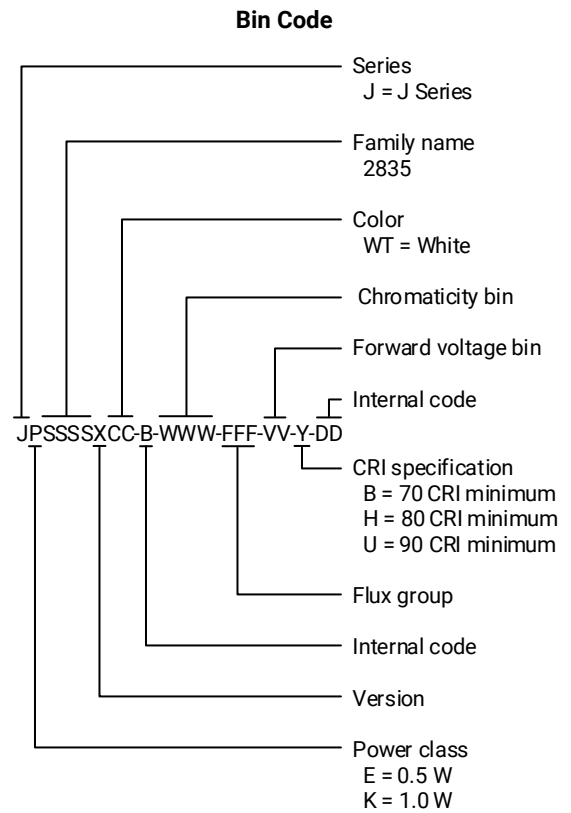
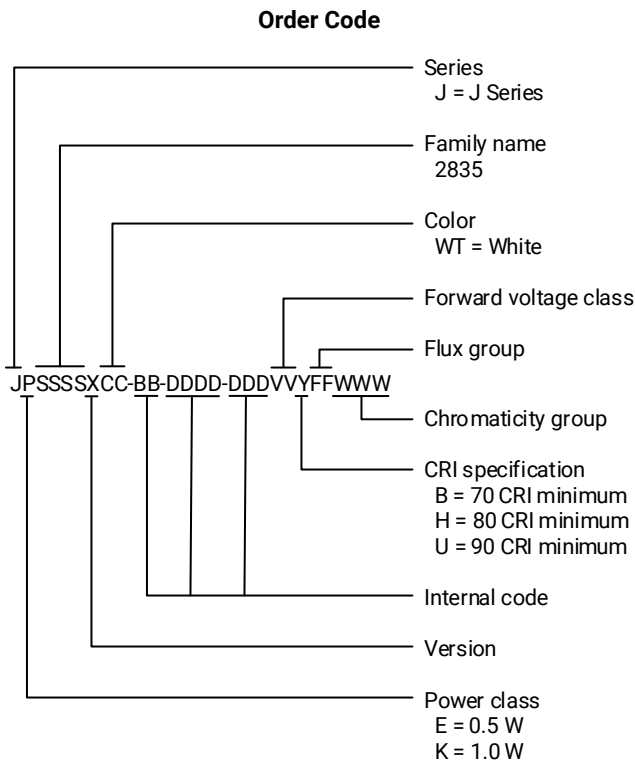

**CHARACTERISTICS - JE2835 3-V**

Characteristics	Unit	Minimum	Typical	Maximum
Thermal resistance, junction to solder point	°C/W		20	
Viewing angle (FWHM)	degrees		120	
Temperature coefficient of voltage	mV/°C		-0.9	
ESD withstand voltage (JEDEC JS-001-2012)	V		Class 2	
DC forward current	mA			240
Reverse voltage	V			5
Forward voltage (@ 15 0mA, 25 °C)	V		3.0	3.3
LED junction temperature	°C			125
Operating temperature	°C	-40		105

**OPERATING LIMITS - JE2835 3-V**

The maximum forward current is determined by the thermal resistance between the LED junction and ambient.

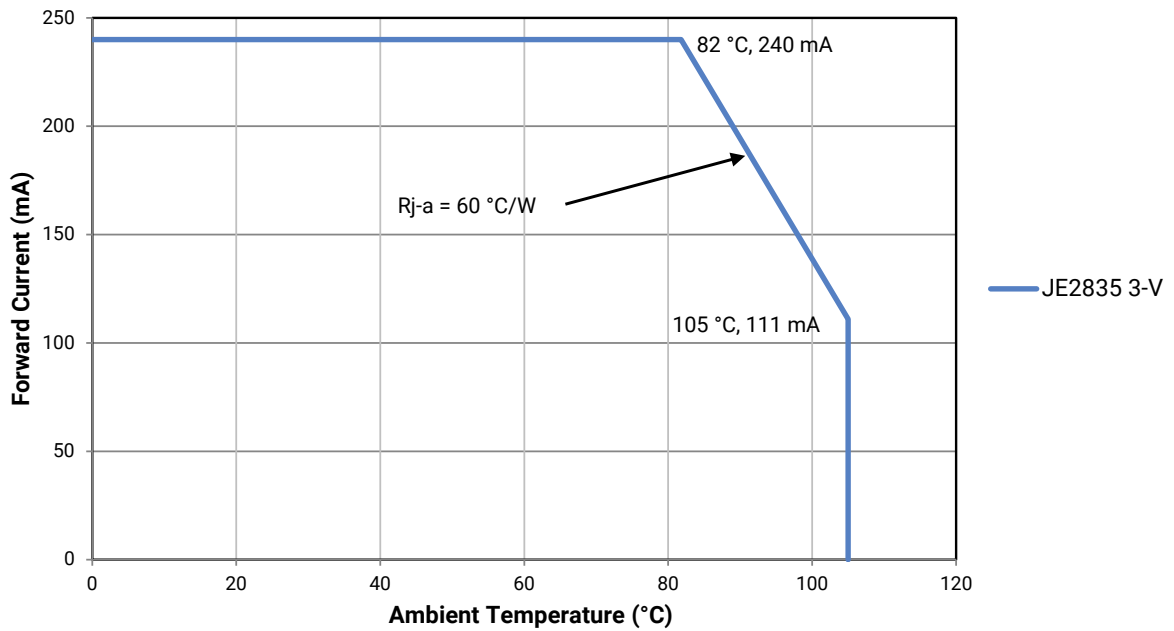

**FLUX CHARACTERISTICS, ORDER CODES AND BINS - JE2835 3-V ( $I_F = 150 \text{ mA}$ ,  $T_a = 25 \text{ °C}$ )**

The following table provides order codes for J Series 2835 LEDs. For a complete description of the order code nomenclature, please see the Order Code and Bin Code Formats section (page 3). For definitions of the chromaticity kits, please see the Performance Groups - Chromaticity section (page 15).

Nominal CCT	Minimum CRI	Flux Group	Minimum Flux (lm) @ 25 °C	Typical Flux (lm) @ 25 °C	Typical Flux (lm) @ 85 °C*	Order Code
6500 K	70	H6	72	80	71	JE2835AWT-00-0000-000A0BH665E
	80	G9	69	75	67	JE2835AWT-00-0000-000A0HG965E
	90	F9	57	64	56	JE2835AWT-00-0000-000A0UF965E
5700 K	70	H6	72	79	70	JE2835AWT-00-0000-000A0BH657E
	80	G9	69	75	67	JE2835AWT-00-0000-000A0HG957E
	90	F9	57	64	56	JE2835AWT-00-0000-000A0UF957E
5000 K	70	H6	72	79	70	JE2835AWT-00-0000-000A0BH650E
	80	G9	69	75	67	JE2835AWT-00-0000-000A0HG950E
	90	F9	57	64	56	JE2835AWT-00-0000-000A0UF950E
4500 K	70	H6	72	79	70	JE2835AWT-00-0000-000A0BH645E
	80	G9	69	75	67	JE2835AWT-00-0000-000A0HG945E
	90	F9	57	64	56	JE2835AWT-00-0000-000A0UF945E
4000 K	70	H6	72	79	70	JE2835AWT-00-0000-000A0BH640E
	80	G9	69	75	67	JE2835AWT-00-0000-000A0HG940E
	90	F9	57	64	56	JE2835AWT-00-0000-000A0UF940E
3500 K	70	G9	69	76	68	JE2835AWT-00-0000-000A0BG935E
	80	G8	66	72	64	JE2835AWT-00-0000-000A0HG835E
	90	F8	54	61	54	JE2835AWT-00-0000-000A0UF835E
3000 K	70	G9	69	74	66	JE2835AWT-00-0000-000A0BG930E
	80	G8	66	70	62	JE2835AWT-00-0000-000A0HG830E
	90	F8	54	59	53	JE2835AWT-00-0000-000A0UF830E
2700 K	70	G8	66	72	64	JE2835AWT-00-0000-000A0BG827E
	80	G7	63	69	61	JE2835AWT-00-0000-000A0HG727E
	90	F8	54	58	52	JE2835AWT-00-0000-000A0UF827E

**Notes:**

- Cree Venture maintains a tolerance of  $\pm 7\%$  on flux and power measurements,  $\pm 0.005$  on chromaticity (CCx, CCy) measurements and  $\pm 2$  on CRI measurements. See the Measurements section (page 24).
- Cree Venture J Series 2835 LED order codes specify only a minimum flux bin and not a maximum. Cree Venture may ship reels in flux bins higher than the minimum specified by the order code without advance notice. Shipments will always adhere to the chromaticity restrictions specified by the order code.
- \* Flux values @ 85 °C are calculated and for reference only.

**RELATIVE LUMINOUS FLUX VS. CURRENT - JE2835 3-V**

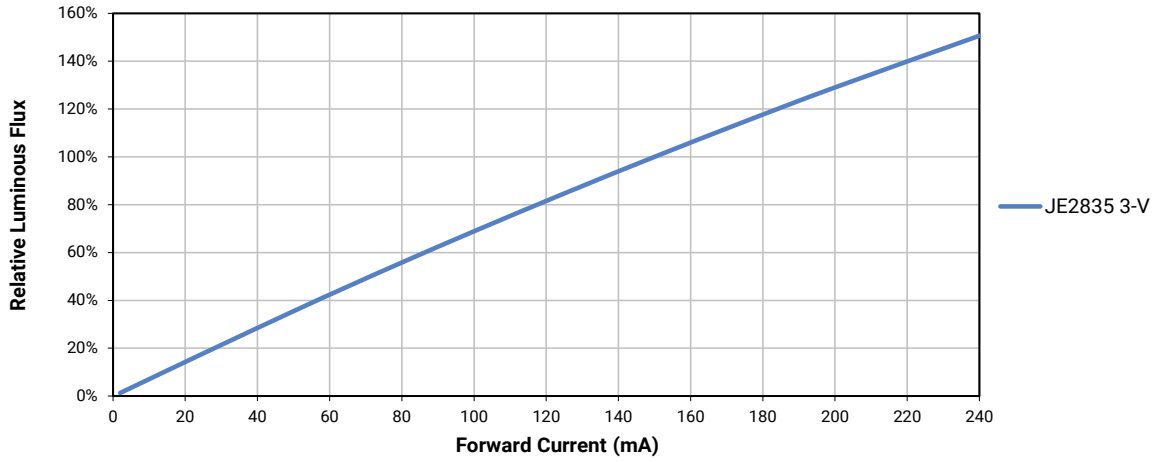

**ELECTRICAL CHARACTERISTICS - JE2835 3-V**

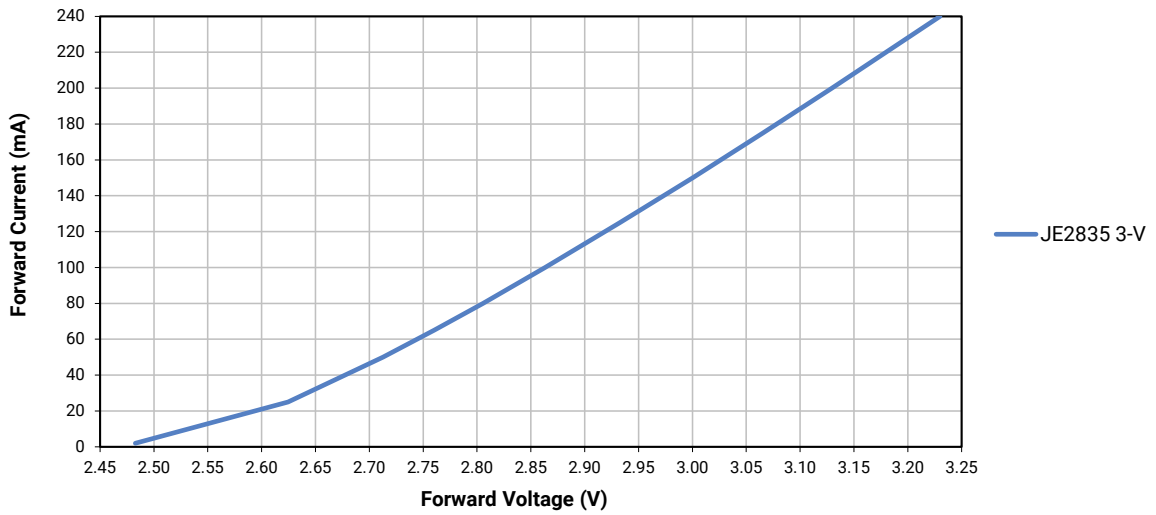

**RELATIVE CHROMATICITY VS. CURRENT - JE2835 3-V**

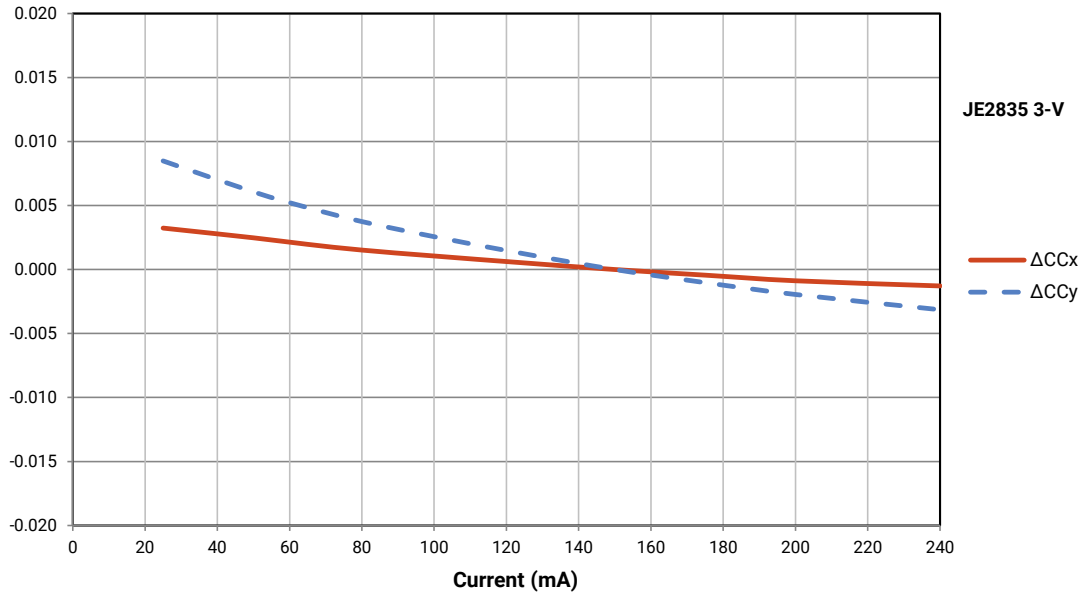

**RELATIVE CHROMATICITY VS. TEMPERATURE - JE2835 3-V**

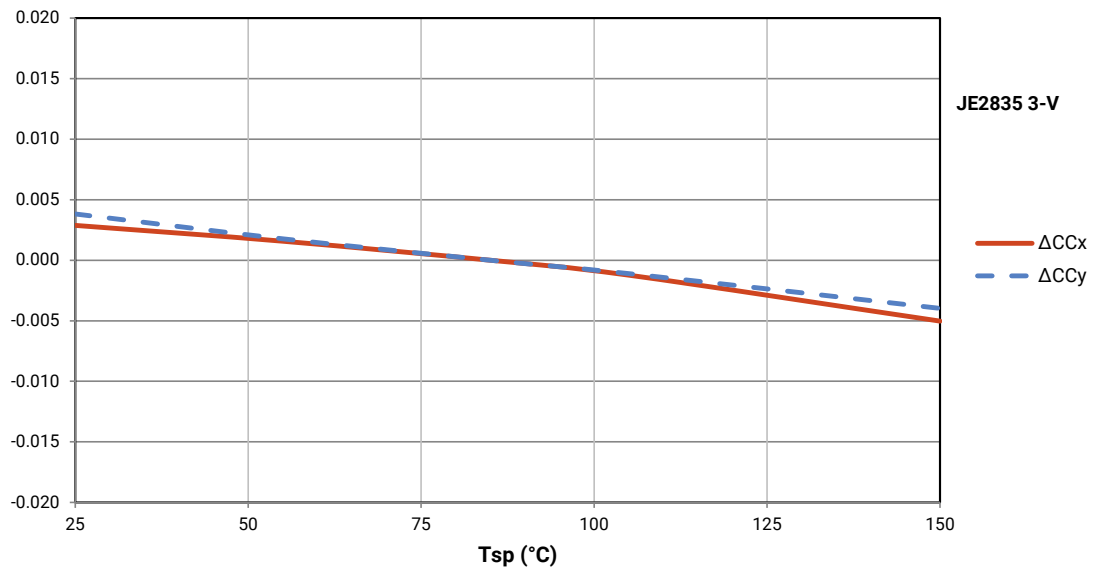

**CHARACTERISTICS - JK2835 6-V**

Characteristics	Unit	Minimum	Typical	Maximum
Thermal resistance, junction to solder point	°C/W		12	
Viewing angle (FWHM)	degrees		120	
Temperature coefficient of voltage	mV/°C		-1.7	
ESD withstand voltage (JEDEC JS-001-2012)	V		Class 2	
DC forward current	mA			200
Reverse voltage	V			5
Forward voltage (@ 150 mA, 25 °C)	V		6.2	6.6
LED junction temperature	°C			125
Operating temperature	°C	-40		105

**OPERATING LIMITS - JK2835 6-V**

The maximum forward current is determined by the thermal resistance between the LED junction and ambient.

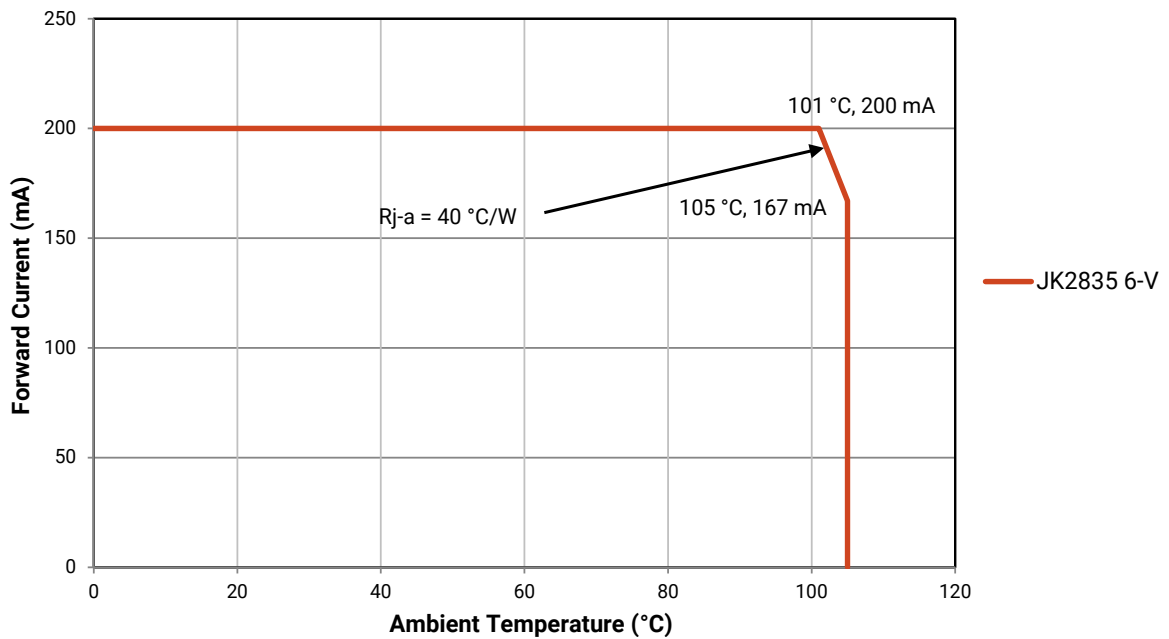



**FLUX CHARACTERISTICS, ORDER CODES AND BINS - JK2835 6-V ( $I_F = 150 \text{ mA}$ ,  $T_a = 25 \text{ °C}$ )**

The following table provides order codes for J Series 2835 LEDs. For a complete description of the order code nomenclature, please see the Order Code and Bin Code Formats section (page 3). For definitions of the chromaticity kits, please see the Performance Groups - Chromaticity section (page 15).

Nominal CCT	Minimum CRI	Flux Group	Minimum Flux (lm) @ 25 °C	Typical Flux (lm) @ 25 °C	Typical Flux (lm) @ 85 °C*	Order Code
6500 K	70	N2	140	153	135	JK2835AWT-00-0000-000B0BN265E
	80	M2	130	144	127	JK2835AWT-00-0000-000B0HM265E
	90	K2	110	122	108	JK2835AWT-00-0000-000B0UK265E
5700 K	70	N2	140	153	135	JK2835AWT-00-0000-000B0BN257E
	80	M2	130	144	127	JK2835AWT-00-0000-000B0HM257E
	90	K2	110	122	108	JK2835AWT-00-0000-000B0UK257E
5000 K	70	N2	140	153	135	JK2835AWT-00-0000-000B0BN250E
	80	M2	130	144	127	JK2835AWT-00-0000-000B0HM250E
	90	K2	110	122	108	JK2835AWT-00-0000-000B0UK250E
4500 K	70	N2	140	153	135	JK2835AWT-00-0000-000B0BN245E
	80	M2	130	144	127	JK2835AWT-00-0000-000B0HM245E
	90	K2	110	122	108	JK2835AWT-00-0000-000B0UK245E
4000 K	70	N2	140	153	135	JK2835AWT-00-0000-000B0BN240E
	80	M2	130	144	127	JK2835AWT-00-0000-000B0HM240E
	90	K2	110	122	108	JK2835AWT-00-0000-000B0UK240E
3500 K	70	M4	135	146	129	JK2835AWT-00-0000-000B0BM435E
	80	L4	125	137	122	JK2835AWT-00-0000-000B0HL435E
	90	J4	105	116	103	JK2835AWT-00-0000-000B0UJ435E
3000 K	70	M4	135	142	126	JK2835AWT-00-0000-000B0BM430E
	80	L4	125	134	118	JK2835AWT-00-0000-000B0HL430E
	90	J4	105	113	100	JK2835AWT-00-0000-000B0UJ430E
2700 K	70	M2	130	140	124	JK2835AWT-00-0000-000B0BM227E
	80	L2	120	131	116	JK2835AWT-00-0000-000B0HL227E
	90	J4	105	111	98	JK2835AWT-00-0000-000B0UJ427E

**Notes:**

- Cree Venture maintains a tolerance of  $\pm 7\%$  on flux and power measurements,  $\pm 0.005$  on chromaticity (CCx, CCy) measurements and  $\pm 2$  on CRI measurements. See the Measurements section (page 24).
- Cree Venture J Series 2835 LED order codes specify only a minimum flux bin and not a maximum. Cree Venture may ship reels in flux bins higher than the minimum specified by the order code without advance notice. Shipments will always adhere to the chromaticity restrictions specified by the order code.
- \* Flux values @ 85 °C are calculated and for reference only.

**RELATIVE LUMINOUS FLUX VS. CURRENT - JK2835 6-V**

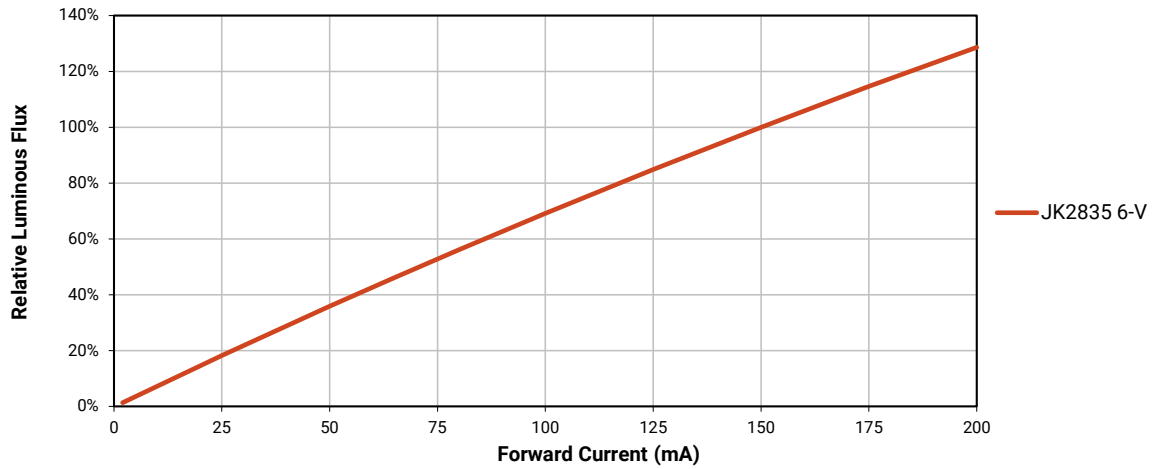

**ELECTRICAL CHARACTERISTICS - JK2835 6-V**

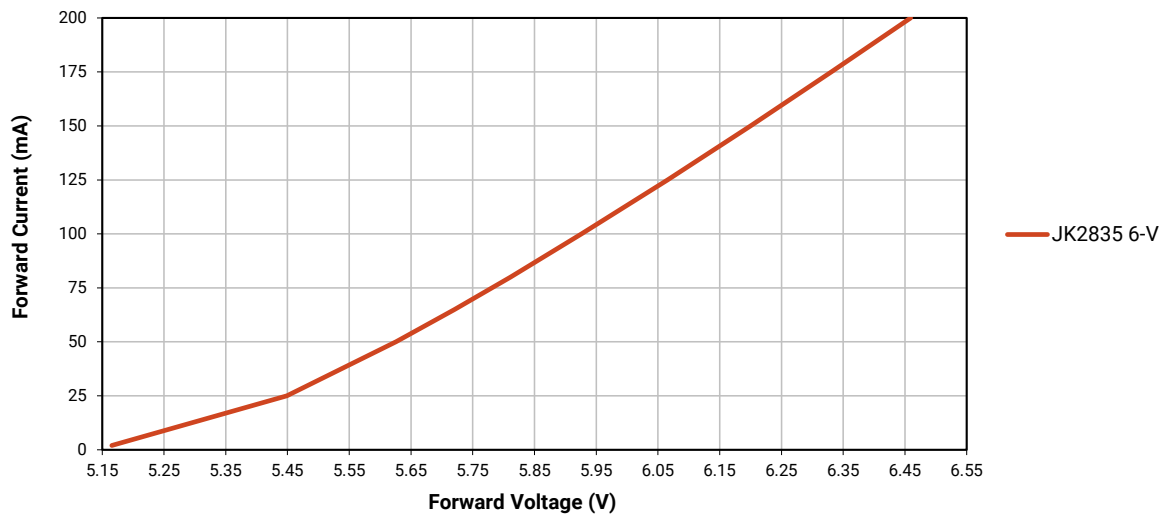

**RELATIVE CHROMATICITY VS. CURRENT - JK2835 6-V**

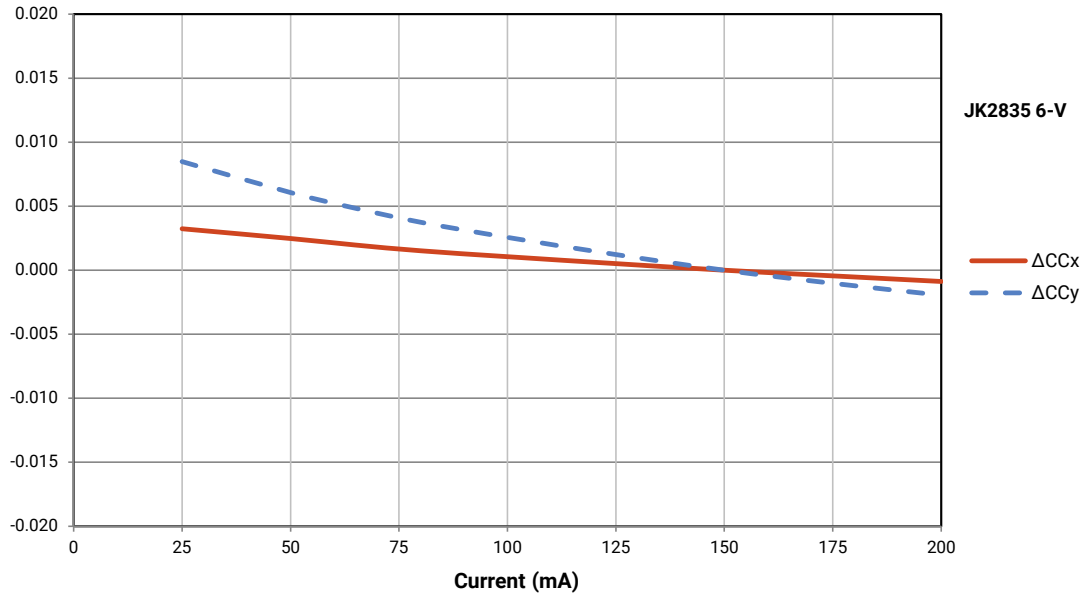

**RELATIVE CHROMATICITY VS. TEMPERATURE - JK2835 6-V**

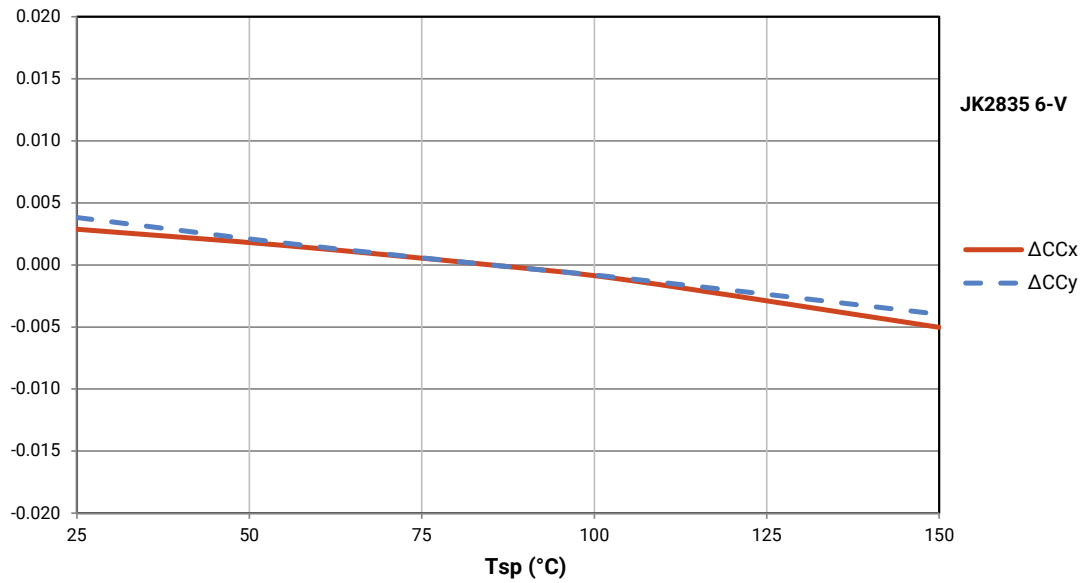

**RELATIVE SPECTRAL POWER DISTRIBUTION**

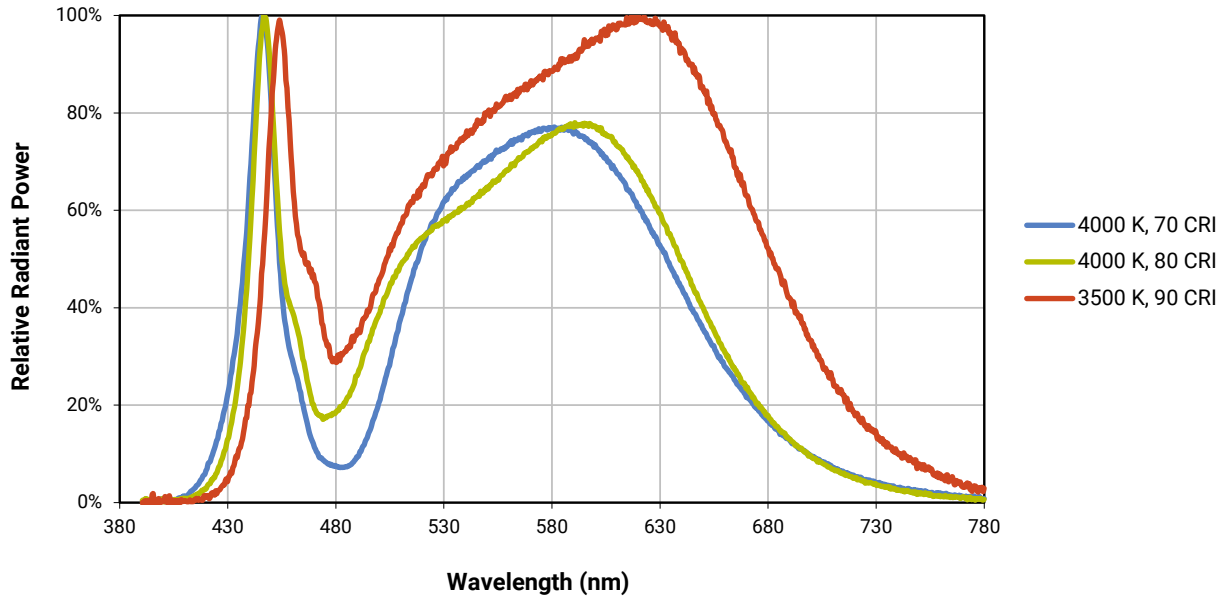

**RELATIVE LUMINOUS FLUX VS. JUNCTION TEMPERATURE**

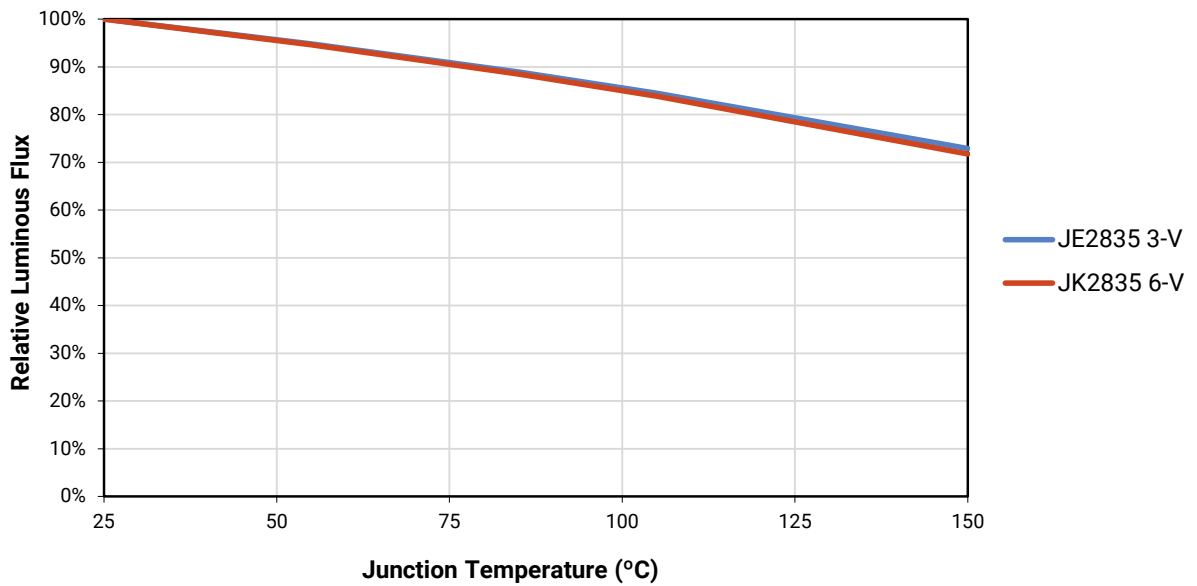

**TYPICAL SPATIAL DISTRIBUTION**

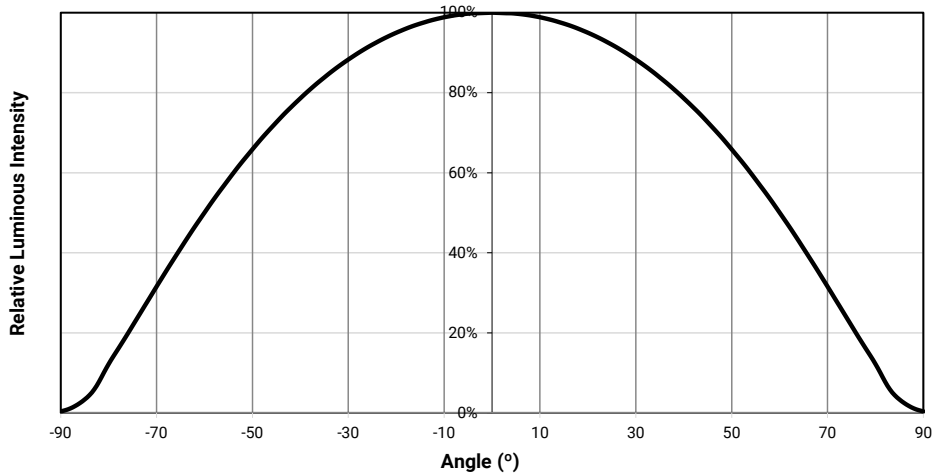

**PERFORMANCE GROUPS - LUMINOUS FLUX (T<sub>j</sub> = 25 °C)**

J Series JE2835 3-V LEDs are tested for luminous flux at 150 mA and placed into one of the following luminous-flux groups.

Group Code	Minimum Luminous Flux (lm)	Maximum Luminous Flux (lm)
F7	51	54
F8	54	57
F9	57	60
G6	60	63
G7	63	66
G8	66	69
G9	69	72
H6	72	75
H7	75	78
H8	78	81
H9	81	84
K6	84	87
K7	87	90

**PERFORMANCE GROUPS - LUMINOUS FLUX ( $T_j = 25\text{ }^\circ\text{C}$ ) - CONTINUED**

J Series JK2835 6-V LEDs are tested for luminous flux at 150 mA and placed into one of the following luminous-flux groups.

Group Code	Minimum Luminous Flux (lm)	Maximum Luminous Flux (lm)
J2	100	105
J4	105	110
K2	110	115
K4	115	120
L2	120	125
L4	125	130
M2	130	135
M4	135	140
N2	140	145
N4	145	150
P2	150	155
P4	155	160
Q2	160	165
Q4	165	170

**PERFORMANCE GROUPS - FORWARD VOLTAGE ( $T_a = 25\text{ }^\circ\text{C}$ )**

J Series 2835 LEDs are tested for forward voltage and placed into one of the following voltage bins.

The following voltage bins are indicated in the Forward Voltage Bin field in the bin code for JE2835 3-V LEDs.

Voltage Bin	Minimum Forward Voltage (V)	Maximum Forward Voltage (V)
AF	2.9	3.0
AG	3.0	3.1
AH	3.1	3.2
AJ	3.2	3.3

The following voltage bins are indicated in the Forward Voltage Bin field in the bin code for JK2835 6-V LEDs.

Voltage Bin	Minimum Forward Voltage (V)	Maximum Forward Voltage (V)
BP	5.8	6.0
BQ	6.0	6.2
BR	6.2	6.4

**PERFORMANCE GROUPS - CHROMATICITY**

J Series 2835 LEDs are tested for chromaticity and placed into one of the regions defined by the following bounding coordinates.

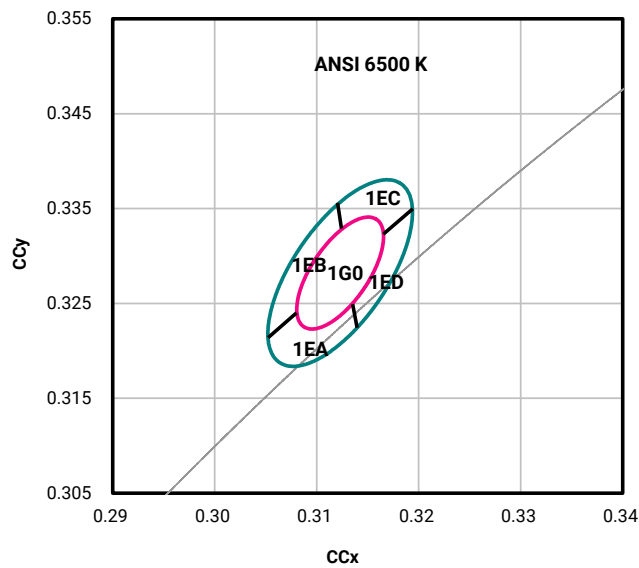
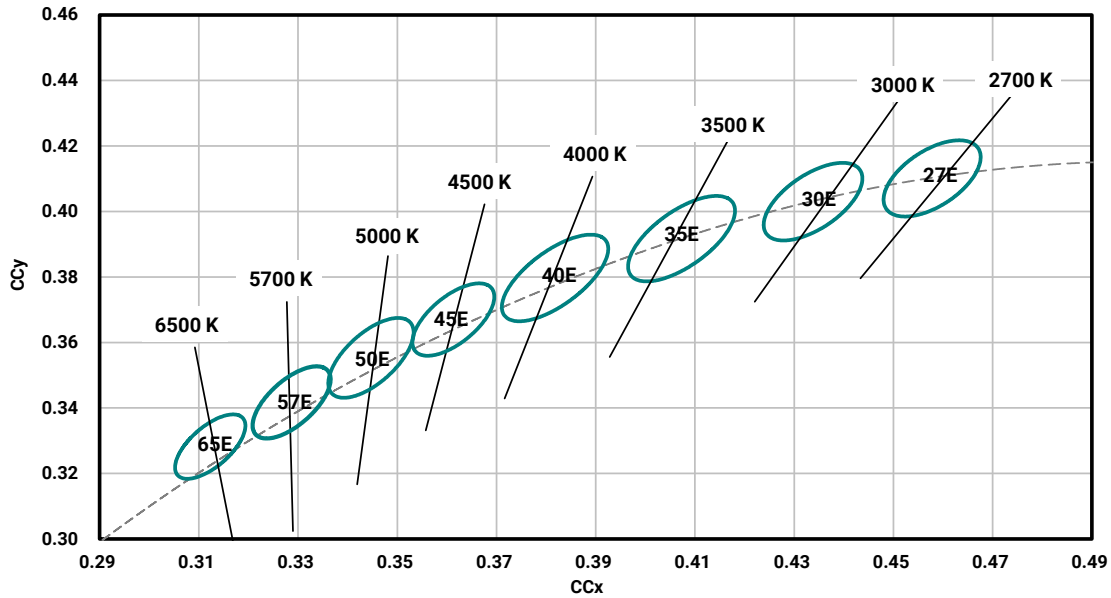

CCT	MacAdam Ellipse	Chromaticity Group	Included Bins	Center Point		Major Axis	Minor Axis	Rotation Angle (°)
				x	y	a	b	
6500 K	3-step	65G	1G0	0.3123	0.3282	0.00669	0.00285	58.57
	5-step	65E	1G0, 1EA, 1EB, 1EC, 1ED	0.3123	0.3282	0.01115	0.00475	58.57

**PERFORMANCE GROUPS - CHROMATICITY - CONTINUED**

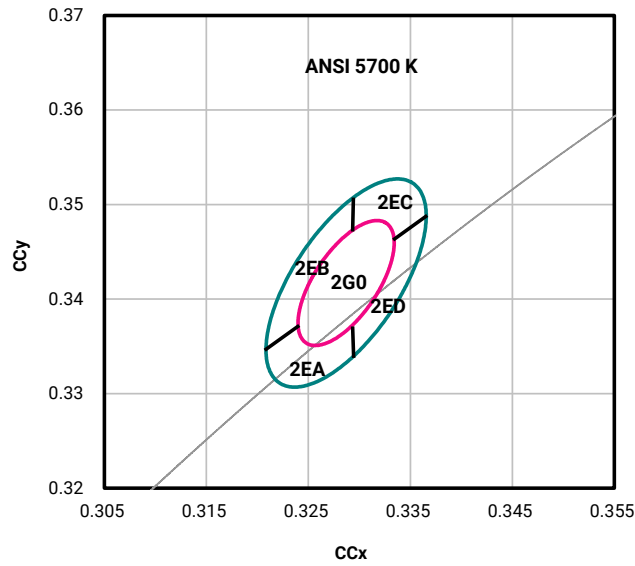

CCT	MacAdam Ellipse	Chromaticity Group	Included Bins	Center Point		Major Axis	Minor Axis	Rotation Angle (°)
				x	y	a	b	
5700 K	3-step	57G	2G0	0.3287	0.3417	0.00746	0.00320	59.09
	5-step	57E	2G0, 2EA, 2EB, 2EC, 2ED	0.3287	0.3417	0.01243	0.00533	59.09



**PERFORMANCE GROUPS - CHROMATICITY - CONTINUED**

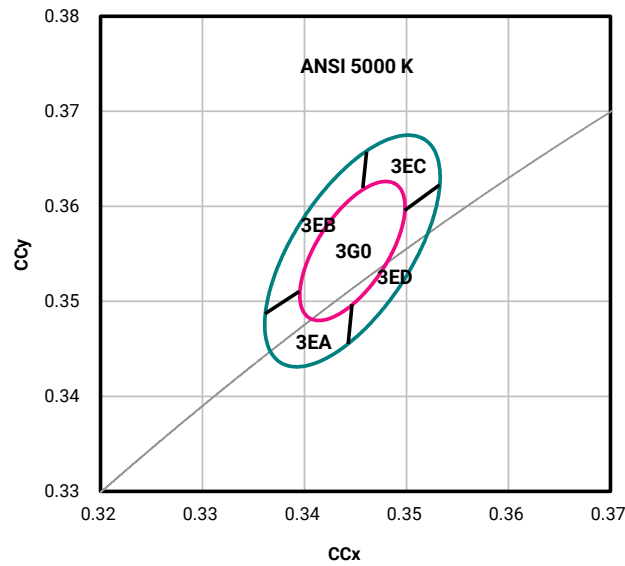

CCT	MacAdam Ellipse	Chromaticity Group	Included Bins	Center Point		Major Axis	Minor Axis	Rotation Angle (°)
				x	y	a	b	
5000 K	3-step	50G	3G0	0.3447	0.3553	0.00822	0.00354	59.62
	5-step	50E	3G0, 3EA, 3EB, 3EC, 3ED	0.3447	0.3553	0.01370	0.00590	59.62

**PERFORMANCE GROUPS - CHROMATICITY - CONTINUED**

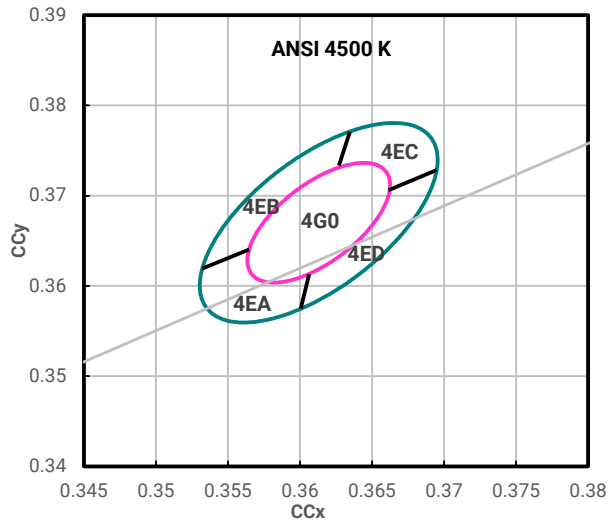

CCT	MacAdam Ellipse	Chromaticity Group	Included Bins	Center Point		Major Axis	Minor Axis	Rotation Angle (°)
				x	y	a	b	
4500 K	3-step	45G	4G0	0.3613	0.3670	0.00756	0.00338	57.58
	5-step	45E	4G0, 4EA, 4EB, 4EC, 4ED	0.3613	0.3670	0.01260	0.00563	57.58

**PERFORMANCE GROUPS - CHROMATICITY - CONTINUED**

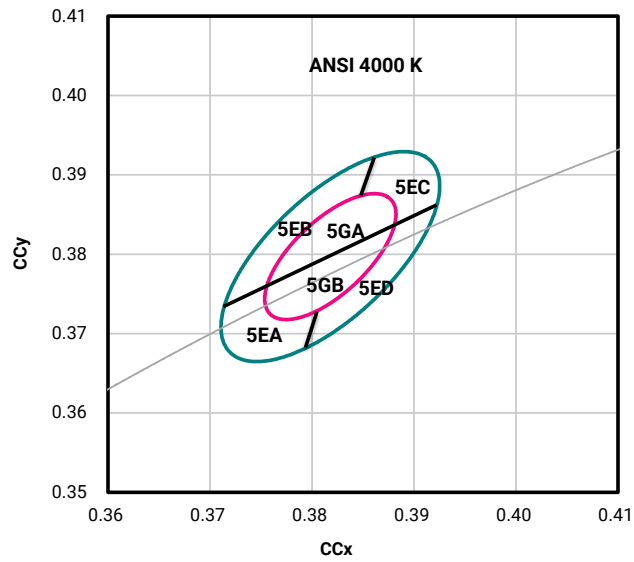

CCT	MacAdam Ellipse	Chromaticity Group	Included Bins	Center Point		Major Axis	Minor Axis	Rotation Angle (°)
				x	y	a	b	
4000 K	3-step	40G	5GA, 5GB	0.3818	0.3797	0.00939	0.00402	53.72
	5-step	40E	5GA, 5GB, 5EA, 5EB, 5EC, 5ED	0.3818	0.3797	0.01565	0.00402	53.72

**PERFORMANCE GROUPS - CHROMATICITY - CONTINUED**

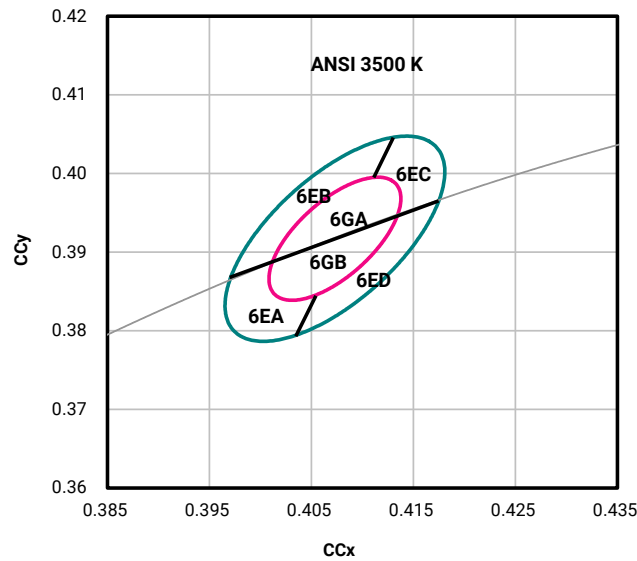

CCT	MacAdam Ellipse	Chromaticity Group	Included Bins	Center Point		Major Axis	Minor Axis	Rotation Angle (°)
				x	y	a	b	
3500 K	3-step	35G	6GA, 6GB	0.4073	0.3917	0.00927	0.00414	53.22
	5-step	35E	6GA, 6GB, 6EA, 6EB, 6EC, 6ED	0.4073	0.3917	0.01545	0.00690	53.22

**PERFORMANCE GROUPS - CHROMATICITY - CONTINUED**

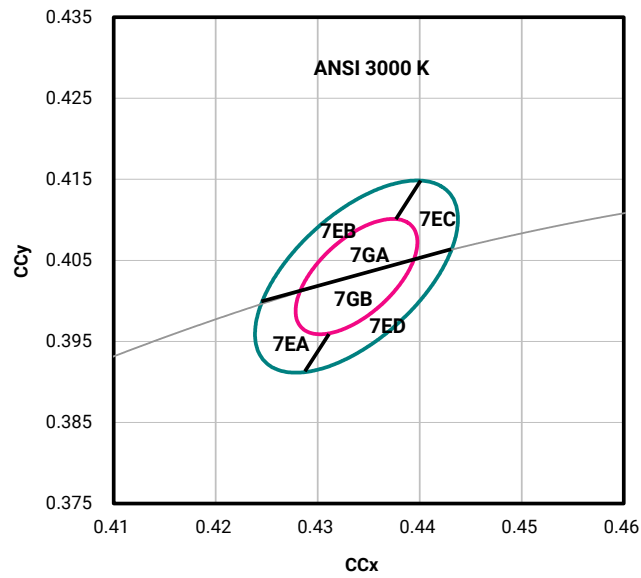

CCT	MacAdam Ellipse	Chromaticity Group	Included Bins	Center Point		Major Axis	Minor Axis	Rotation Angle (°)
				x	y	a	b	
3000 K	3-step	30G	7GA, 7GB	0.4338	0.4030	0.00834	0.00408	53.22
	5-step	30E	7GA, 7GB, 7EA, 7EB, 7EC, 7ED	0.4338	0.4030	0.01390	0.00680	53.22

**PERFORMANCE GROUPS - CHROMATICITY - CONTINUED**

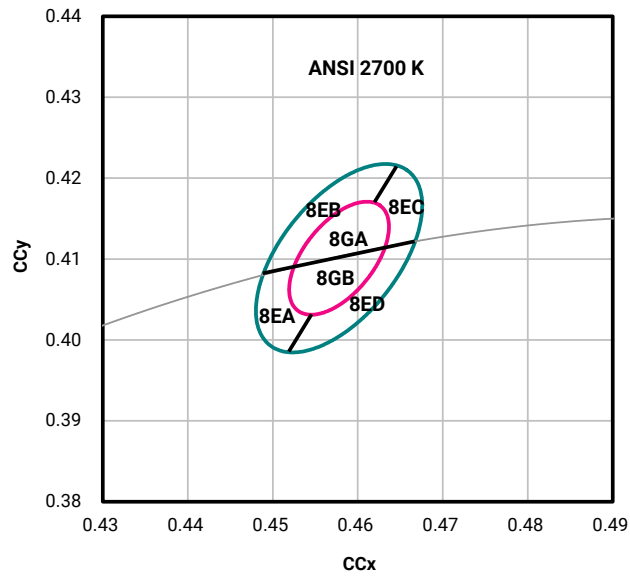

CCT	MacAdam Ellipse	Chromaticity Group	Included Bins	Center Point		Major Axis	Minor Axis	Rotation Angle (°)
				x	y	a	b	
2700 K	3-step	27G	8GA, 8GB	0.4578	0.4101	0.00810	0.00420	53.70
	5-step	27E	8GA, 8GB, 8EA, 8EB, 8EC, 8ED	0.4578	0.4101	0.01350	0.00700	53.70

**REFLOW SOLDERING CHARACTERISTICS**

In testing, Cree Venture has found J Series 2835 LEDs to be compatible with JEDEC J-STD-020C, using the parameters listed below. As a general guideline, CreeVenture recommends that users follow the recommended soldering profile provided by the manufacturer of the solder paste used, and therefore it is the lamp or luminaire manufacturer’s responsibility to determine applicable soldering requirements.

Note that this general guideline may not apply to all PCB designs and configurations of reflow soldering equipment.

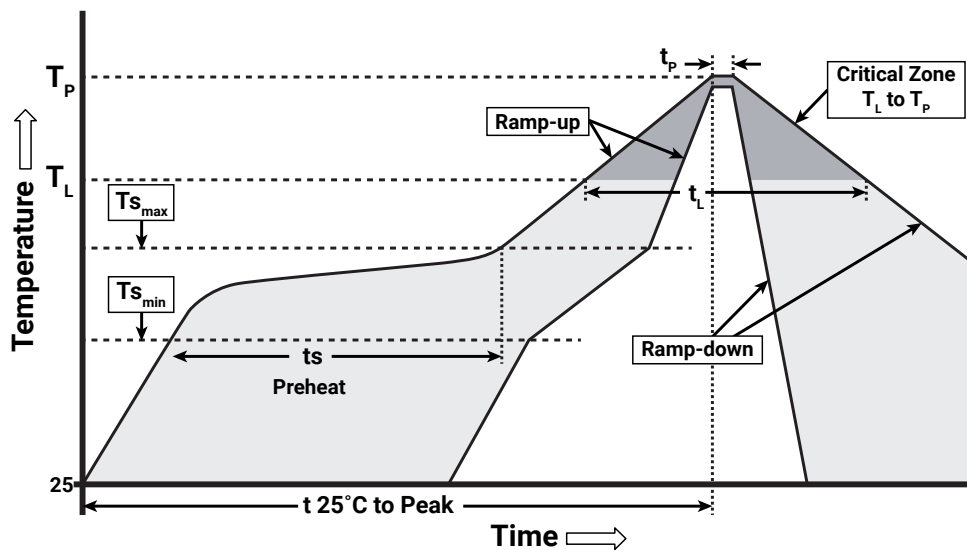

IPC/JEDEC J-STD-020C

Profile Feature	Lead-Free Solder
Temperature Min. ( $T_{s_{min}}$ )	150 °C
Temperature Max. ( $T_{s_{max}}$ )	200 °C
Time ( $t_s$ ) from $T_{s_{min}}$ to $T_{s_{max}}$	60-120 seconds
Ramp-Up Rate ( $T_L$ to $T_P$ )	3 °C/second
Liquidus Temperature ( $T_L$ )	217 °C
Time ( $t_l$ ) Maintained Above $T_L$	60-150 seconds
Peak Package Body Temperature ( $T_p$ )	260 °C max.
Time ( $t_p$ ) Within 5 °C of the Specified Classification Temperature ( $T_c$ )	30 seconds max.
Ramp-Down Rate ( $T_p$ to $T_L$ )	6 °C/second max.
Time 25 °C to Peak Temperature	8 minutes max.

Note: All temperatures refer to the topside of the package, measured on the package body surface.

**NOTES**

**Measurements**

The luminous flux, radiant power, chromaticity, forward voltage and CRI measurements in this document are binning specifications only and solely represent product measurements as of the date of shipment. These measurements will change over time based on a number of factors that are not within Cree Venture’s control and are not intended or provided as operational specifications for the products. Calculated values are provided for informational purposes only and are not intended or provided as specifications.

**Pre-Release Qualification Testing**

Please read the [J Series Reliability Overview](#) for the details of the pre-release qualification testing for J Series LEDs.

**Lumen Maintenance**

Cree Venture uses standardized IES LM-80-08 and TM-21-11 methods for collecting long-term data and extrapolating LED lumen maintenance. For information on the specific LM-80 data sets available for this LED, refer to the public [J Series LM-80 results document](#).

Please read the [Thermal Management application note](#) for details on how thermal design, ambient temperature, and drive current affect the LED junction temperature.

**Moisture Sensitivity**

Cree Venture recommends keeping J Series 2835 LEDs in the provided, resealable moisture-barrier packaging (MBP) until immediately prior to soldering. Unopened MBP that contains J Series 2835 LEDs does not need special storage for moisture sensitivity.

Once the MBP is opened, J Series 2835 LEDs should be handled and stored as MSL 3 per JEDEC J-STD-033, meaning they have limited exposure time before damage to the LED may occur during the soldering operation. The table on the right specifies the maximum exposure time in days depending on temperature and humidity conditions. LEDs with exposure time longer than the specified maximums must be baked according to the baking conditions listed below.

Moisture Sensitivity Level	Temp.	Maximum Percent Relative Humidity				
		50%	60%	70%	80%	90%
Level 3	35 °C	8	5	1	0.5	0.5
Level 3	30 °C	11	7	1	1	1
Level 3	25 °C	14	10	2	1	1
Level 3	20 °C	20	13	2	1	1

**Baking Conditions**

It is not necessary to bake all J Series 2835 LEDs. Only the LEDs that meet all of the following criteria must be baked:

1. LEDs that have been removed from the original MBP.
2. LEDs that have been exposed to a humid environment longer than listed in the Moisture Sensitivity section above.
3. LEDs that have not been soldered.

LEDs should be baked at 60 °C for 24 hours. LEDs may be baked in the original reels. Remove LEDs from the MBP before baking. Do not bake parts at temperatures higher than 60 °C. This baking operation resets the exposure time as defined in the Moisture Sensitivity section above.



## NOTES - CONTINUED

---

### RoHS Compliance

The levels of RoHS restricted materials in this product are below the maximum concentration values (also referred to as the threshold limits) permitted for such substances, or are used in an exempted application, in accordance with EU Directive 2011/65/EC (RoHS2), as implemented January 2, 2013. RoHS Declarations for this product can be obtained from your Cree representative or from the [Product Ecology](#) section of the Cree website.

### REACH Compliance

REACH substances of very high concern (SVHCs) information is available for this product. Since the European Chemical Agency (ECHA) has published notice of their intent to frequently revise the SVHC listing for the foreseeable future, please contact a Cree representative to insure you get the most up-to-date REACH SVHC Declaration. REACH banned substance information (REACH Article 67) is also available upon request.

### UL® Recognized Component

This product meets the requirements to be considered a UL Recognized Component with Level 4 enclosure consideration. The LED package or a portion thereof has been investigated as a fire and electrical enclosure per ANSI/UL 8750.

### Vision Advisory

**WARNING:** Do not look at an exposed lamp in operation. Eye injury can result. For more information about LEDs and eye safety, please refer to the [J Series LED Eye Safety application note](#).

**MECHANICAL DIMENSIONS**

Thermal vias, if present, are not shown on these drawings.  
All measurements are ±0.2 mm unless otherwise indicated.

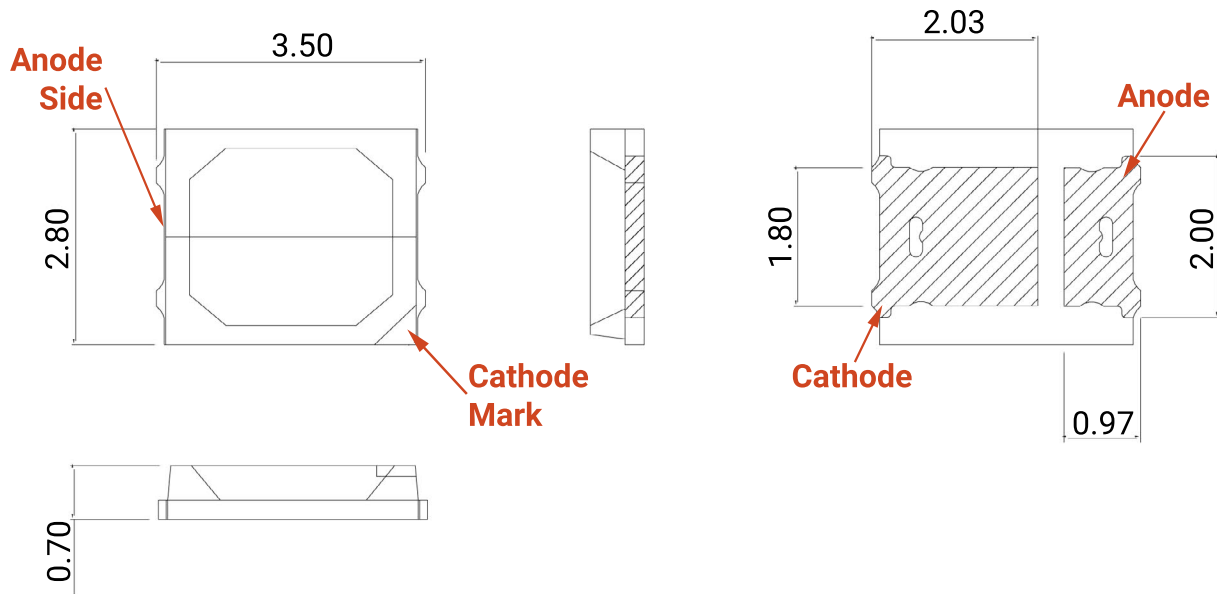

All measurements are ±0.1 mm unless otherwise indicated.

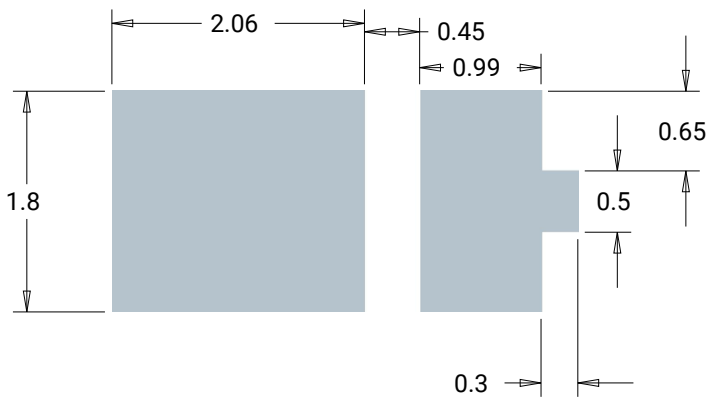

**Recommended Solder Pad**

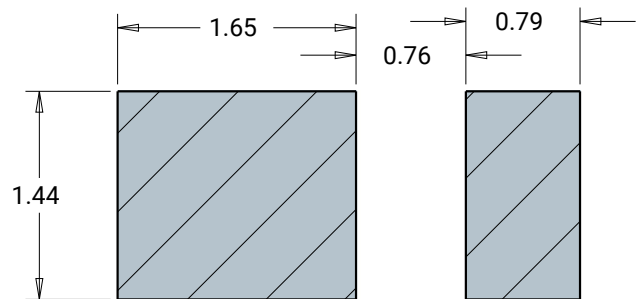

**Recommended Stencil Pattern  
(Hatched Area Is Open)**

**TAPE & REEL**

All Cree Venture carrier tapes conform to EIA-481D, Automated Component Handling Systems Standard.

All dimensions in mm.

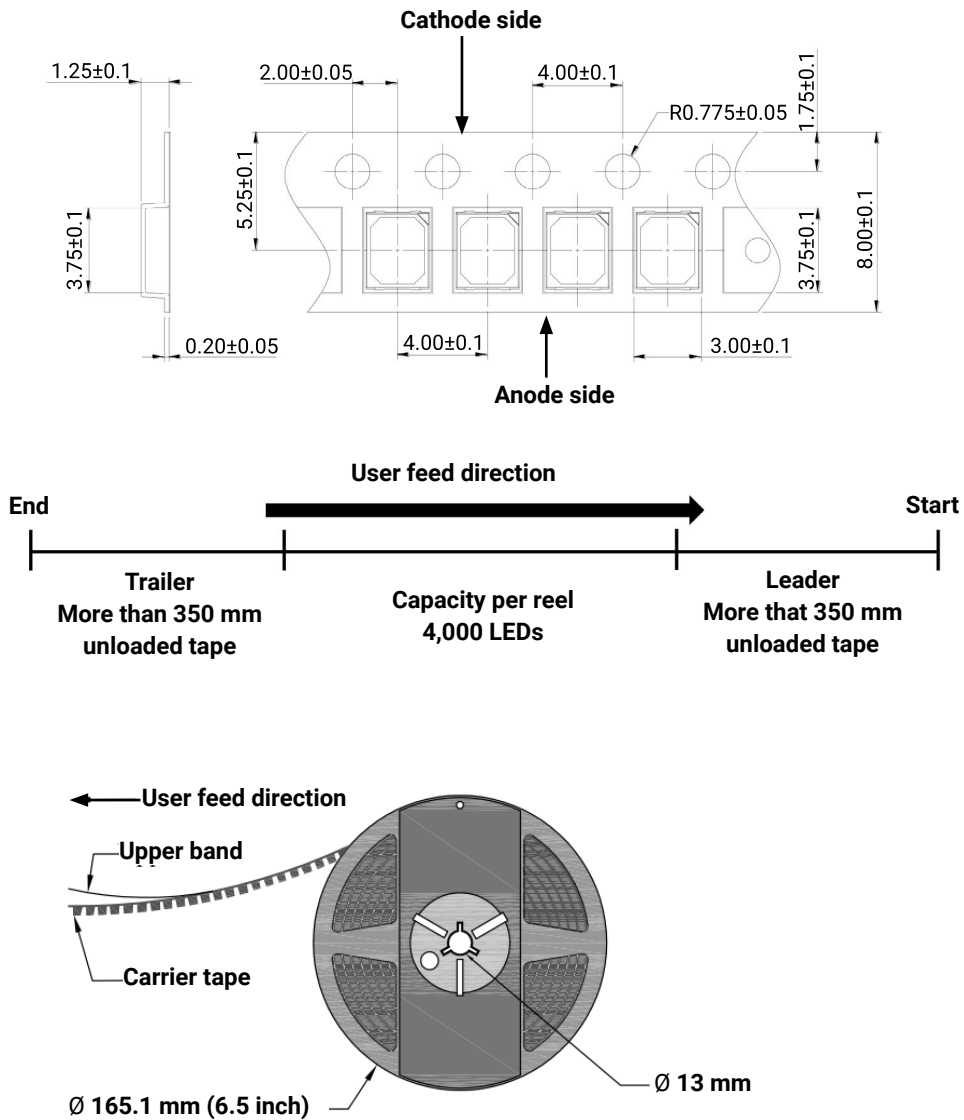

**PACKAGING**

---

**Unpackaged Reel**

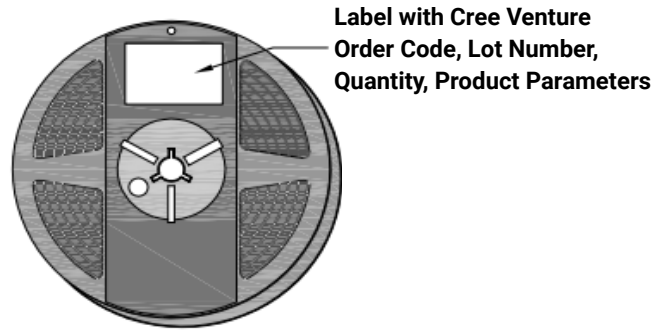

**Packaged Reel**

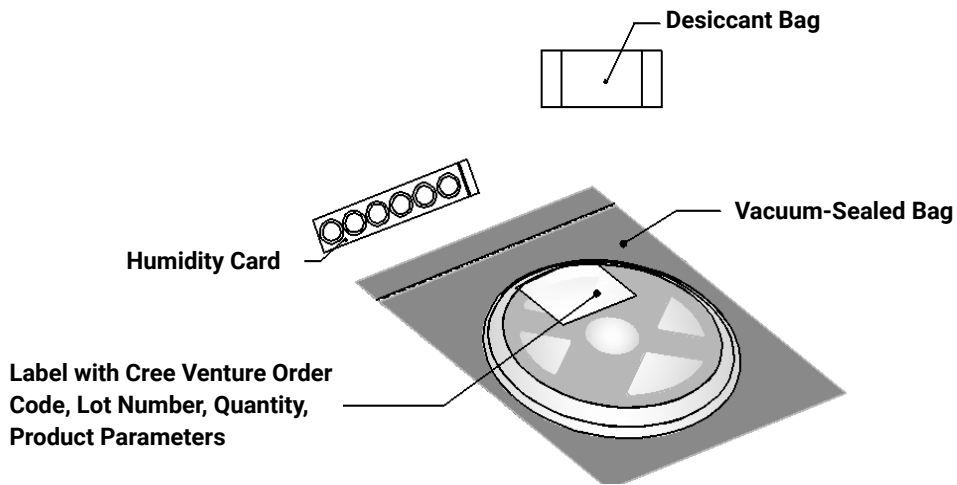

**PACKAGING - CONTINUED**

J Series 2835 LEDs are packaged in boxes for shipment. Box sizes and the number of reels per box are as follows.

Box	Box Dimensions	Number of Reels per Box
1	250 x 210 x 30 mm	2
2	250 x 210 x 50 mm	4
3	530 x 230 x 275 mm	44
4	530 x 443 x 275 mm	88

Each box has at least one label (shown as a white square in the diagrams below) showing the order code, lot number, quantity, and product parameters.

**Box 1**

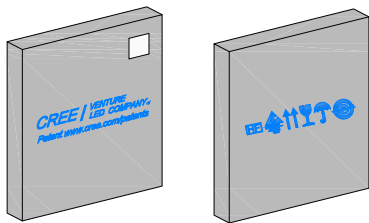

**Box 2**

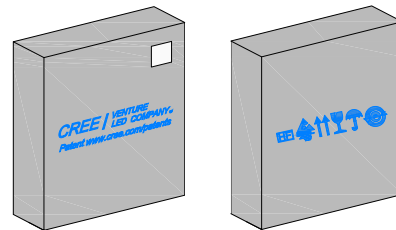

**Box 3**

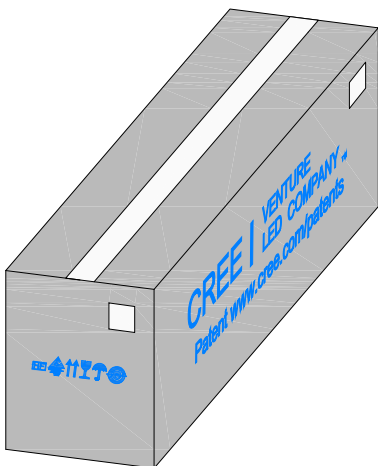

**Box 4**

