

**Ultra Fine Pitch (0.4mm), Ultra Low Profile (1mm)  
IDC Connector for Micro Coaxial Cable (#42 AWG)**

**USL**SERIES

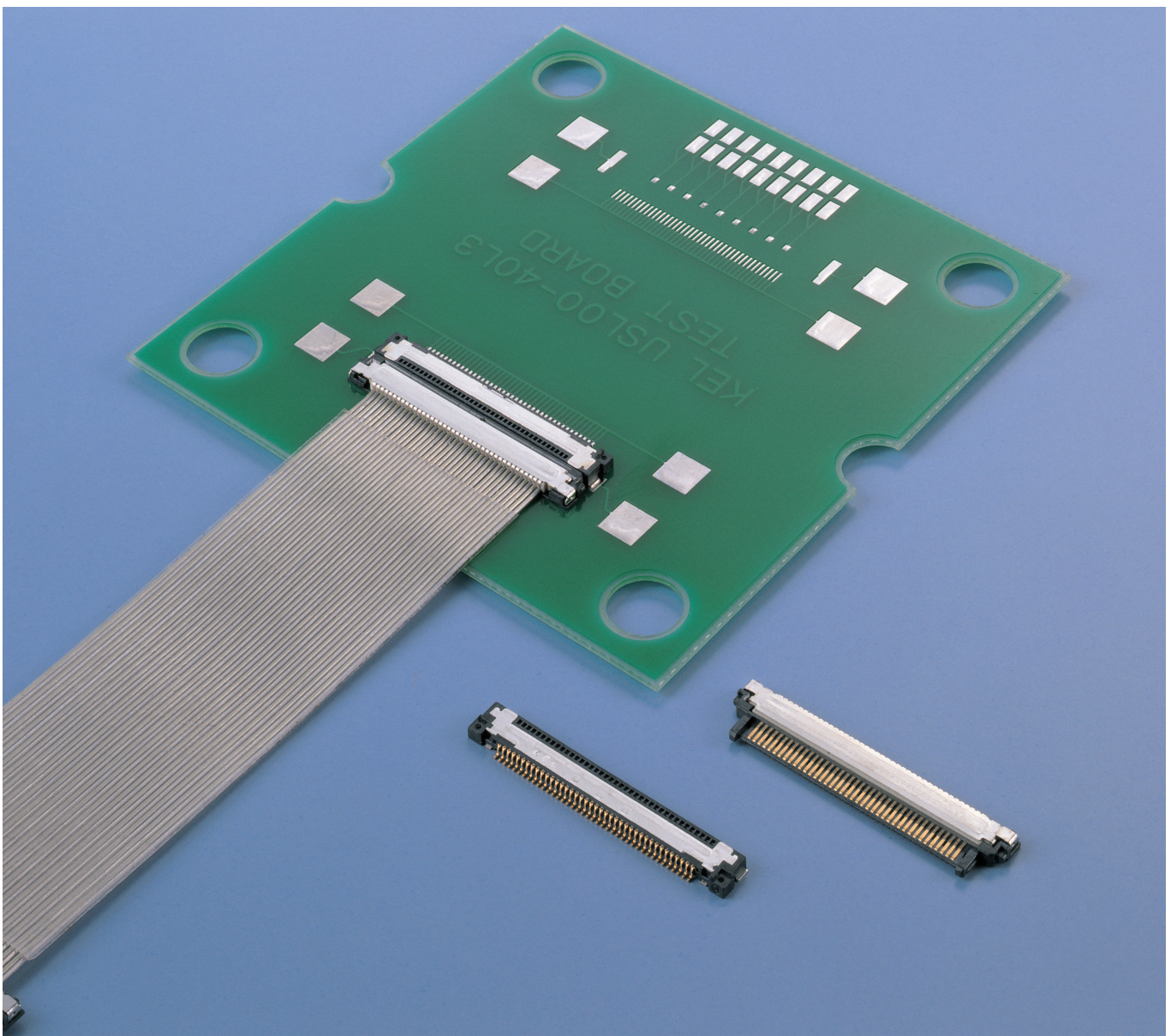

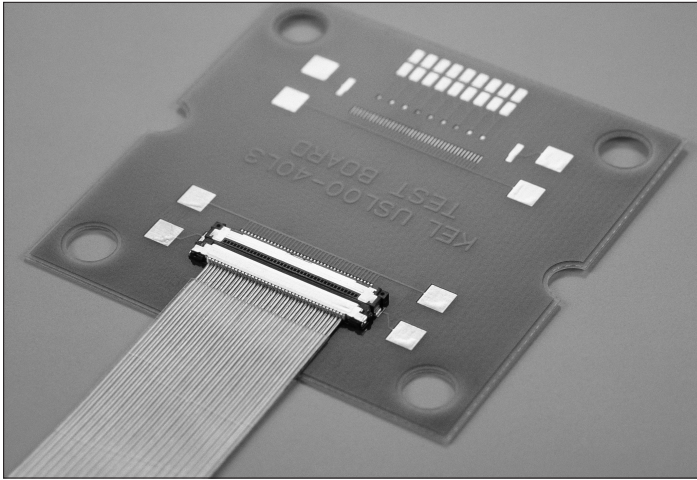

## FEATURES

- Ultra fine pitch 0.4mm
- Low profile 1mm
- More than 50% space saving compared to our SSL Series (0.5mm pitch)
- For micro coaxial cable (#42AWG)
- Metal shell on connector provides excellent EMI protection and mechanical strength
- IDC cable assembly (No solder connection)
- RoHS compliance

## SPECIFICATIONS

- |                                   |                                     |
|-----------------------------------|-------------------------------------|
| ● Insulator material              | : Glass-filled LCP (UL94V-0), Black |
| ● Contact material                | : Copper alloy                      |
| ● Contact plating                 | : Gold over Nickel                  |
| ● Shell material                  | : Copper alloy                      |
| ● Shell plating                   | : Tin copper over Nickel            |
| ● IDC cover material              | : Glass-filled LCP (UL94V-0), White |
| ● Current rating                  | : 0.25A per contact                 |
| ● Contact resistance              | : 100mΩ max.                        |
| ● Dielectric withstanding voltage | : 200V AC for 1 minute              |
| ● Insulation resistance           | : 100MΩ min. at 250V DC             |
| ● Operating temperature           | : -40°C to +85°C                    |

\* The base and cover for the plug are sold separately. Please contact sales for inquiries and orders.

### ORDER CODE

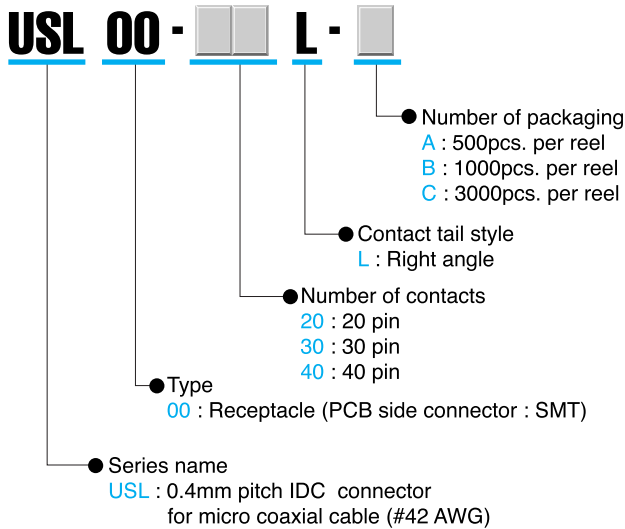

### ORDER CODE

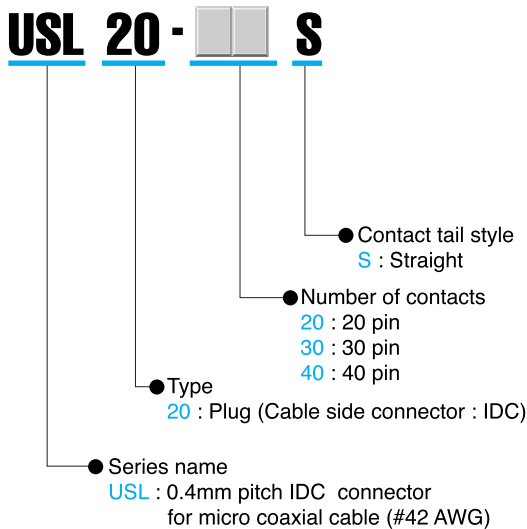

## USL00-□□L-□ (Receptacle)

Unit:mm(inch)

Receptacle (Right angle)

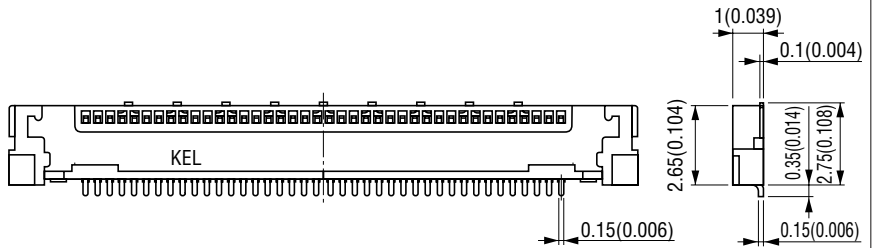
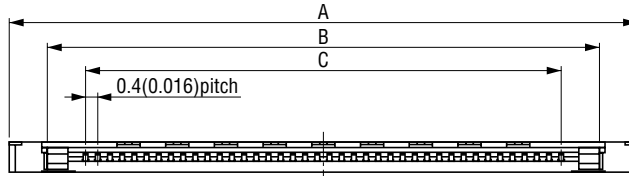
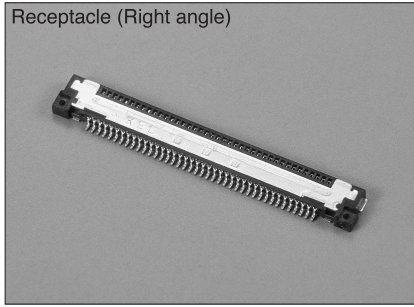
 Packaging style  
 Embossed tape

Part Number	Number of packaging
USL00-□□L-A	500
USL00-□□L-B	1,000
USL00-□□L-C	3,000

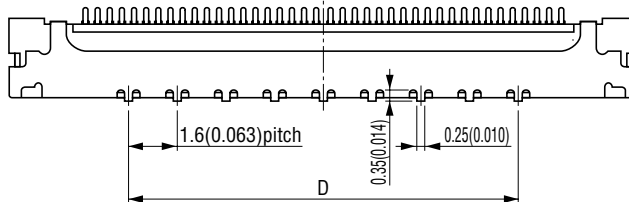
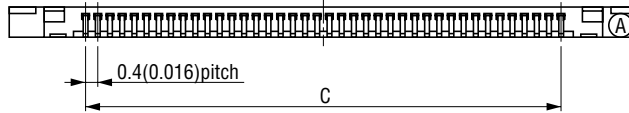
**Product Table / Dimensions**

No. of contacts	Part Number	A	B	C	D	E	F
20	USL00-20L-□	12.6 (0.496)	10.1 (0.398)	7.6 (0.299)	6.4 (0.252)	0.6 (0.024)	12.8 (0.504)
30	USL00-30L-□	16.6 (0.654)	14.1 (0.555)	11.6 (0.457)	9.6 (0.378)	1.0 (0.039)	16.8 (0.661)
40	USL00-40L-□	20.6 (0.811)	18.1 (0.713)	15.6 (0.614)	12.8 (0.504)	1.4 (0.055)	20.8 (0.819)

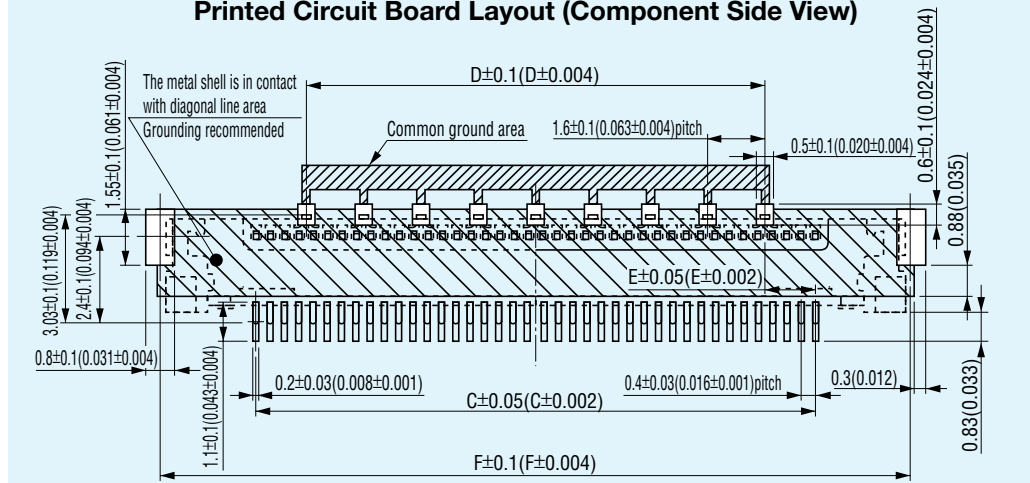
**Printed Circuit Board Layout (Component Side View)**



### USL20-□□S (Plug)

Unit:mm(inch)

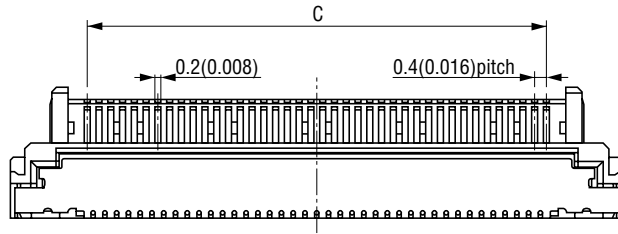
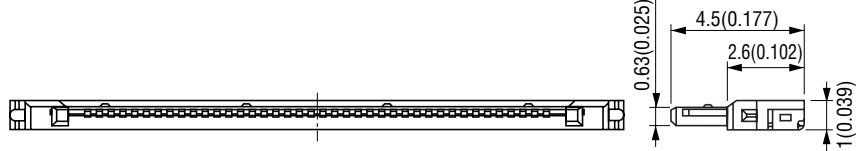
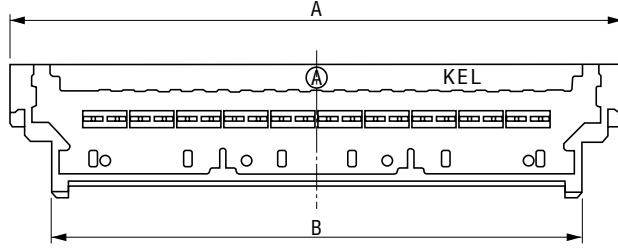
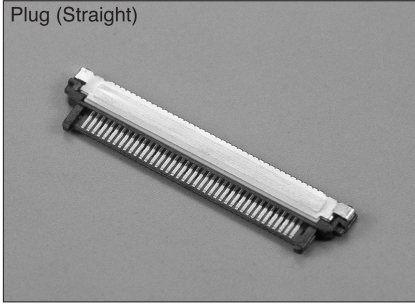

Packaging style
Tray

■ Product Table / Dimensions

No. of contacts	Part Number	A	B	C	Number of packaging
20	USL20-20S	12.8 (0.504)	10.1 (0.398)	7.6 (0.299)	160
30	USL20-30S	16.8 (0.661)	14.1 (0.555)	11.6 (0.457)	120
40	USL20-40S	20.8 (0.819)	18.1 (0.713)	15.6 (0.614)	100

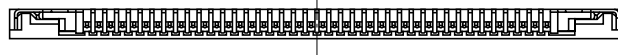

### Mating Variation

Unit:mm(inch)

X-X' Cross Section

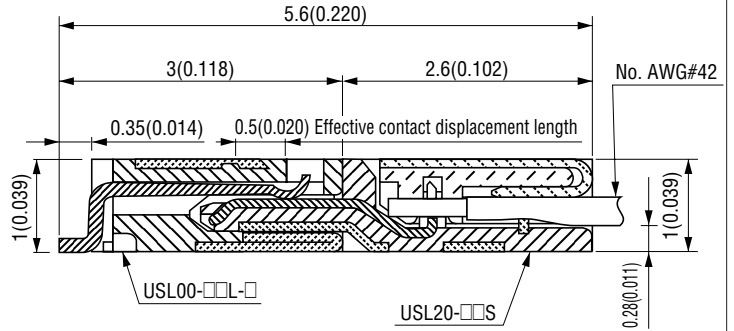
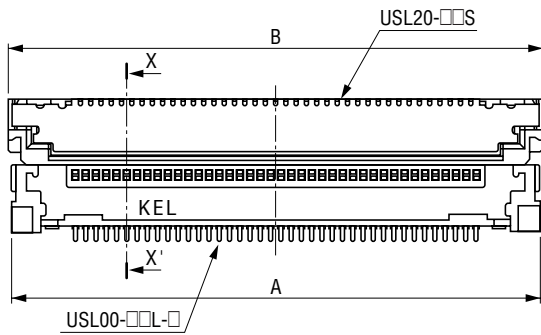

■ Number of Contact / Dimensions

No. of contact	A	B
20	12.6 (0.496)	12.8 (0.504)
30	16.6 (0.654)	16.8 (0.661)
40	20.6 (0.811)	20.8 (0.819)

● ORDER CODE

**USL 20- [ ] [ ] [ ] SS- [ ] [ ] [ ] -B [ ]**

- Series name  
USL : 0.4mm pitch IDC connector for micro coaxial cable (#42 AWG)
- Type  
20 : Plug / Cable connection type
- Number of contacts  
20 : 20 pin  
30 : 30 pin  
40 : 40 pin
- Connector style (Left side, CN1)  
S : Straight
- Connector style (Right side, CN2)  
S : Straight
- Cable length (cm)  
L : dimension (Example : 015=15cm)
- Wiring code  
B : Pin 1 to Pin 1
- Holding tape  
Omit : Without tape  
H : With tape

● ORDER CODE

**USL 20- [ ] [ ] [ ] SS- [ ] [ ] [ ] -C [ ]**

- Series name  
USL : 0.4mm pitch IDC connector for micro coaxial cable (#42 AWG)
- Type  
20 : Plug / Cable connection type
- Number of contacts  
20 : 20 pin  
30 : 30 pin  
40 : 40 pin
- Connector style (Left side, CN1)  
S : Straight
- Connector style (Right side, CN2)  
S : Straight
- Cable length (cm)  
L : dimension (Example : 015=15cm)
- Wiring code  
C : Pin 1 to Pin n
- Holding tape  
Omit : Without tape  
H : With tape

Unit : mm(inch)

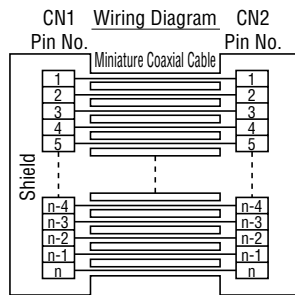
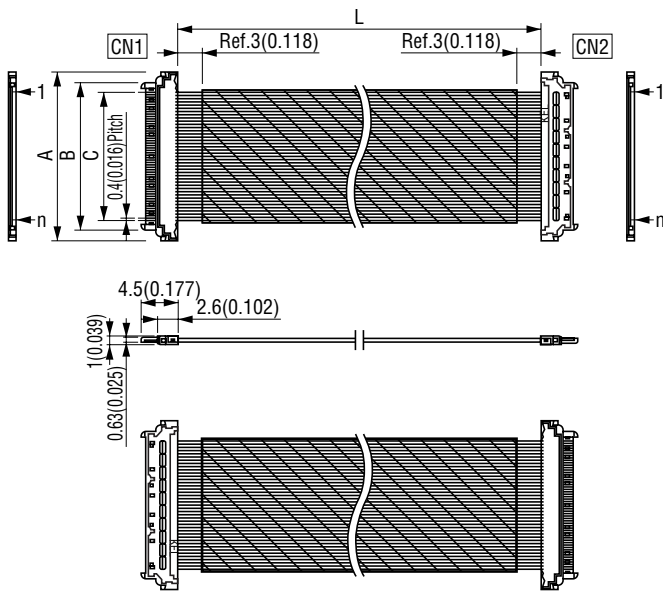

\* "n" is number of contacts.

■ Number of Contact / Dimensions

No. of contacts	Part Number	A	B	C
20	USL20-20SS-[ ]-[ ]-B[ ]	12.8(0.504)	10.1(0.398)	7.6(0.299)
30	USL20-30SS-[ ]-[ ]-B[ ]	16.8(0.661)	14.1(0.555)	11.6(0.457)
40	USL20-40SS-[ ]-[ ]-B[ ]	20.8(0.819)	18.1(0.713)	15.6(0.614)

Unit : mm(inch)

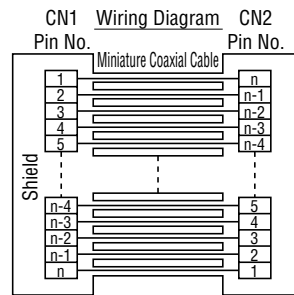
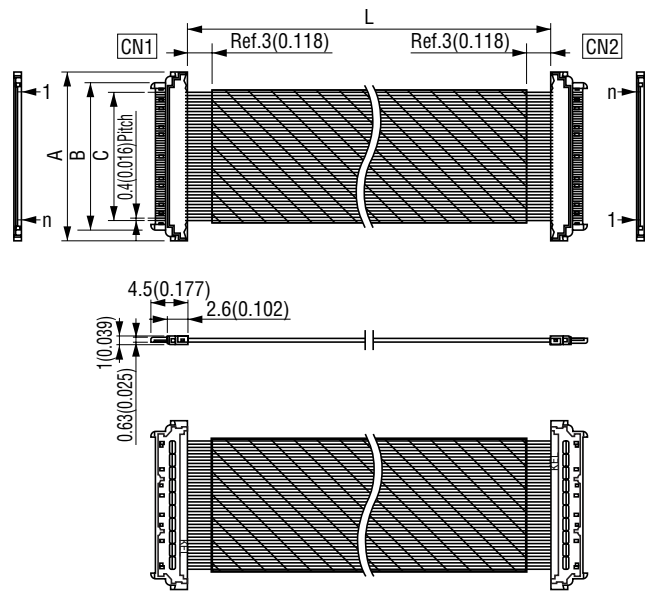

\* "n" is number of contacts.

■ Number of Contact / Dimensions

No. of contacts	Part Number	A	B	C
20	USL20-20SS-[ ]-[ ]-C[ ]	12.8(0.504)	10.1(0.398)	7.6(0.299)
30	USL20-30SS-[ ]-[ ]-C[ ]	16.8(0.661)	14.1(0.555)	11.6(0.457)
40	USL20-40SS-[ ]-[ ]-C[ ]	20.8(0.819)	18.1(0.713)	15.6(0.614)

※Specifications and dimensions are subject to change without notice.