

REV.	DESCRIPTION	DRAWN	CHECKED	APPROVED
A	NEW RELEASE	YCH 06/12/07'	~	

N=NUMBER OF CONTACTS

1. PRODUCT NUMBER CODE:

DS1015-03 -XX R X A X - X - X

CABLE STYLE  
A: TYPE A

LENGTH DIM L  
0150: L=150mm

WIRE DIAMETER  
1:∅0.100 FOLWER MARK  
2:∅0.127 RED MARK  
3:∅0.100 RED MARK  
4:∅0.127 FOLWER MARK

FLAT CABLE COLOR  
A: GRAY

CONTACT PLATING  
2: GOLD+NICKEL  
6: FULL TIN  
8: FULL GOLD FLASH

HOUSING COLOR  
R:RED

NO.OF CONTACTS  
04 06 08 10 12  
14 16 18 20 24

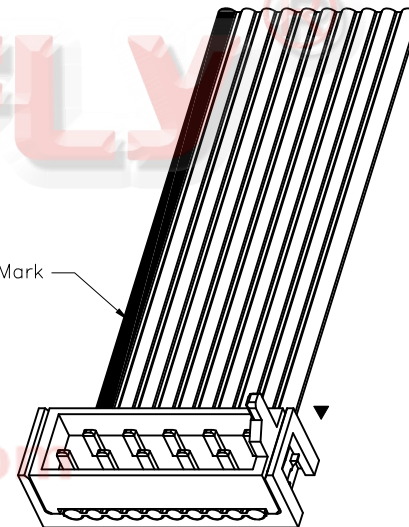
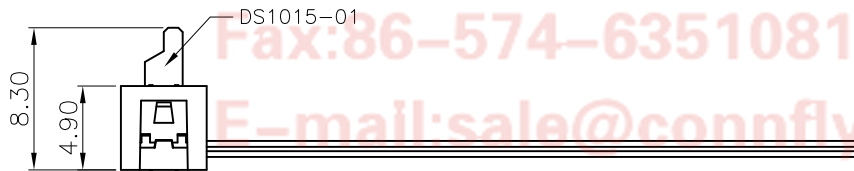
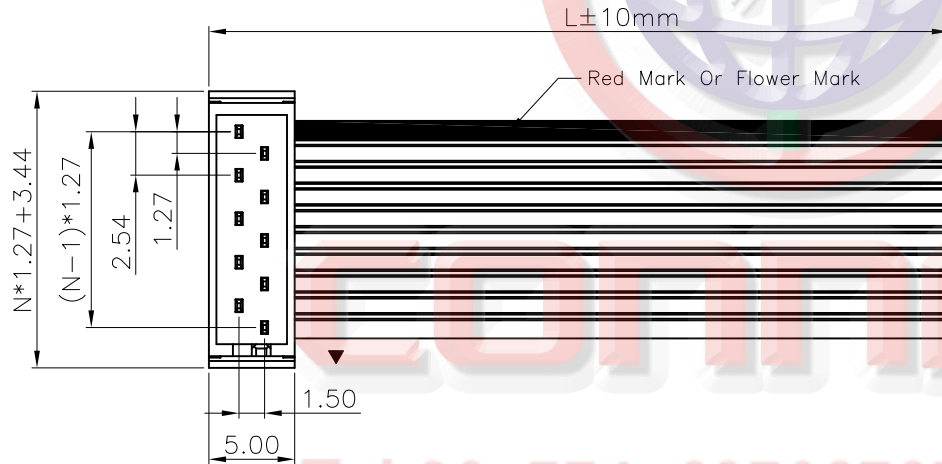

Tel:86-574-63508787  
 Fax:86-574-63510817  
 E-mail:sale@connfly.com  
 http://www.connfly.com  
 Add:East Industry Zone KuangYan  
 Town Cixi Ningbo China  
 P.C:315333

GENERAL TOLERANCE		ANGLE TOLERANCE	
X.	±15	X.	±3°
.X	±10	.X	±2°
.XX	±5	.XX	±1°

PROJECTION	TITLE
UNITS	DS1015-03 (1*DS1015-01)
SHEET SIZE	SERIES DS1015-03 SERIES

DRAWING TYPE	CUSTOMER
SCALE	1:1 SHEET 1 OF 1
DRAWING NO.	C-DS1015-03-XXXXXXA

 晨翔电子有限公司  
**CONNFLY CONNFLY ELECTRONIC CO. LTD**

REV.	DESCRIPTION	DRAWN	CHECKED	APPROVED
A	NEW RELEASE	YCH 06/12/07'	~	

N=NUMBER OF CONTACTS

1. PRODUCT NUMBER CODE:  
DS1015-03 -XX R X A X - X - X

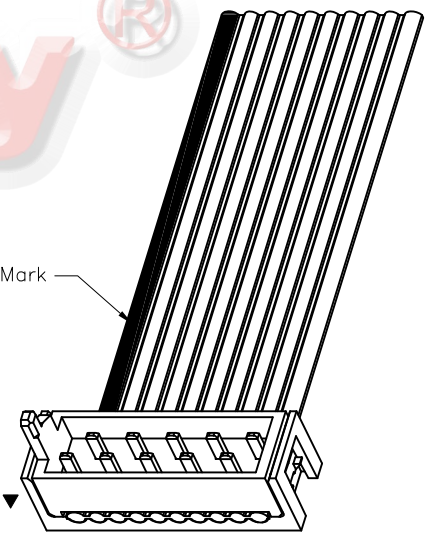
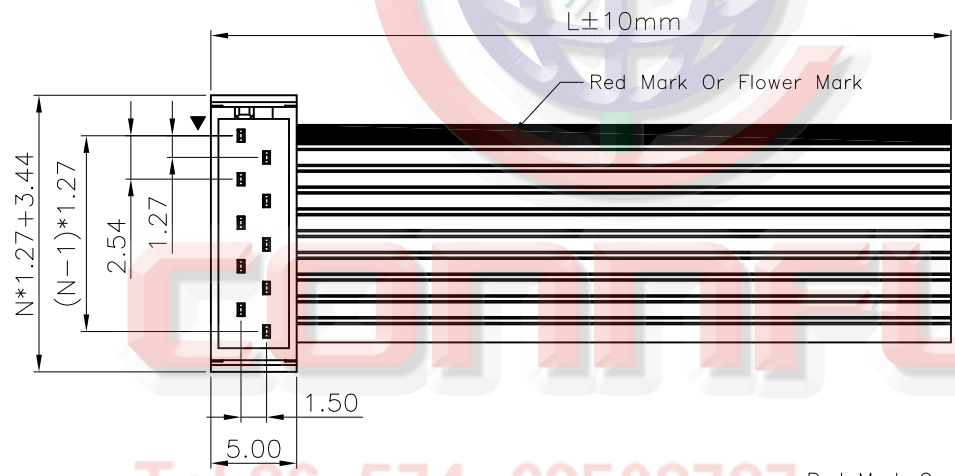

- CABLE STYLE  
B: TYPE B
- LENGTH DIM L  
0150: L=150mm
- WIRE DIAMETER  
1:  $\phi 0.100$  FOLWER MARK  
2:  $\phi 0.127$  RED MARK  
3:  $\phi 0.100$  RED MARK  
4:  $\phi 0.127$  FOLWER MARK
- FLAT CABLE COLOR  
A: GRAY
- CONTACT PLATING  
2: GOLD+NICKEL  
6: FULL TIN  
8: FULL GOLD FLASH
- HOUSING COLOR  
R: RED
- NO.OF CONTACTS  
04 06 08 10 12  
14 16 18 20 24

Tel:86-574-63508787

Fax:86-574-63510817

E-mail:sale@connfly.com

<http://www.connfly.com>

Add:East Industry Zone KuangYan

Town Cixi Ningbo China

P.C:315333

GENERAL TOLERANCE		ANGLE TOLERANCE		PROJECTION	TITLE	
X.	$\pm 15$	X.	$\pm 3^\circ$		DS1015-03 (1*DS1015-01)	
.X	$\pm 10$	.X	$\pm 2^\circ$	UNITS	mm	
.XX	$\pm 5$	.XX	$\pm 1^\circ$	SHEET SIZE	A4	
DRAWING TYPE		CUSTOMER		SERIES	DS1015-03 SERIES	
SCALE		1:1		SHEET 1 OF 1		
DRAWING NO.		C-DS1015-03-XXXXXXB				

**晨翔电子有限公司**  
**CONNFLY CONNFLY ELECTRONIC CO. LTD**

REV.	DESCRIPTION	DRAWN	CHECKED	APPROVED
A	NEW RELEASE	YCH 06/12/07'	~	

N=NUMBER OF CONTACTS

1. PRODUCT NUMBER CODE:

DS1015-03 -XX R X A X - X - X

CABLE STYLE  
C: TYPE C

LENGTH DIM L  
0150: L=150mm

WIRE DIAMETER  
1:∅0.100 FOLWER MARK  
2:∅0.127 RED MARK  
3:∅0.100 RED MARK  
4:∅0.127 FOLWER MARK

FLAT CABLE COLOR  
A: GRAY

CONTACT PLATING  
2: GOLD+NICKEL  
6: FULL TIN  
8: FULL GOLD FLASH

HOUSING COLOR  
R:RED

NO.OF CONTACTS  
04 06 08 10 12  
14 16 18 20 24

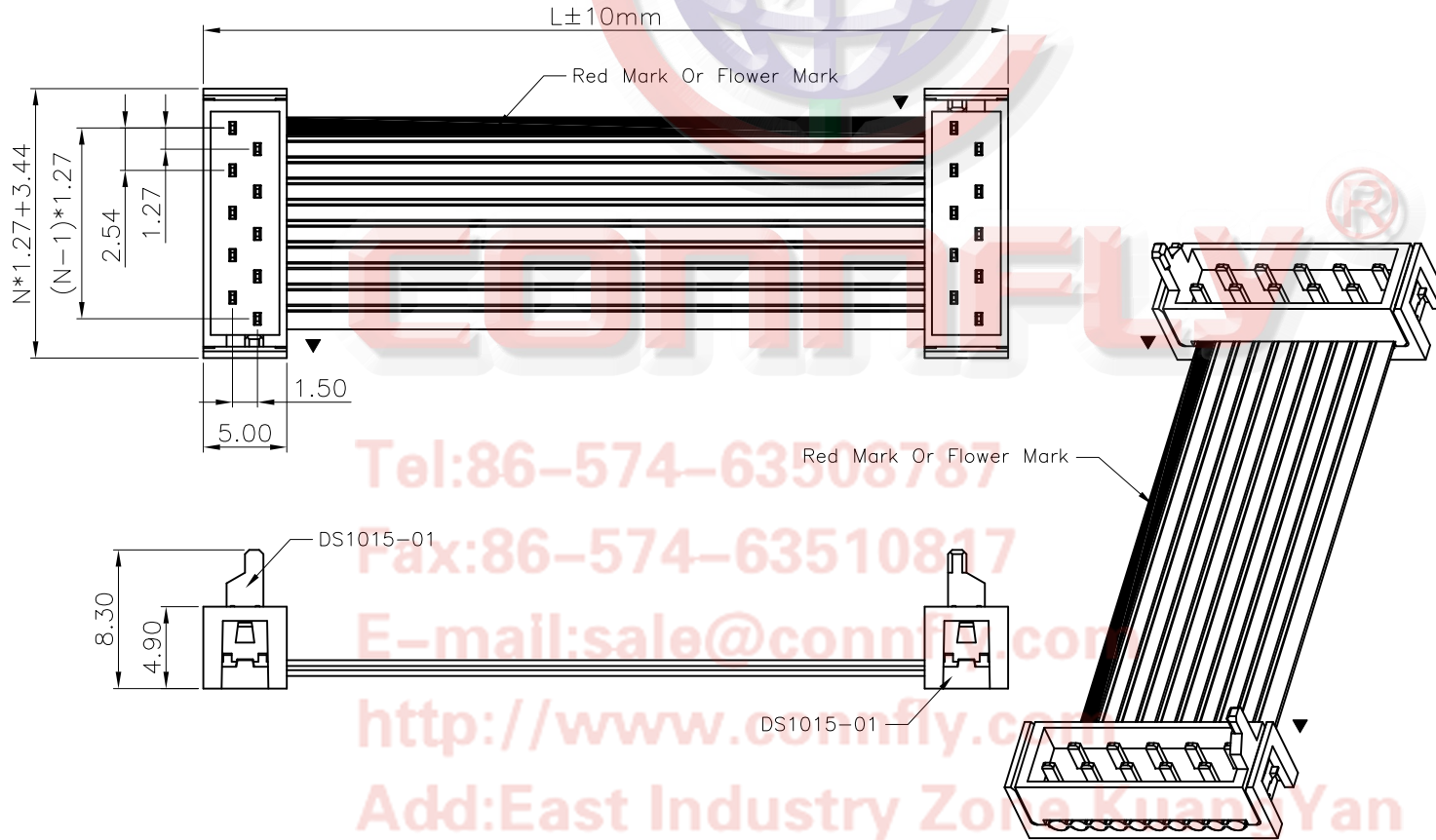

Tel:86-574-63508787  
 Fax:86-574-63510817  
 E-mail:sale@connfly.com  
 http://www.connfly.com  
 Add:East Industry Zone Kuan Yan  
 Town Cixi Ningbo China  
 P.C:315333

GENERAL TOLERANCE		ANGLE TOLERANCE	
X.	±15	X.	±3°
.X	±10	.X	±2°
.XX	±5	.XX	±1°

PROJECTION	TITLE
	DS1015-03 (2*DS1015-01)
UNITS	mm
SHEET SIZE	A4
SERIES	DS1015-03 SERIES

DRAWING TYPE	CUSTOMER
SCALE	1:1 SHEET 1 OF 1
DRAWING NO.	C-DS1015-03-XXXXXXC

晨翔电子有限公司  
**CONNFLY CONNFLY ELECTRONIC CO. LTD**

REV.	DESCRIPTION	DRAWN	CHECKED	APPROVED
A	NEW RELEASE	YCH 06/12/07'	~	

N=NUMBER OF CONTACTS

1. PRODUCT NUMBER CODE:

DS1015-03 -XX R X A X - X - X

CABLE STYLE  
D: TYPE D

LENGTH DIM L  
0150: L=150mm  
0710: L=710mm

WIRE DIAMETER  
1:∅0.100 FOLWER MARK  
2:∅0.127 RED MARK  
3:∅0.100 RED MARK  
4:∅0.127 FOLWER MARK

FLAT CABLE COLOR  
A: GRAY

CONTACT PLATING  
2: GOLD+NICKEL  
6: FULL TIN  
8: FULL GOLD FLASH

HOUSING COLOR  
R:RED

NO.OF CONTACTS  
04 06 08 10 12  
14 16 18 20 24

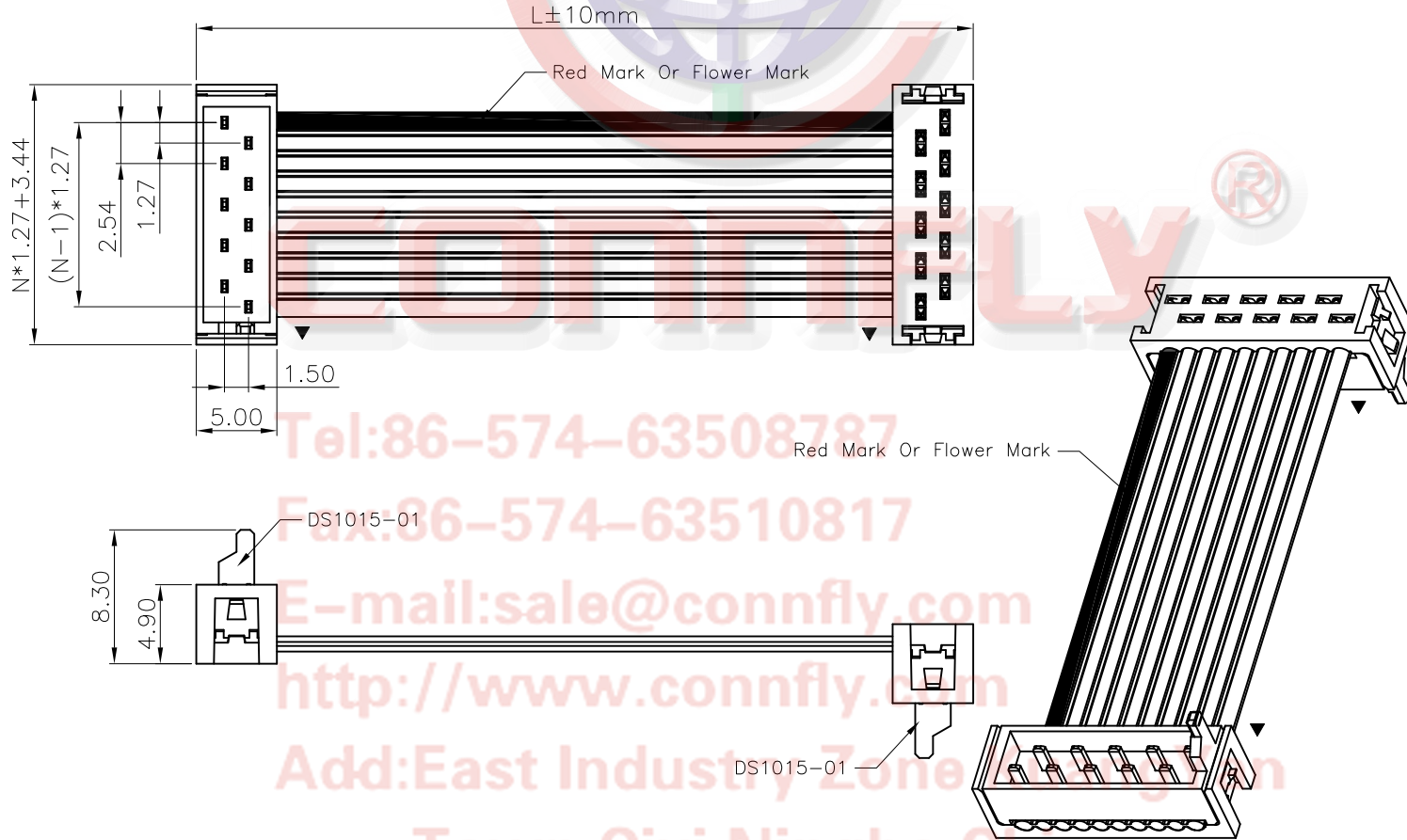

Tel:86-574-63508787  
Fax:86-574-63510817  
E-mail:sale@connfly.com  
http://www.connfly.com  
Add:East Industry Zone  
Town Cixi Ningbo China  
P.C:315333

GENERAL TOLERANCE		ANGLE TOLERANCE	
X.	±15	X.	±3°
.X	±10	.X	±2°
.XX	±5	.XX	±1°
DRAWING TYPE	CUSTOMER		
SCALE	1:1	SHEET	1 OF 1
DRAWING NO.	C-DS1015-03-XXXXXXD		

PROJECTION	TITLE
UNITS	DS1015-03 (2*DS1015-01)
SHEET SIZE	SERIES DS1015-03 SERIES

 晨翔电子有限公司  
**CONNFLY CONNFLY ELECTRONIC CO. LTD**

REV.	DESCRIPTION	DRAWN	CHECKED	APPROVED
A	NEW RELEASE	YCH 06/12/07'	~	

N=NUMBER OF CONTACTS

1. PRODUCT NUMBER CODE:

DS1015-03 -XX R X A X - X - X

CABLE STYLE  
E: TYPE E  
LENGTH DIM L  
0150: L=150mm

WIRE DIAMETER  
1:∅0.100 FOLWER MARK  
2:∅0.127 RED MARK  
3:∅0.100 RED MARK  
4:∅0.127 FOLWER MARK

FLAT CABLE COLOR  
A: GRAY

CONTACT PLATING  
2: GOLD+NICKEL  
6: FULL TIN  
8: FULL GOLD FLASH

HOUSING COLOR  
R:RED

NO.OF CONTACTS  
04 06 08 10 12  
14 16 18 20 24

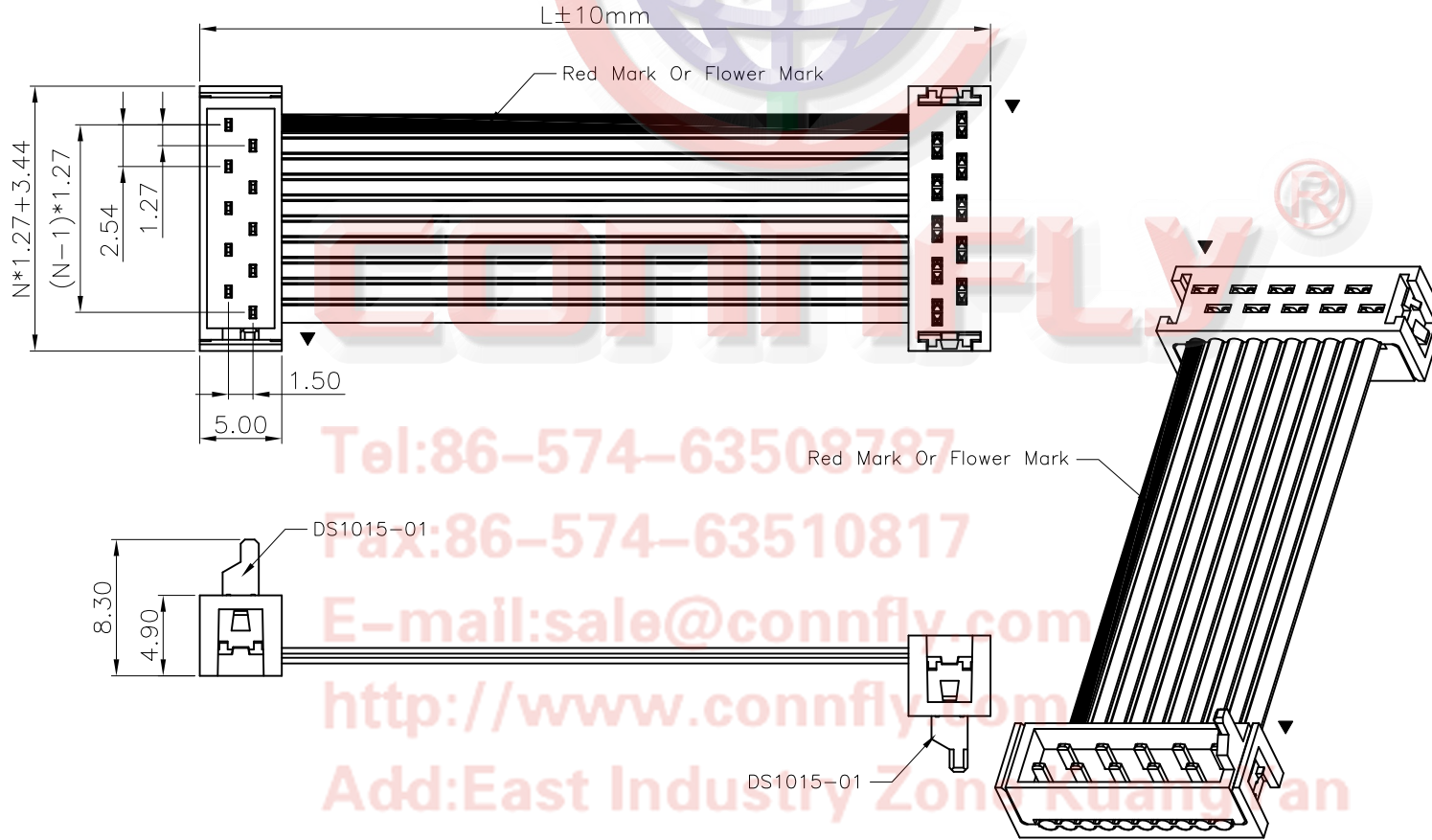

Tel:86-574-63508787  
Fax:86-574-63510817  
E-mail:sale@connfly.com  
http://www.connfly.com  
Add:East Industry Zone, Kuaifan  
Town Cixi Ningbo China  
P.C:315333

GENERAL TOLERANCE		ANGLE TOLERANCE	
X.	±15	X.	±3°
.X	±10	.X	±2°
.XX	±5	.XX	±1°

PROJECTION	TITLE
UNITS	DS1015-03 (2*DS1015-01)
SHEET SIZE	SERIES DS1015-03 SERIES

DRAWING TYPE	CUSTOMER		
SCALE	1:1	SHEET	1 OF 1
DRAWING NO.	C-DS1015-03-XXXXXXE		

 晨翔电子有限公司  
CONNFLY CONNFLY ELECTRONIC CO. LTD



REV.	DESCRIPTION	DRAWN	CHECKED	APPROVED
A	NEW RELEASE	YCH 06/12/07'	~	YCH 06/12/07'
B	更改线长代码	YCH 10/22/13'	~	

N=NUMBER OF CONTACTS

1. PRODUCT NUMBER CODE:

DS1015-03 -XX R X A X - X - X

CABLE STYLE  
F: TYPE F

LENGTH DIM L  
0150: L=150mm  
0130: L=130mm  
0120: L=120mm  
0070: L=70mm  
0060: L=60mm  
1000: L=1000mm

WIRE DIAMETER  
1:φ0.100 FOLWER MARK  
2:φ0.127 RED MARK  
3:φ0.100 RED MARK  
4:φ0.127 FOLWER MARK

FLAT CABLE COLOR  
A: GRAY

CONTACT PLATING  
2: GOLD+NICKEL  
6: FULL TIN  
8: FULL GOLD FLASH

HOUSING COLOR  
R:RED

NO.OF CONTACTS  
04 06 08 10 12  
14 16 18 20 24

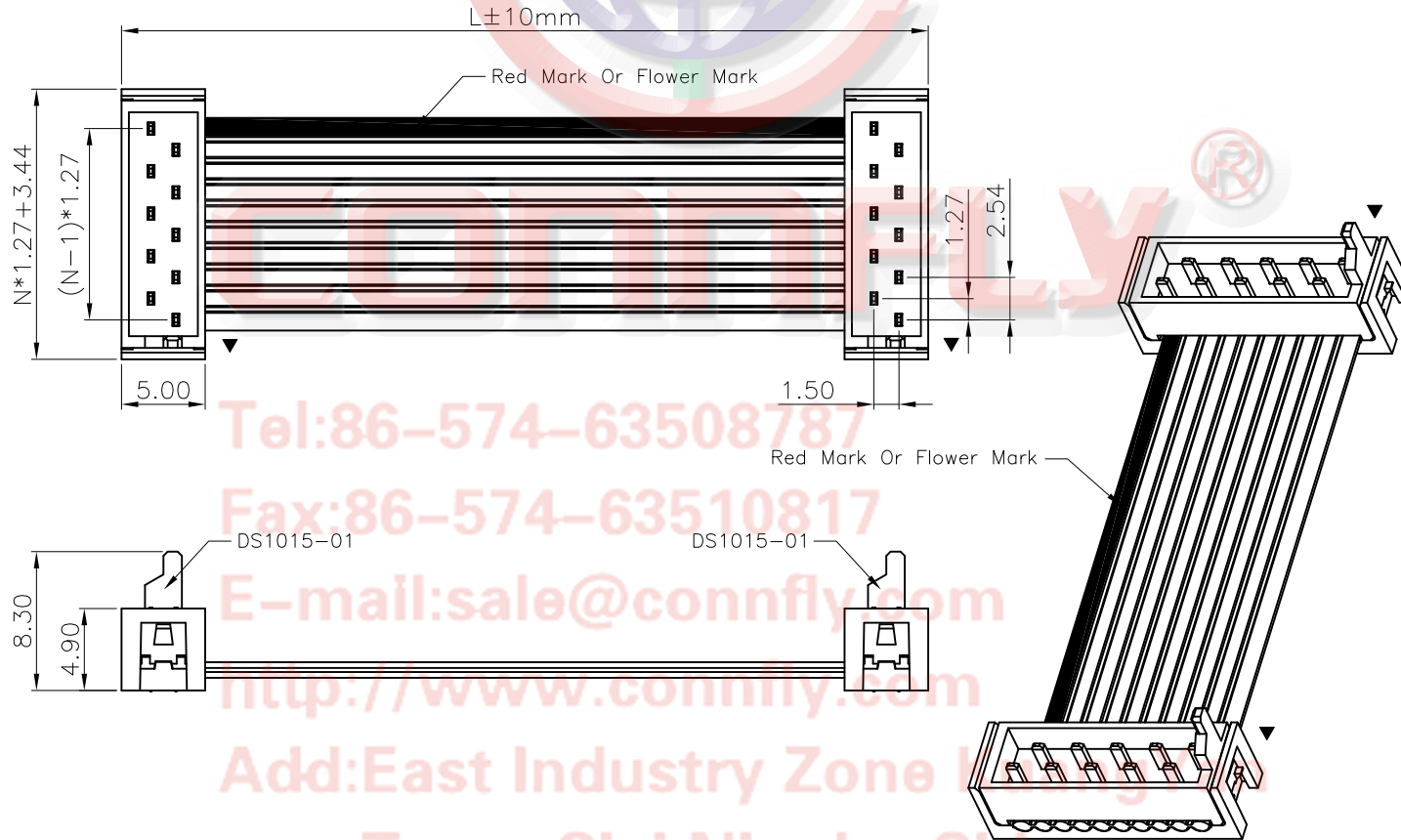

Tel:86-574-63508787  
 Fax:86-574-63510817  
 E-mail:sale@connfly.com  
 http://www.connfly.com  
 Add:East Industry Zone  
 Town Cixi Ningbo China  
 P.C:315333

GENERAL TOLERANCE		ANGLE TOLERANCE	
X.	±15	X.	±3°
.X	±10	.X	±2°
.XX	±5	.XX	±1°
DRAWING TYPE	CUSTOMER		
SCALE	1:1	SHEET	1 OF 1
DRAWING NO.	C-DS1015-03-XXXXXXF		

PROJECTION	TITLE
	DS1015-03 (2*DS1015-01)
UNITS	mm
SHEET SIZE	A4
SERIES	DS1015-03 SERIES

晨翔电子有限公司  
**CONNFLY CONNFLY ELECTRONIC CO. LTD**

REV.	DESCRIPTION	DRAWN	CHECKED	APPROVED
A	NEW RELEASE	YCH 06/12/07'	~	

N=NUMBER OF CONTACTS

1. PRODUCT NUMBER CODE:

DS1015-03 -XX R X A X - X - X

CABLE STYLE  
G: TYPE G  
LENGTH DIM L  
0150: L=150mm

WIRE DIAMETER  
1:∅0.100 FOLWER MARK  
2:∅0.127 RED MARK  
3:∅0.100 RED MARK  
4:∅0.127 FOLWER MARK

FLAT CABLE COLOR  
A: GRAY

CONTACT PLATING  
2: GOLD+NICKEL  
6: FULL TIN  
8: FULL GOLD FLASH

HOUSING COLOR  
R:RED

NO.OF CONTACTS  
04 06 08 10 12  
14 16 18 20 24

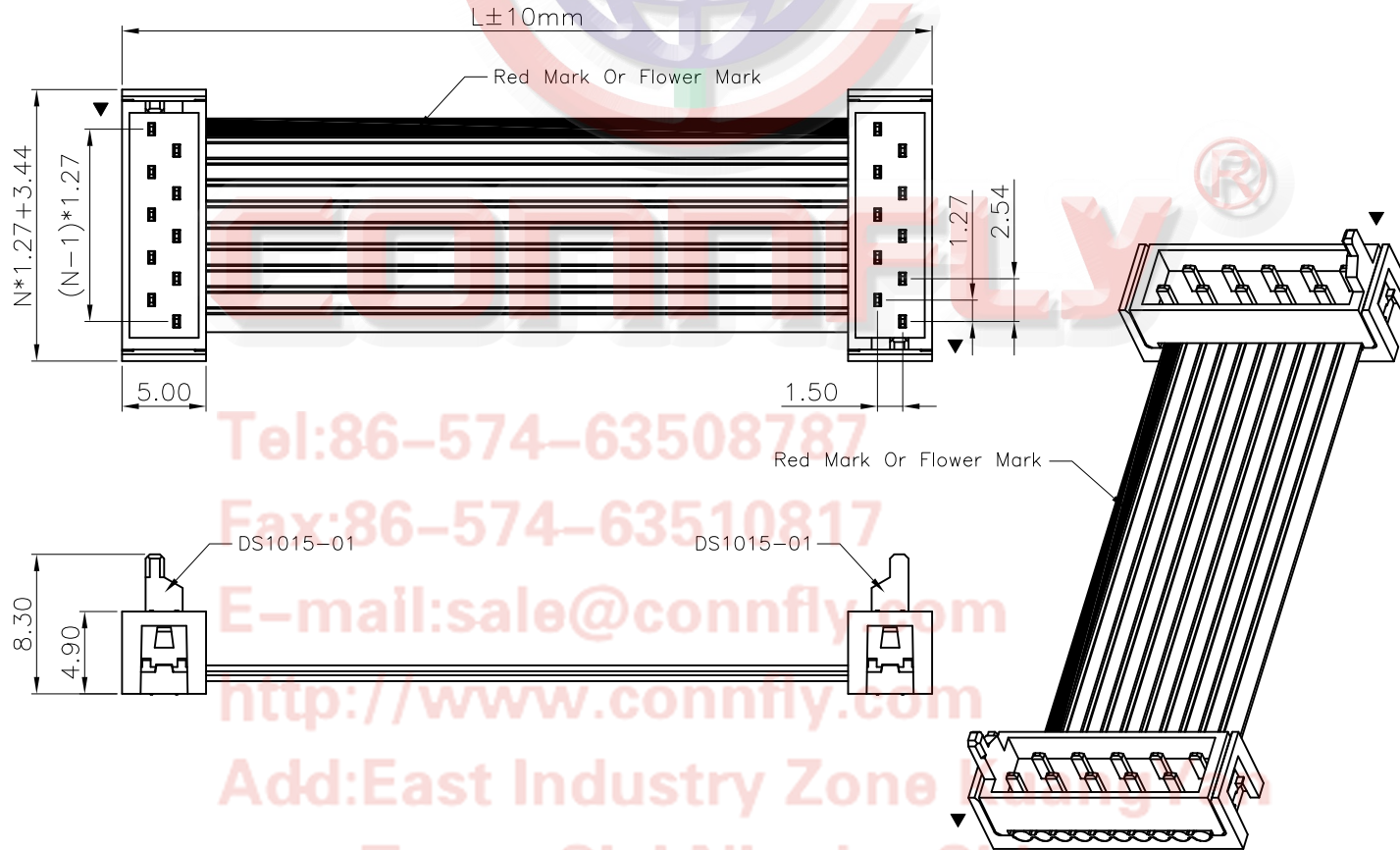

Tel:86-574-63508787  
Fax:86-574-63510817  
E-mail:sale@connfly.com  
http://www.connfly.com  
Add:East Industry Zone  
Town Cixi Ningbo China  
P.C:315333

GENERAL TOLERANCE		ANGLE TOLERANCE	
X.	±15	X.	±3°
.X	±10	.X	±2°
.XX	±5	.XX	±1°

PROJECTION	TITLE
UNITS	DS1015-03 (2*DS1015-01)
SHEET SIZE	SERIES DS1015-03 SERIES

DRAWING TYPE	CUSTOMER		
SCALE	1:1	SHEET	1 OF 1
DRAWING NO.	C-DS1015-03-XXXXXXG		

 晨翔电子有限公司  
**CONNFLY CONNFLY ELECTRONIC CO. LTD**

REV.	DESCRIPTION	DRAWN	CHECKED	APPROVED
A	NEW RELEASE	YCH 06/12/07'	~	

N=NUMBER OF CONTACTS

1. PRODUCT NUMBER CODE:

DS1015-03 -XX R X A X - X - X

CABLE STYLE  
H: TYPE H  
LENGTH DIM L  
0150: L=150mm

WIRE DIAMETER  
1:∅0.100 FOLWER MARK  
2:∅0.127 RED MARK  
3:∅0.100 RED MARK  
4:∅0.127 FOLWER MARK

FLAT CABLE COLOR  
A: GRAY

CONTACT PLATING  
2: GOLD+NICKEL  
6: FULL TIN  
8: FULL GOLD FLASH

HOUSING COLOR  
R:RED

NO.OF CONTACTS  
04 06 08 10 12  
14 16 18 20 24

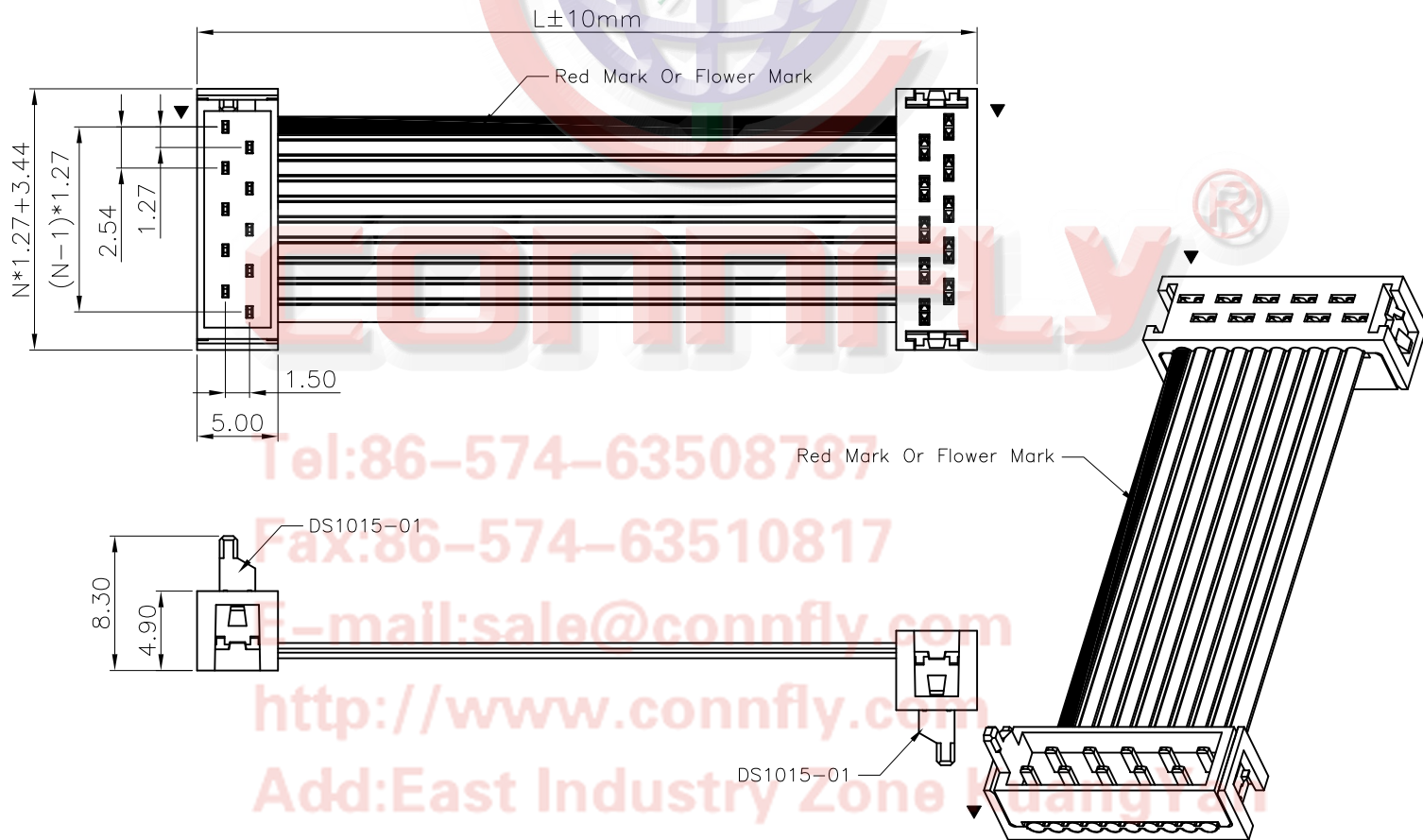

Tel:86-574-63508787  
Fax:86-574-63510817  
E-mail:sale@connfly.com  
http://www.connfly.com  
Add:East Industry Zone Huangyan  
Town Cixi Ningbo China  
P.C:315333

GENERAL TOLERANCE		ANGLE TOLERANCE	
X.	±15	X.	±3°
.X	±10	.X	±2°
.XX	±5	.XX	±1°
DRAWING TYPE	CUSTOMER		
SCALE	1:1	SHEET	1 OF 1
DRAWING NO.	C-DS1015-03-XXXXXXH		

PROJECTION	TITLE
	DS1015-03 (2*DS1015-01)
UNITS	mm
SHEET SIZE	A4
SERIES	DS1015-03 SERIES

晨翔电子有限公司  
CONNFLY CONNFLY ELECTRONIC CO. LTD



REV.	DESCRIPTION	DRAWN	CHECKED	APPROVED
A	NEW RELEASE	YCH 06/12/07'	~	

N=NUMBER OF CONTACTS

1. PRODUCT NUMBER CODE:

DS1015-03 -XX R X A X - X - X

CABLE STYLE  
J: TYPE J  
LENGTH DIM L  
0150: L=150mm

WIRE DIAMETER  
1:∅0.100 FOLWER MARK  
2:∅0.127 RED MARK  
3:∅0.100 RED MARK  
4:∅0.127 FOLWER MARK

FLAT CABLE COLOR  
A: GRAY

CONTACT PLATING  
2: GOLD+NICKEL  
6: FULL TIN  
8: FULL GOLD FLASH

HOUSING COLOR  
R:RED

NO.OF CONTACTS  
04 06 08 10 12  
14 16 18 20 24

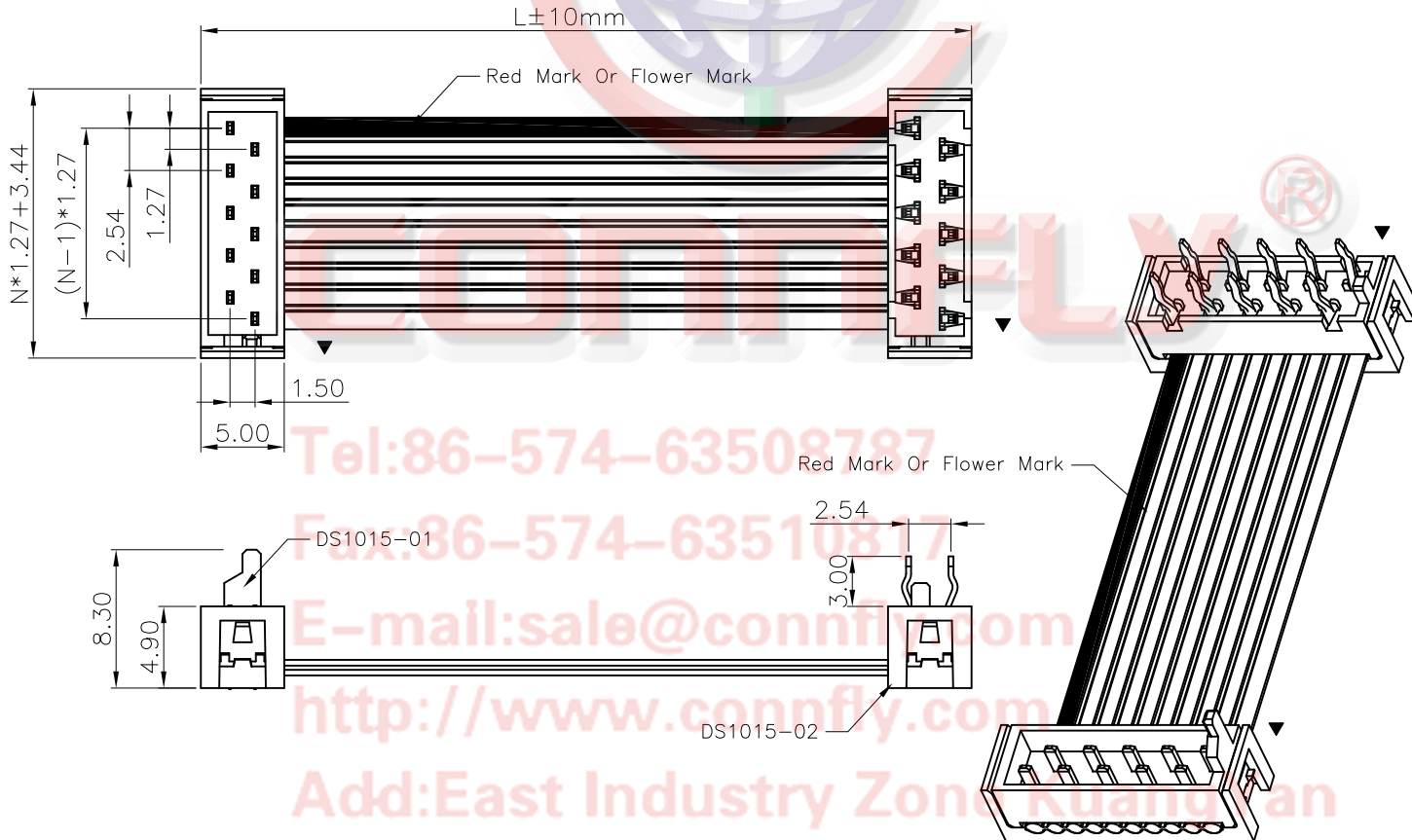

Tel:86-574-63508787  
Fax:86-574-63510817  
E-mail:sale@connfly.com  
http://www.connfly.com  
Add:East Industry Zone, Kuantan  
Town Cixi Ningbo China  
P.C:315333

GENERAL TOLERANCE		ANGLE TOLERANCE	
X.	±15	X.	±3°
.X	±10	.X	±2°
.XX	±5	.XX	±1°
DRAWING TYPE	CUSTOMER		
SCALE	1:1	SHEET	1 OF 1
DRAWING NO.	C-DS1015-03-XXXXXXJ		

PROJECTION	TITLE
UNITS	DS1015-03 (1*DS1015-01&1*DS1015-02)
SHEET SIZE	SERIES DS1015-03 SERIES

 晨翔电子有限公司  
**CONNFLY CONNFLY ELECTRONIC CO. LTD**

REV.	DESCRIPTION	DRAWN	CHECKED	APPROVED
A	NEW RELEASE	YCH 06/12/07'	~	

N=NUMBER OF CONTACTS

1. PRODUCT NUMBER CODE:

DS1015-03 -XX R X A X - X - X

CABLE STYLE  
K: TYPE K  
LENGTH DIM L  
0150: L=150mm

WIRE DIAMETER  
1:∅0.100 FOLWER MARK  
2:∅0.127 RED MARK  
3:∅0.100 RED MARK  
4:∅0.127 FOLWER MARK

FLAT CABLE COLOR  
A: GRAY

CONTACT PLATING  
2: GOLD+NICKEL  
6: FULL TIN  
8: FULL GOLD FLASH

HOUSING COLOR  
R:RED

NO.OF CONTACTS  
04 06 08 10 12  
14 16 18 20 24

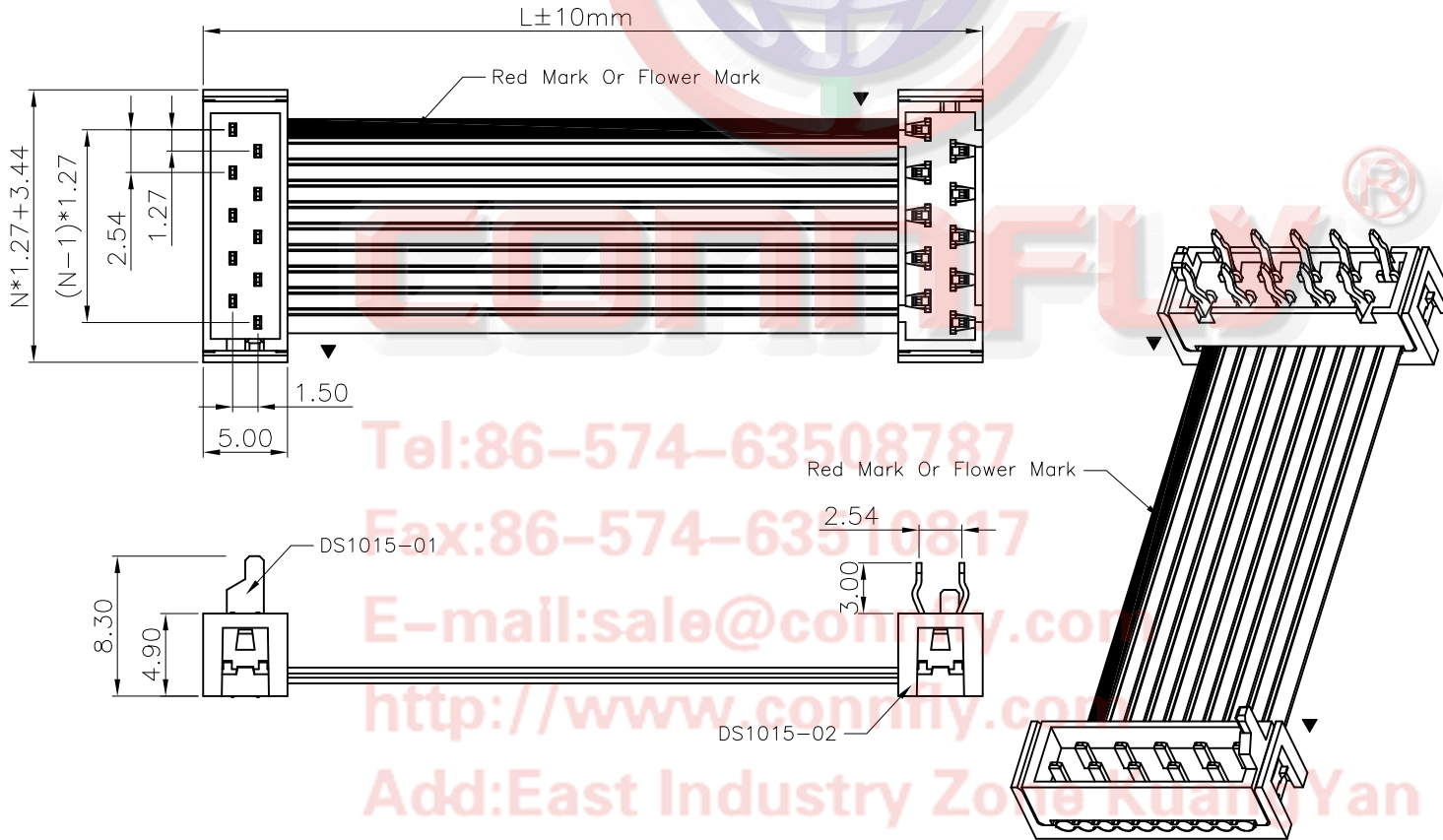

Tel:86-574-63508787

Fax:86-574-63510817

E-mail:sale@connfly.com

http://www.connfly.com

Add:East Industry Zone Kuanqian Yan

Town Cixi Ningbo China

P.C:315333

GENERAL TOLERANCE		ANGLE TOLERANCE	
X.	±15	X.	±3°
.X	±10	.X	±2°
.XX	±5	.XX	±1°

PROJECTION	TITLE
UNITS	DS1015-03 (1*DS1015-01&1*DS1015-02)
SHEET SIZE	SERIES DS1015-03 SERIES

DRAWING TYPE	CUSTOMER
SCALE	1:1 SHEET 1 OF 1
DRAWING NO.	C-DS1015-03-XXXXXXX

 晨翔电子有限公司  
CONNFLY CONNFLY ELECTRONIC CO. LTD

REV.	DESCRIPTION	DRAWN	CHECKED	APPROVED
A	NEW RELEASE	YCH 06/12/07'	~	

N=NUMBER OF CONTACTS

1. PRODUCT NUMBER CODE:

DS1015-03 -XX R X A X - X - X

CABLE STYLE  
M: TYPE M  
LENGTH DIM L  
0150: L=150mm

WIRE DIAMETER  
1:∅0.100 FOLWER MARK  
2:∅0.127 RED MARK  
3:∅0.100 RED MARK  
4:∅0.127 FOLWER MARK

FLAT CABLE COLOR  
A: GRAY

CONTACT PLATING  
2: GOLD+NICKEL  
6: FULL TIN  
8: FULL GOLD FLASH

HOUSING COLOR  
R:RED

NO.OF CONTACTS  
04 06 08 10 12  
14 16 18 20 24

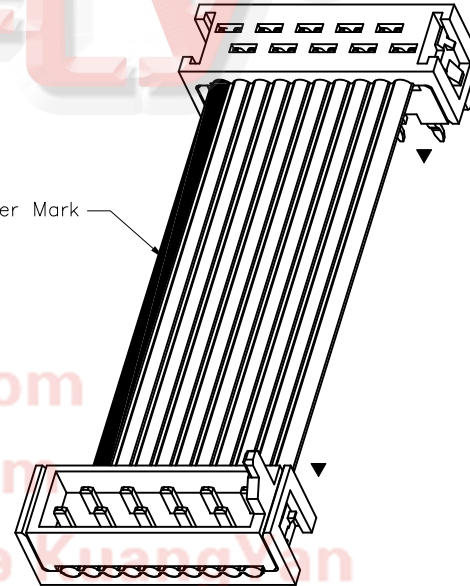
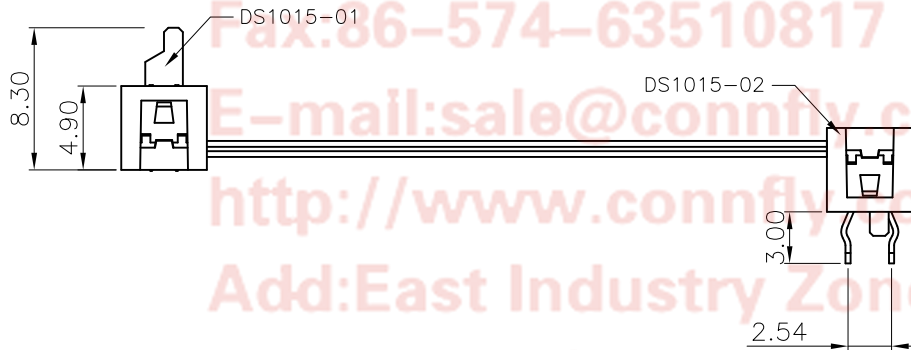
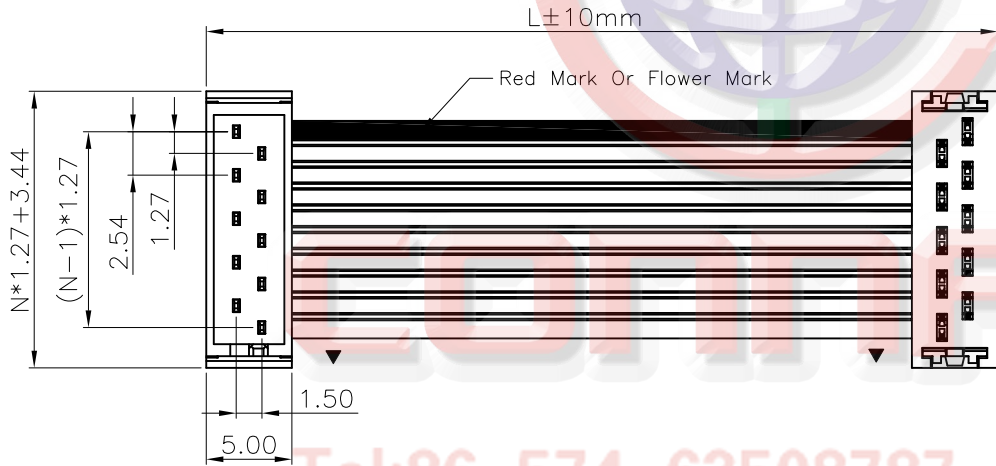

Tel:86-574-63508787

Fax:86-574-63510817

E-mail:sale@connfly.com

http://www.connfly.com

Add:East Industry Zone Guangyan

Town Cixi Ningbo China

P.C:315333

GENERAL TOLERANCE		ANGLE TOLERANCE	
X.	±15	X.	±3°
.X	±10	.X	±2°
.XX	±5	.XX	±1°

PROJECTION	TITLE
UNITS	DS1015-03 (1*DS1015-01&1*DS1015-02)
SHEET SIZE	SERIES DS1015-03 SERIES

DRAWING TYPE	CUSTOMER
SCALE	1:1 SHEET 1 OF 1
DRAWING NO.	C-DS1015-03-XXXXXXM

 晨翔电子有限公司  
CONNFLY CONNFLY ELECTRONIC CO. LTD

REV.	DESCRIPTION	DRAWN	CHECKED	APPROVED
A	NEW RELEASE	YCH 06/12/07'	~	

N=NUMBER OF CONTACTS

1. PRODUCT NUMBER CODE:

DS1015-03 -XX R X A X - X - X

CABLE STYLE  
N: TYPE N

LENGTH DIM L  
0150: L=150mm

WIRE DIAMETER  
1:∅0.100 FOLWER MARK  
2:∅0.127 RED MARK  
3:∅0.100 RED MARK  
4:∅0.127 FOLWER MARK

FLAT CABLE COLOR  
A: GRAY

CONTACT PLATING  
2: GOLD+NICKEL  
6: FULL TIN  
8: FULL GOLD FLASH

HOUSING COLOR  
R:RED

NO.OF CONTACTS  
04 06 08 10 12  
14 16 18 20 24

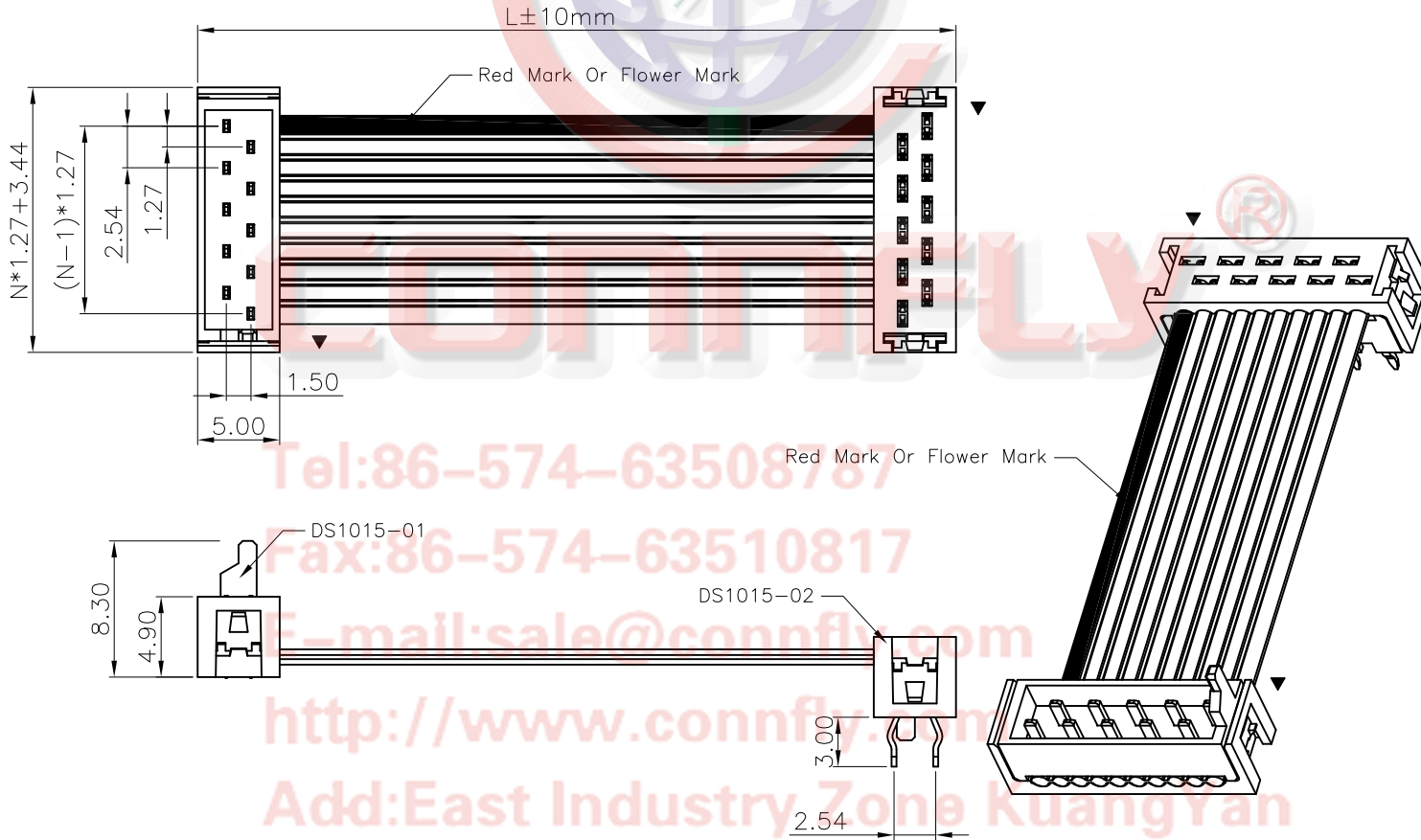

Tel:86-574-63508787  
Fax:86-574-63510817  
E-mail:sale@connfly.com  
http://www.connfly.com  
Add:East Industry Zone KuangYan  
Town Cixi Ningbo China  
P.C:315333

GENERAL TOLERANCE		ANGLE TOLERANCE	
X.	±15	X.	±3°
.X	±10	.X	±2°
.XX	±5	.XX	±1°
DRAWING TYPE	CUSTOMER		
SCALE	1:1	SHEET	1 OF 1
DRAWING NO.	C-DS1015-03-XXXXXXN		

PROJECTION	TITLE
UNITS	DS1015-03 (1*DS1015-01&1*DS1015-02)
SHEET SIZE	SERIES DS1015-03 SERIES

 晨翔电子有限公司  
**CONNFLY CONNFLY ELECTRONIC CO. LTD**

REV.	DESCRIPTION	DRAWN	CHECKED	APPROVED
A	NEW RELEASE	YCH 06/12/07'	~	

N=NUMBER OF CONTACTS

1. PRODUCT NUMBER CODE:

DS1015-03 -XX R X A X - X - X

CABLE STYLE  
P: TYPE P

LENGTH DIM L  
0150: L=150mm

WIRE DIAMETER  
1:∅0.100 FOLWER MARK  
2:∅0.127 RED MARK  
3:∅0.100 RED MARK  
4:∅0.127 FOLWER MARK

FLAT CABLE COLOR  
A: GRAY

CONTACT PLATING  
2: GOLD+NICKEL  
6: FULL TIN  
8: FULL GOLD FLASH

HOUSING COLOR  
R:RED

NO.OF CONTACTS  
04 06 08 10 12  
14 16 18 20 24

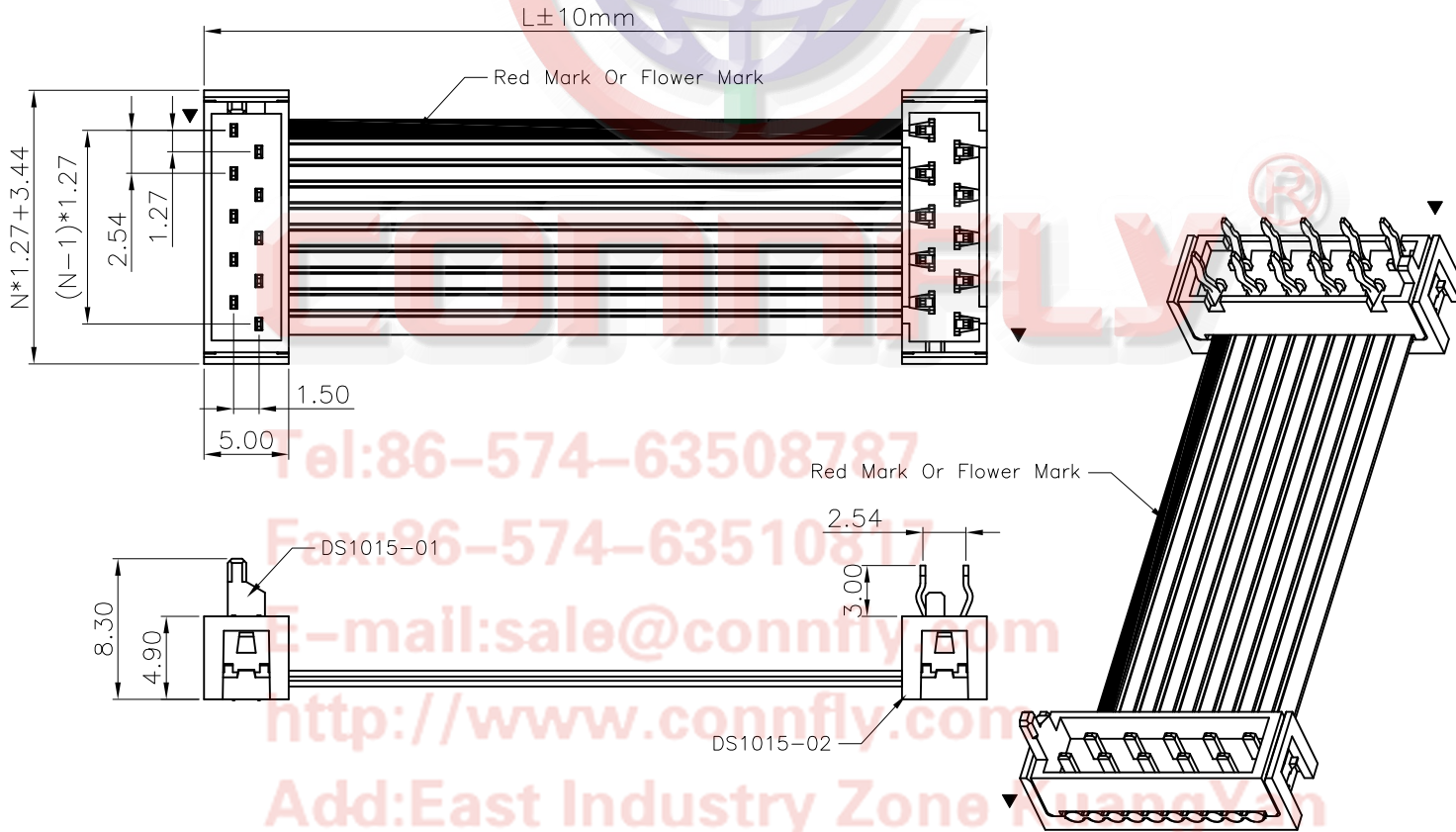

Tel:86-574-63508787

Fax:86-574-63510817

E-mail:sale@connfly.com

http://www.connfly.com

Add:East Industry Zone

Town Cixi Ningbo China

P.C:315333

GENERAL TOLERANCE		ANGLE TOLERANCE	
X.	±15	X.	±3°
.X	±10	.X	±2°
.XX	±5	.XX	±1°

PROJECTION	TITLE
UNITS	DS1015-03 (1*DS1015-01&1*DS1015-02)
SHEET SIZE	SERIES DS1015-03 SERIES

DRAWING TYPE	CUSTOMER		
SCALE	1:1	SHEET	1 OF 1
DRAWING NO.	C-DS1015-03-XXXXXXP		

 晨翔电子有限公司  
**CONNFLY CONNFLY ELECTRONIC CO. LTD**



REV.	DESCRIPTION	DRAWN	CHECKED	APPROVED
A	NEW RELEASE	YCH 06/12/07'	~	

N=NUMBER OF CONTACTS

1. PRODUCT NUMBER CODE:

DS1015-03 -XX R X A X - X - X

CABLE STYLE  
Q: TYPE Q  
LENGTH DIM L  
0150: L=150mm

WIRE DIAMETER  
1:∅0.100 FOLWER MARK  
2:∅0.127 RED MARK  
3:∅0.100 RED MARK  
4:∅0.127 FOLWER MARK

FLAT CABLE COLOR  
A: GRAY

CONTACT PLATING  
2: GOLD+NICKEL  
6: FULL TIN  
8: FULL GOLD FLASH

HOUSING COLOR  
R:RED

NO.OF CONTACTS  
04 06 08 10 12  
14 16 18 20 24

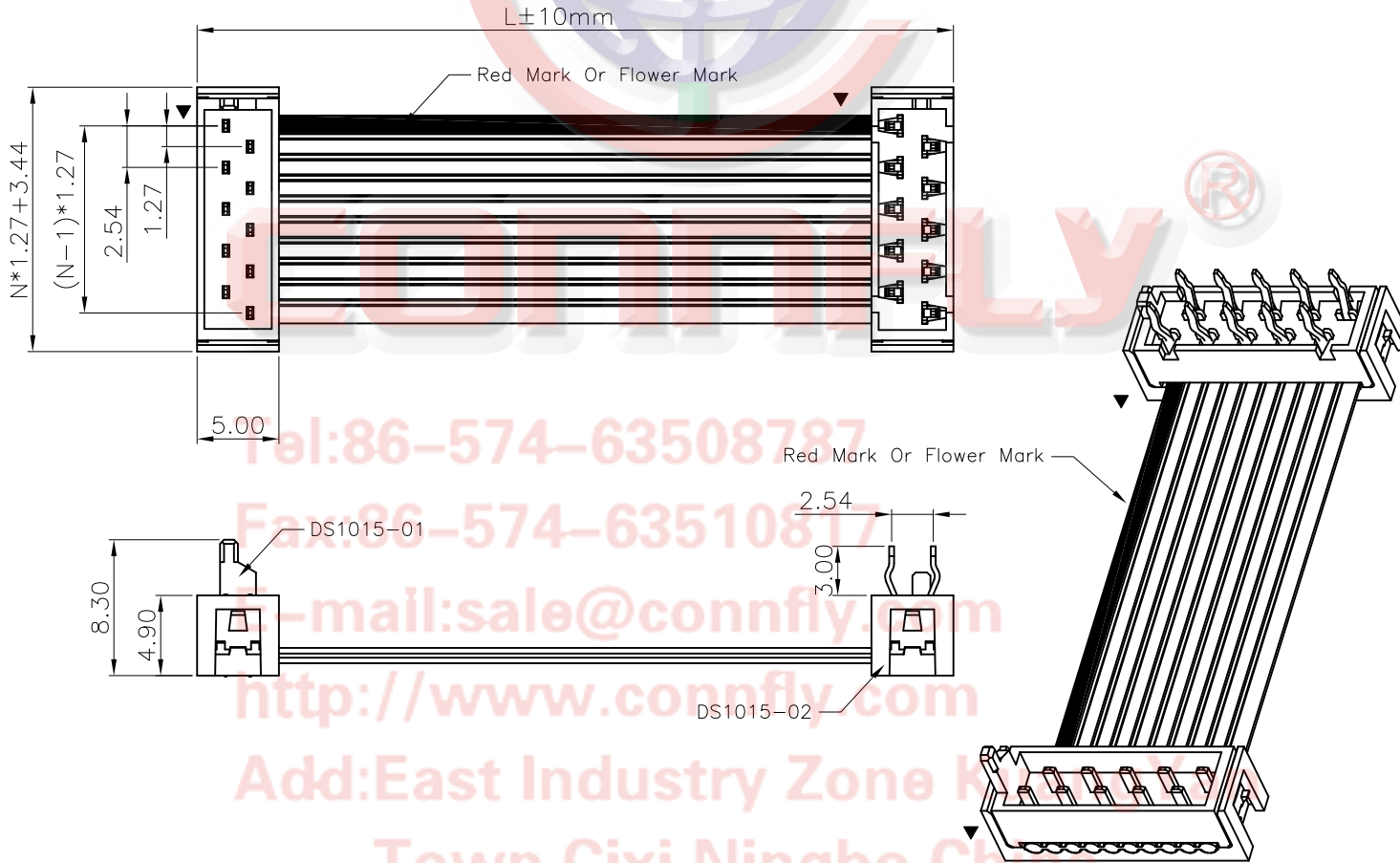

Tel:86-574-63508787  
Fax:86-574-63510817  
E-mail:sale@connfly.com  
http://www.connfly.com  
Add:East Industry Zone K  
Town Cixi Ningbo China  
P.C:315333

GENERAL TOLERANCE		ANGLE TOLERANCE	
X.	±15	X.	±3°
.X	±10	.X	±2°
.XX	±5	.XX	±1°

PROJECTION	TITLE
UNITS	DS1015-03 (1*DS1015-01&1*DS1015-02)
SHEET SIZE	SERIES DS1015-03 SERIES

DRAWING TYPE	CUSTOMER
SCALE	1:1 SHEET 1 OF 1
DRAWING NO.	C-DS1015-03-XXXXXXQ

 晨翔电子有限公司  
**CONNFLY CONNFLY ELECTRONIC CO. LTD**

REV.	DESCRIPTION	DRAWN	CHECKED	APPROVED
A	NEW RELEASE	YCH 06/12/07'	~	

N=NUMBER OF CONTACTS

1. PRODUCT NUMBER CODE:

DS1015-03 -XX R X A X - X - X

CABLE STYLE  
R: TYPE R  
LENGTH DIM L  
0150: L=150mm

WIRE DIAMETER  
1:∅0.100 FOLWER MARK  
2:∅0.127 RED MARK  
3:∅0.100 RED MARK  
4:∅0.127 FOLWER MARK

FLAT CABLE COLOR  
A: GRAY

CONTACT PLATING  
2: GOLD+NICKEL  
6: FULL TIN  
8: FULL GOLD FLASH

HOUSING COLOR  
R:RED

NO.OF CONTACTS  
04 06 08 10 12  
14 16 18 20 24

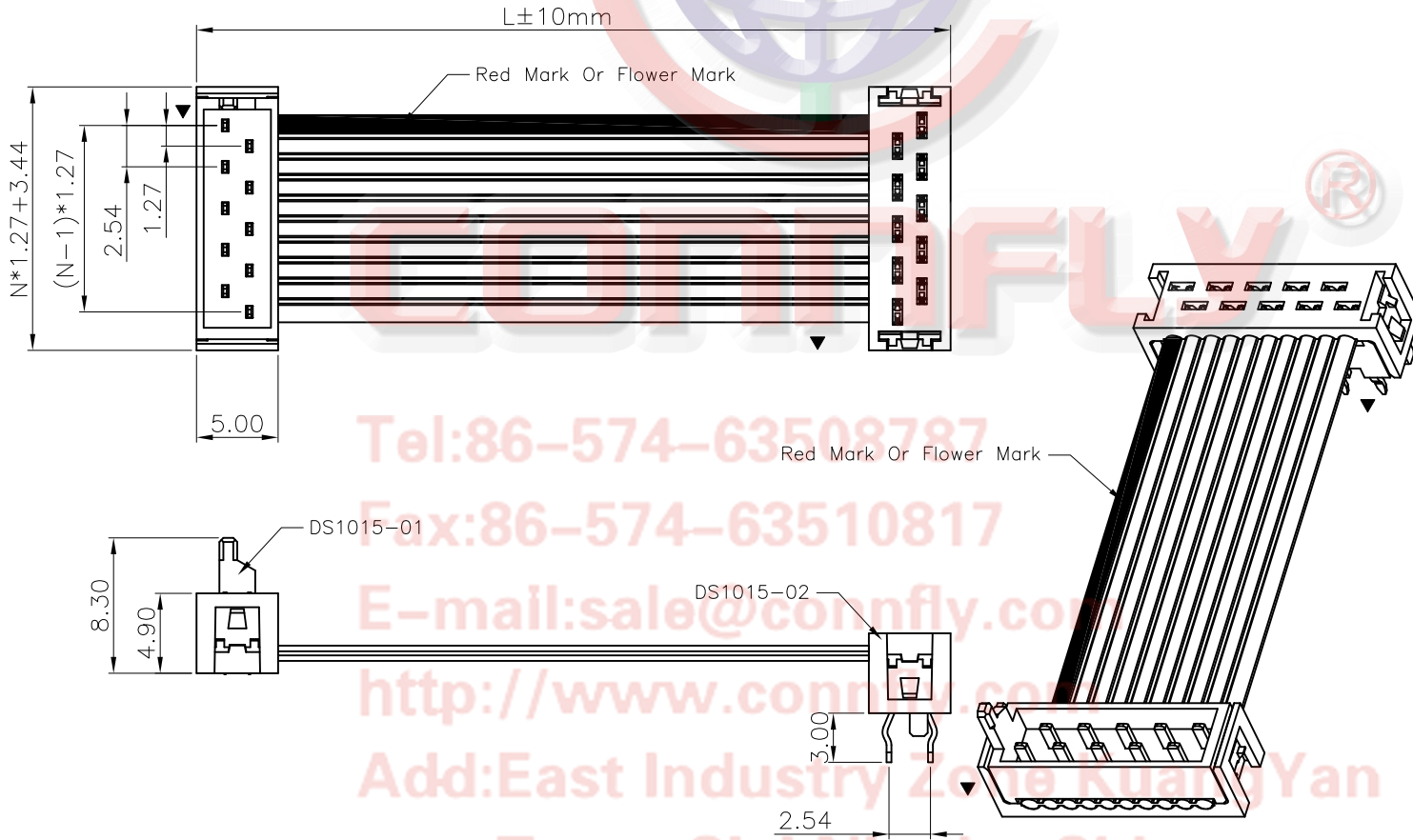

Tel:86-574-63508787

Fax:86-574-63510817

E-mail:sale@connfly.com

http://www.connfly.com

Add:East Industry Zone Nuan Yan

Town Cixi Ningbo China

P.C:315333

GENERAL TOLERANCE		ANGLE TOLERANCE	
X.	±15	X.	±3°
.X	±10	.X	±2°
.XX	±5	.XX	±1°

PROJECTION	TITLE
UNITS	DS1015-03 (1*DS1015-01&1*DS1015-02)
SHEET SIZE	SERIES DS1015-03 SERIES

DRAWING TYPE	CUSTOMER
SCALE	1:1 SHEET 1 OF 1
DRAWING NO.	C-DS1015-03-XXXXXXR

 晨翔电子有限公司  
**CONNFLY CONNFLY ELECTRONIC CO. LTD**

REV.	DESCRIPTION	DRAWN	CHECKED	APPROVED
A	NEW RELEASE	YCH 06/12/07'	~	

N=NUMBER OF CONTACTS

1. PRODUCT NUMBER CODE:

DS1015-03 -XX R X A X - X - X

CABLE STYLE  
S: TYPE S

LENGTH DIM L  
0150: L=150mm

WIRE DIAMETER  
1:∅0.100 FOLWER MARK  
2:∅0.127 RED MARK  
3:∅0.100 RED MARK  
4:∅0.127 FOLWER MARK

FLAT CABLE COLOR  
A: GRAY

CONTACT PLATING  
2: GOLD+NICKEL  
6: FULL TIN  
8: FULL GOLD FLASH

HOUSING COLOR  
R:RED

NO.OF CONTACTS  
04 06 08 10 12  
14 16 18 20 24

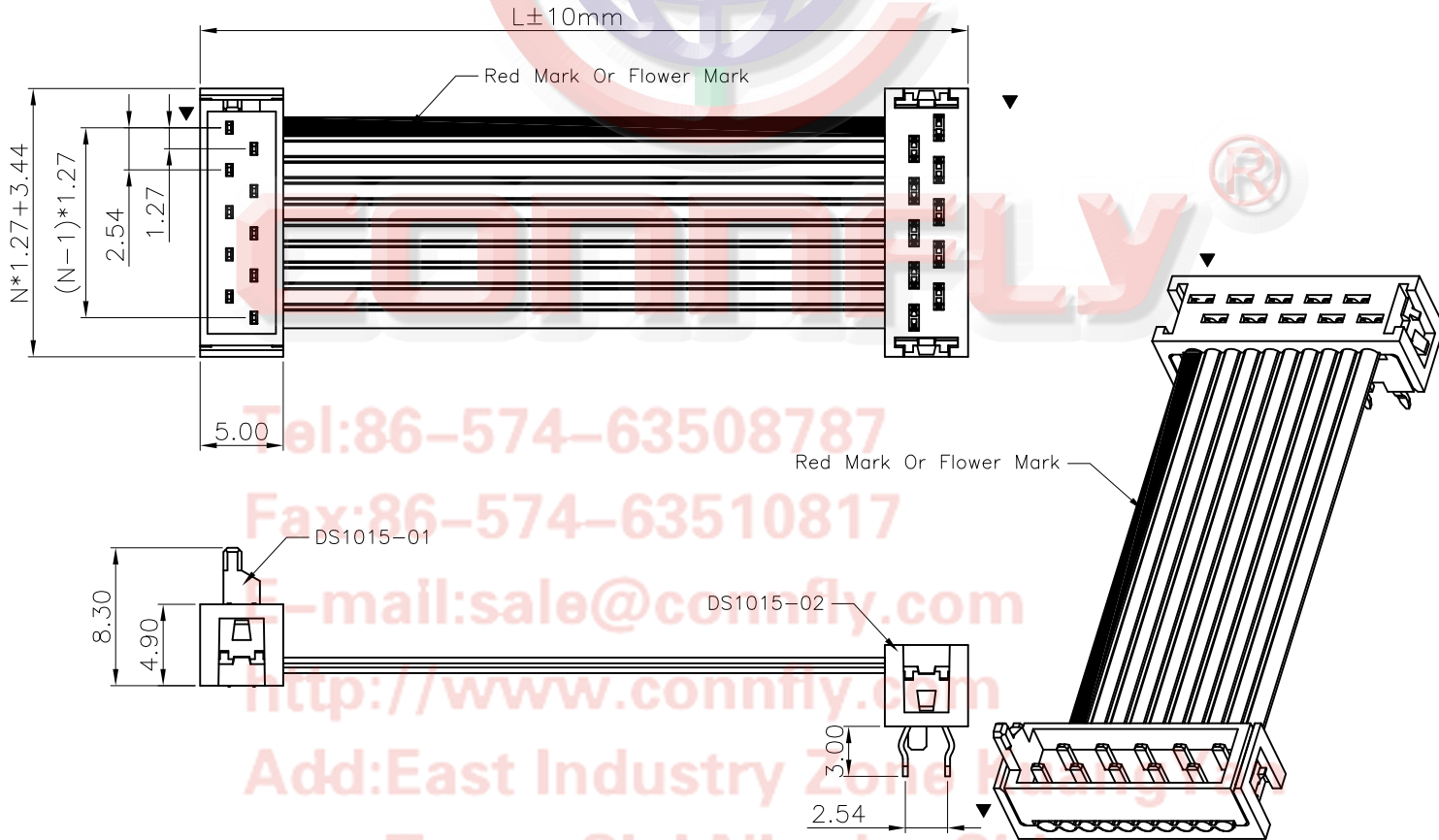

Tel:86-574-63508787  
Fax:86-574-63510817  
E-mail:sale@connfly.com  
http://www.connfly.com  
Add:East Industry Zone  
Town Cixi Ningbo China  
P.C:315333

GENERAL TOLERANCE		ANGLE TOLERANCE	
X.	±15	X.	±3°
.X	±10	.X	±2°
.XX	±5	.XX	±1°
DRAWING TYPE	CUSTOMER		
SCALE	1:1	SHEET	1 OF 1
DRAWING NO.	C-DS1015-03-XXXXXXS		

PROJECTION	TITLE
	DS1015-03 (1*DS1015-01&1*DS1015-02)
UNITS	mm
SHEET SIZE	A4
SERIES	DS1015-03 SERIES

晨翔电子有限公司  
CONNFLY CONNFLY ELECTRONIC CO. LTD

REV.	DESCRIPTION	DRAWN	CHECKED	APPROVED
A	NEW RELEASE	YCH 06/12/07'	~	

N=NUMBER OF CONTACTS

1. PRODUCT NUMBER CODE:

DS1015-03 -XX R X A X - X - X

CABLE STYLE  
T: TYPE T  
LENGTH DIM L  
04200210:L=420mm/L1=210mm

WIRE DIAMETER  
1:∅0.100 FOLWER MARK  
2:∅0.127 RED MARK  
3:∅0.100 RED MARK  
4:∅0.127 FOLWER MARK

FLAT CABLE COLOR  
A: GRAY

CONTACT PLATING  
2: GOLD+NICKEL  
6: FULL TIN  
8: FULL GOLD FLASH

HOUSING COLOR  
R:RED

NO.OF CONTACTS  
04 06 08 10 12  
14 16 18 20 24

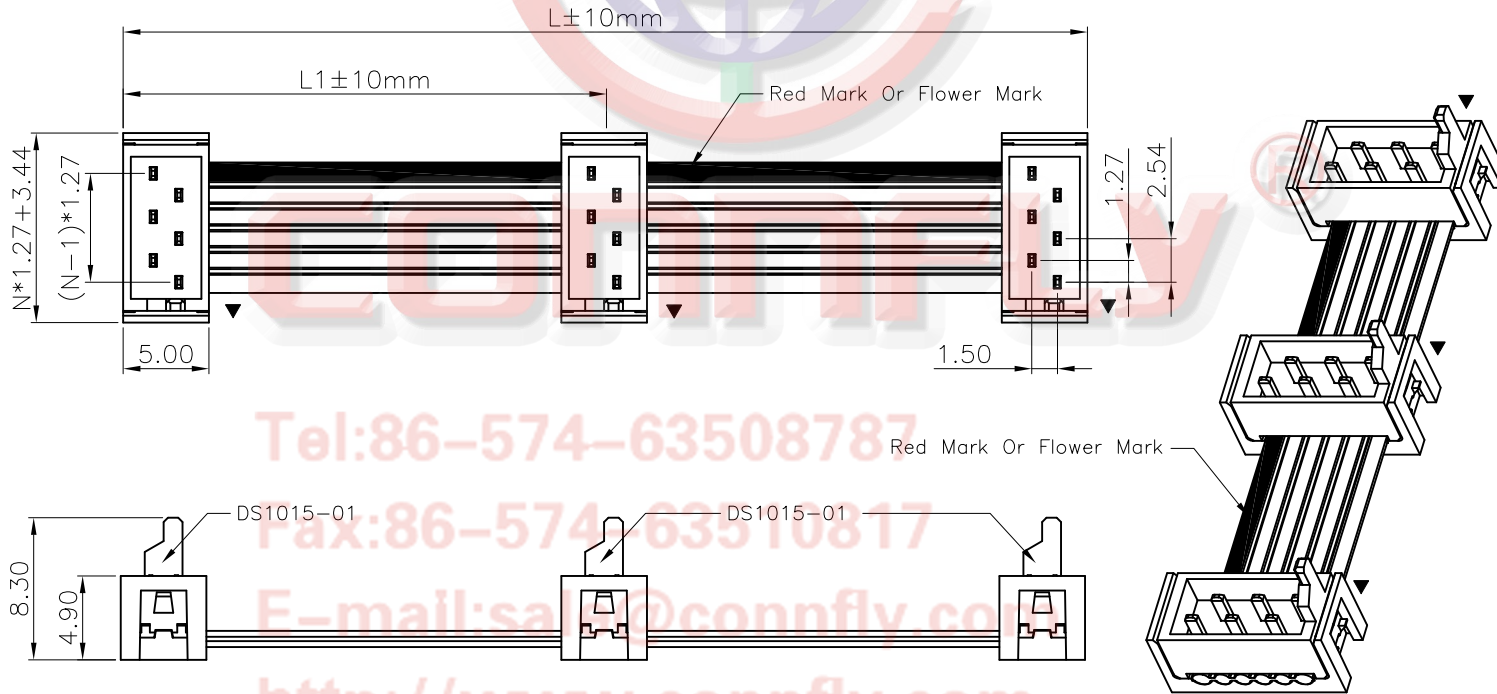

Tel:86-574-63508787

Fax:86-574-63510817

E-mail:sales@connfly.com

http://www.connfly.com

Add:East Industry Zone KuangYan

Town Cixi Ningbo China

P.C:315333

GENERAL TOLERANCE		ANGLE TOLERANCE	
X.	±15	X.	±3°
.X	±10	.X	±2°
.XX	±5	.XX	±1°

PROJECTION	TITLE
UNITS	DS1015-03 (3*DS1015-01)
SHEET SIZE	SERIES DS1015-03 SERIES

DRAWING TYPE	CUSTOMER		
SCALE	1:1	SHEET	1 OF 1
DRAWING NO.	C-DS1015-03-XXXXXXT		

 晨翔电子有限公司  
CONNFLY CONNFLY ELECTRONIC CO. LTD