



PA4990

CMOS IC

1.2W AUDIO POWER AMPLIFIER WITH ACTIVE-LOW SHUTDOWN MODE

DESCRIPTION

As a power amplifier which is operating on a single 5V supply, the UTC **PA4990** is capable of delivering 1.2W of output power into 8Ω loads with less than 1% distortion.

The UTC **PA4990** is optimally suited for applications: Mobile phones (cellular/cordless), notebook computers PDAs and Portable audio devices.

The shutdown mode can reduce the supply current to less than 10nA. It also includes thermal shutdown protection internally. By external gain setting resistors the gain can be configured.

FEATURES

- * Operating: $V_{CC}=2.2V \sim 5.5V$
- * 1.2W output power, $V_{CC}=5V$, THD=1%, $f=1kHz$, 8Ω Load
- * In shutdown mode: Ultra-low consumption (10nA)
- * In grounded mode: 62dB PSRR @ 217Hz
- * POP & CLICK near-zero
- * Ultra-low distortion :0.1% (typ)

ORDERING INFORMATION

Ordering Number			Package	Packing
Normal	Lead Free	Halogen Free		
PA4990-S08-R	PA4990L-S08-R	PA4990G-S08-R	SOP-8	Tape Reel
PA4990-SM1-R	PA4990L-SM1-R	PA4990G-SM1-R	MSOP-8	Tape Reel

<p>PA4900L-S08-R</p> <p>(1)Packing Type</p> <p>(2)Package Type</p> <p>(3)Lead Plating</p>	<p>(1) R: Tape Reel</p> <p>(2) S08: SOP-8, SM1: MSOP-8</p> <p>(3) G: Halogen Free, L: Lead Free, Blank: Pb/Sn</p>
---	---

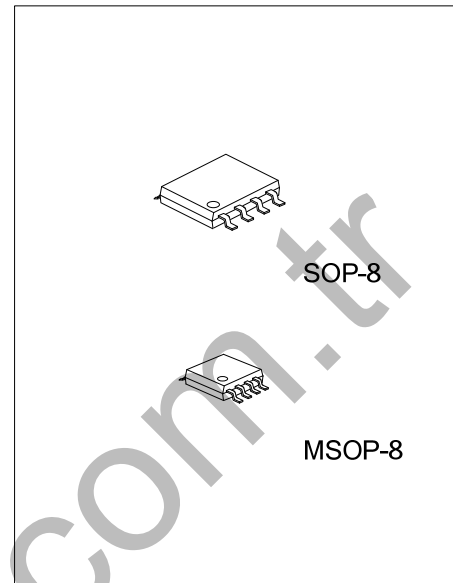

Lead-free: PA4990L
Halogen-free:PA4990G

■ PIN CONFIGURATION

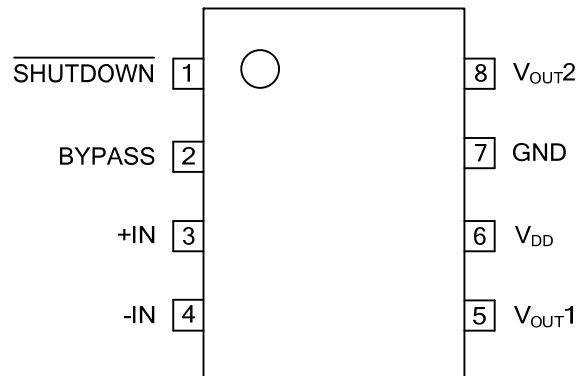

■ PIN DESCRIPTION

PIN NO	PIN NAME	DESCRIPTION
1	SHUTDOWN	Shutdown control input pin.
2	BYPASS	Connected to a bypass capacitor.
3	+IN	+ pin of input signal.
4	-IN	- pin of input signal.
5	V _{OUT1}	Output pin1
6	V _{DD}	Supply voltage
7	GND	GND
8	V _{OUT2}	Output pin2

■ ABSOLUTE MAXIMUM RATING

PARAMETER	SYMBOL	RATINGS	UNIT
Supply Voltage	V_{DD}	6	V
Input Voltage	V_{IN}	GND ~ V_{DD}	V
Power Dissipation	P_D	Internally Limited	W
Junction Temperature	T_J	150	°C
Operating Temperature	T_{OPR}	-40~+85	°C
Storage Temperature	T_{STG}	-65~+150	°C

Note: Absolute maximum ratings are those values beyond which the device could be permanently damaged.
Absolute maximum ratings are stress ratings only and functional device operation is not implied.

■ THERMAL DATA

PARAMETER	SYMBOL	MIN	TYP	MAX	UNIT
Junction to Ambient	θ_{JA}			150	°C/W
Junction to Case	θ_{JC}			35	°C/W

■ ELECTRICAL CHARACTERISTICS ($T_A=25^\circ\text{C}$, GND=0V, $R_L=8\Omega$, unless otherwise specified)

$V_{DD}=2.6\text{V}$

PARAMETER	SYMBOL	TEST CONDITIONS	MIN	TYP	MAX	UNIT
Supply Voltage	V_{DD}		2.2		5.5	V
Output Offset Voltage	V_{OS}	No input signal		1	10	mV
Shutdown Voltage	V_{ST}				1.2	V
					0.4	
Supply Current	I_{DD}	No input signal, no load		3.1	6	mA
Shutdown Current ¹	$I_{SHUTDOWN}$	No input signal, $V_{STDBY}=GND$		10	1000	nA
Output Power	P_{OUT}	THD=1% Max, $f_{IN}=1\text{kHz}$	220	300		mW
Total Harmonic Distortion+Noise	THD+N	$P_{OUT}=200\text{mW}_{RMS}$, $A_v=2$, $20\text{Hz} \leq f \leq 20\text{kHz}$		0.1		%
Power Supply Rejection Ratio	PSRR	$A_v=2$, $V_{RIPPLE}=200\text{mVpp}$, Input Grounded	$f=217\text{Hz}$	55	60	dB
			$f=1\text{kHz}$	55	62	
Wake-Up Time	T_{WU}	$C_b=1\mu\text{F}$, no load		125	150	ms
Shutdown Time	T_{STDB}	$C_b=1\mu\text{F}$, no load		10		μs

$V_{DD}=3.3\text{V}$

PARAMETER	SYMBOL	TEST CONDITIONS	MIN	TYP	MAX	UNIT
Supply Voltage	V_{DD}		2.2		5.5	V
Output Offset Voltage	V_{OS}	No input signal		1	10	mV
Shutdown Voltage	V_{ST}				1.2	V
					0.4	
Supply Current	I_{DD}	No input signal, no load		3.3	6	mA
Shutdown Current	$I_{SHUTDOWN}$	No input signal, $V_{STDBY}=GND$		10	1000	nA
Output Power	P_{OUT}	THD=1% Max, $f_{IN}=1\text{kHz}$	375	500		mW
Total Harmonic Distortion+Noise	THD+N	$P_{OUT}=400\text{mW}_{RMS}$, $A_v=2$, $20\text{Hz} \leq f \leq 20\text{kHz}$,		0.1		%
Power Supply Rejection Ratio	PSRR	$A_v=2$, $V_{RIPPLE} = 200\text{mVpp}$, Input Grounded	$f=217\text{Hz}$	55	61	dB
			$f=1\text{kHz}$	55	63	
Wake-Up Time	T_{WU}	$C_b=1\mu\text{F}$, no load		110	140	ms
Shutdown Time	T_{STDB}	$C_b=1\mu\text{F}$, no load		10		μs

■ ELECTRICAL CHARACTERISTICS(Cont.)

V_{DD}=5V

PARAMETER	SYMBOL	TEST CONDITIONS	MIN	TYP	MAX	UNIT
Supply Voltage	V _{DD}		2.2		5.5	V
Output Offset Voltage	V _{OS}	No input signal		1	10	mV
Shutdown Voltage	High				1.3	V
	Low				0.4	
Supply Current	I _{DD}	No input signal, no load		3.7	6	mA
Shutdown Current	I _{SHUTDOWN}	No input signal, V _{STDBY} =GND		10	1000	nA
Output Power	P _{OUT}	THD=1% Max, f _{IN} =1kHz	0.9	1.2		W
Total Harmonic Distortion+Noise	THD+N	P _{OUT} =1W _{RMS} , Av=2, 20Hz ≤ f ≤20kHz,		0.2		%
Power Supply Rejection Ratio	PSRR	Av=2, V _{RIPPLE} =200mV _{PP} , Input Grounded	f=217Hz	55	62	dB
			f=1kHz	55	64	
Wake-Up Time	T _{WU}	Cb=1μF, no load		90	130	ms
Shutdown Time	T _{STDB}	Cb=1μF, no load		10		μs

■ BLOCK DIAGRAM

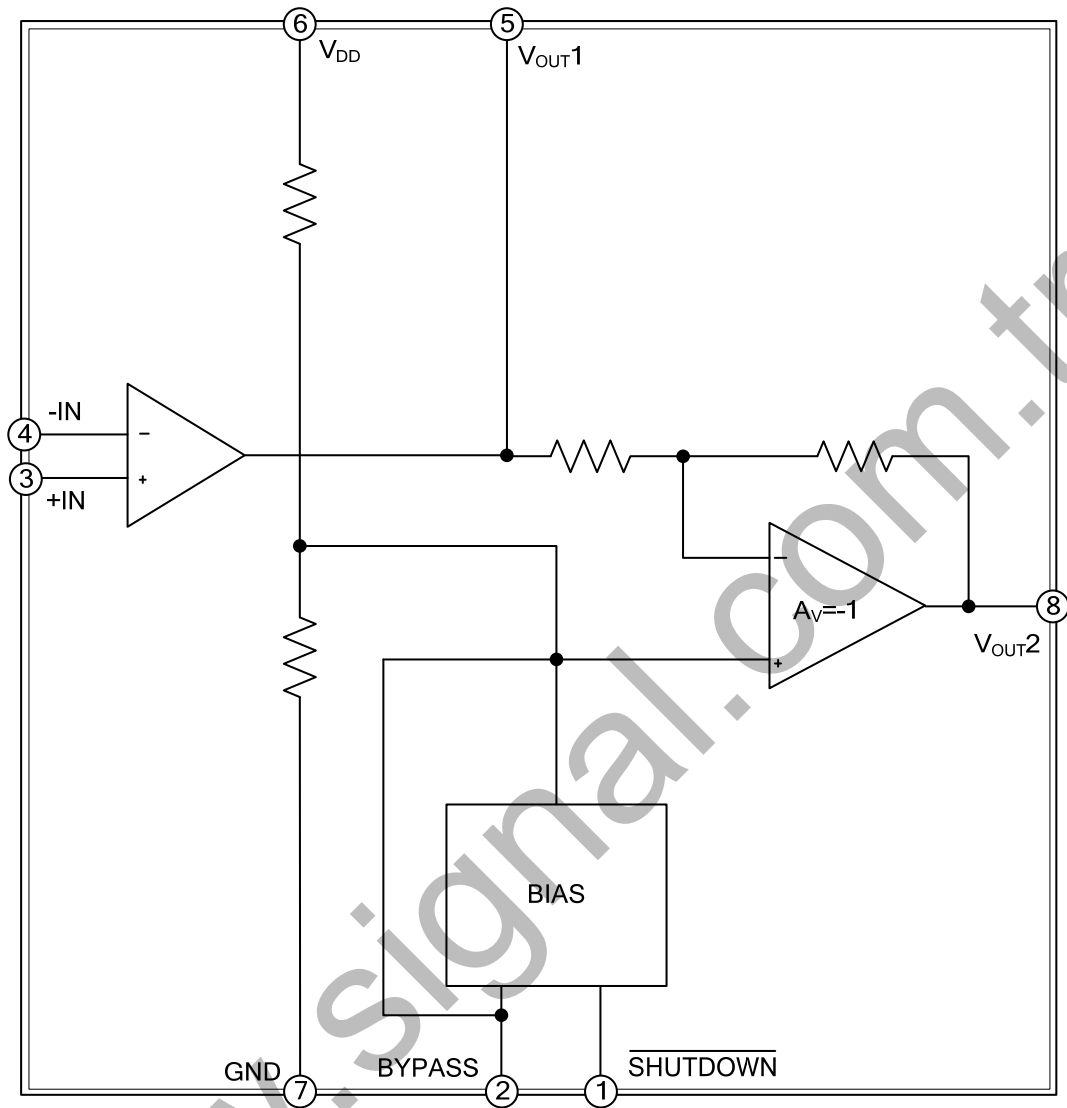

■ TYPICAL APPLICATION CIRCUIT

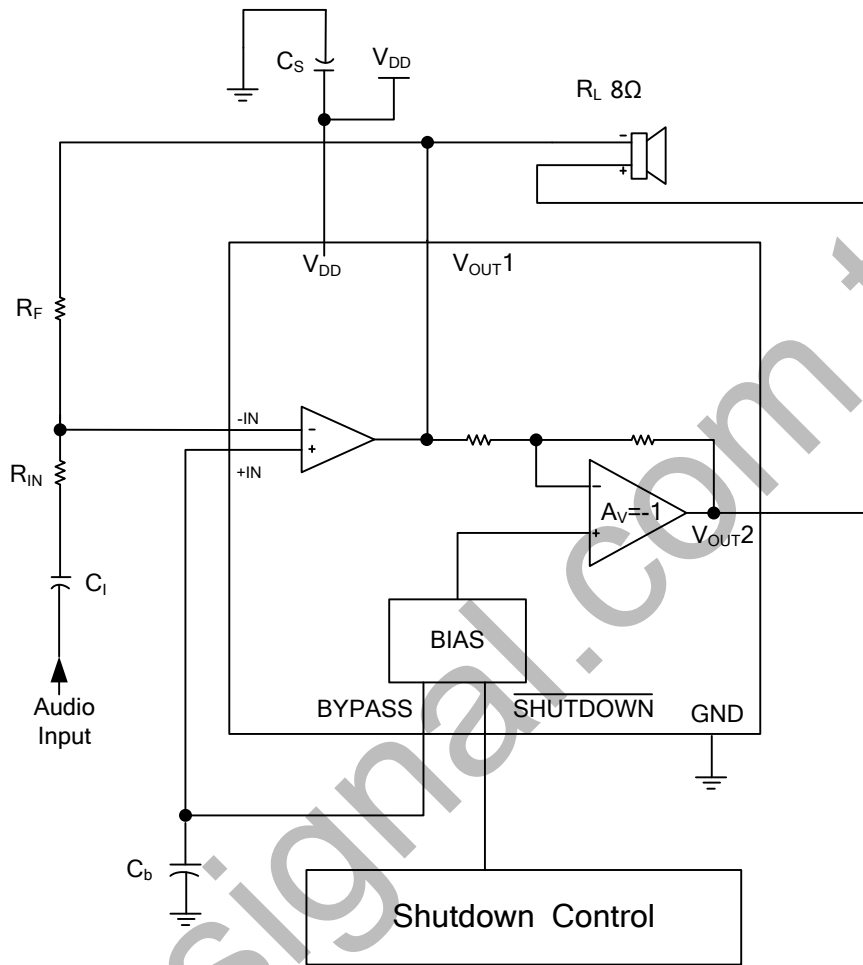

■ TYPICAL CHARACTERISTICS

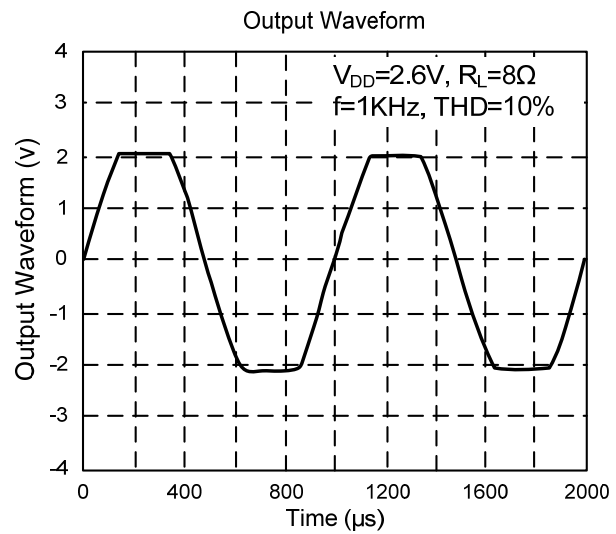
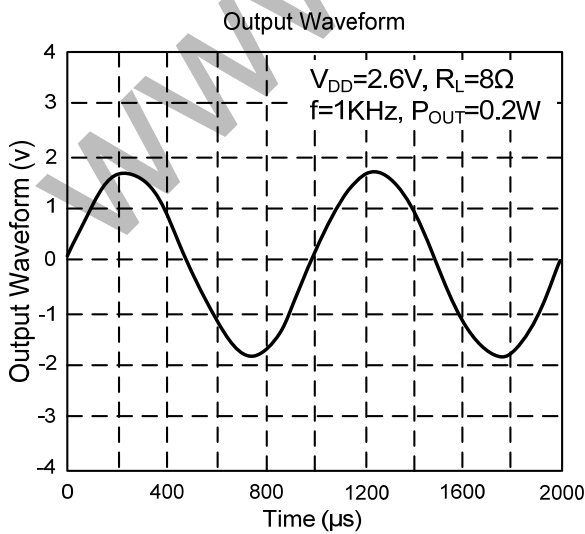
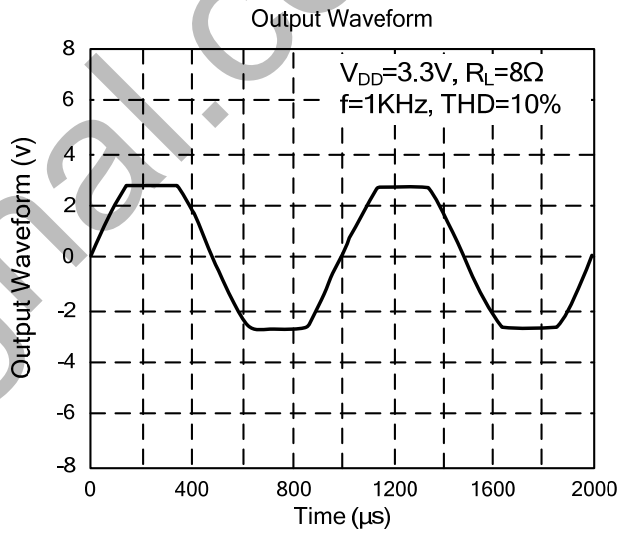
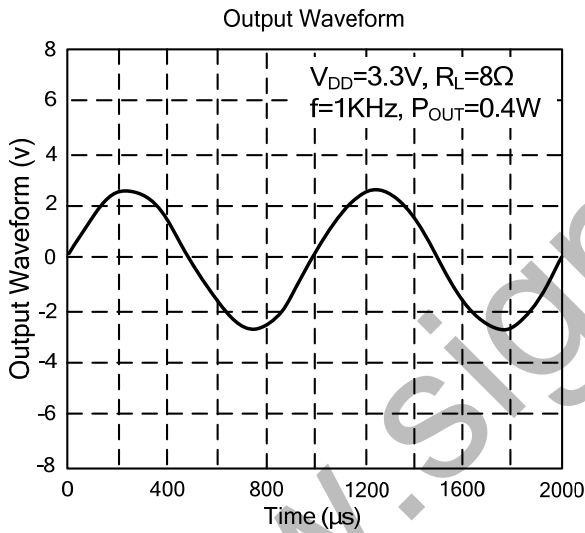
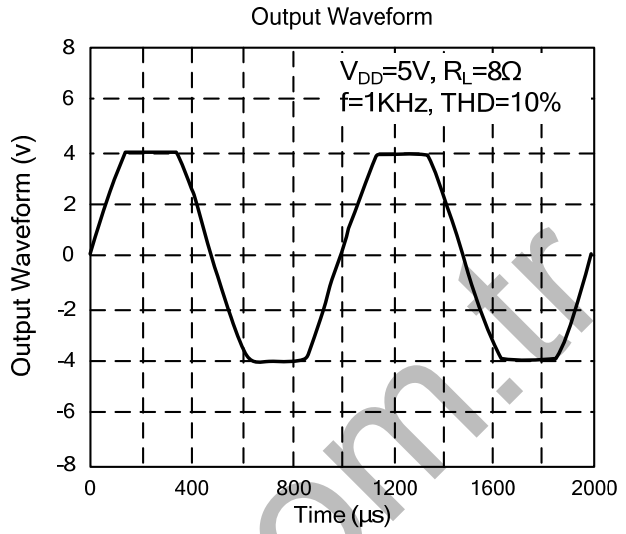
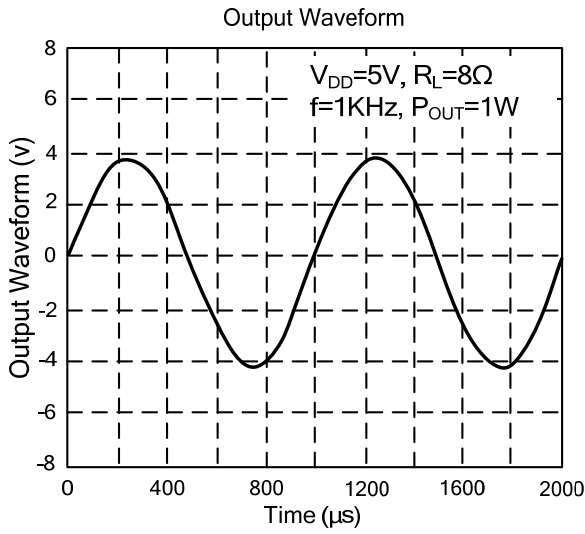

www.signal.com.tr

UTC assumes no responsibility for equipment failures that result from using products at values that exceed, even momentarily, rated values (such as maximum ratings, operating condition ranges, or other parameters) listed in products specifications of any and all UTC products described or contained herein. UTC products are not designed for use in life support appliances, devices or systems where malfunction of these products can be reasonably expected to result in personal injury. Reproduction in whole or in part is prohibited without the prior written consent of the copyright owner. The information presented in this document does not form part of any quotation or contract, is believed to be accurate and reliable and may be changed without notice.