

Old P/N.:1250 Series

## 1.25mm Terminal / Housing / Wafer SMT Straight / SMT R/A Type

### Specifications

Current Rating: 1A AC,DC  
 Voltage Rating: 125V AC,DC  
 Temperature Range: -25°C to +85°C  
 Contact Resistance: 20mΩ Max  
 Insulation Resistance: 100MΩ Min  
 Withstanding Voltage: 500V AC/minute  
 Terminal: Phosphor Bronze / Tin Plated  
 Solder Tabs: Phosphor Bronze / Tin Plated  
 Material: Housing: P.B.T, UL94V-0  
 Wafer: Nylon 6T, UL94V-0

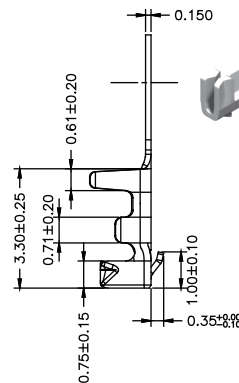
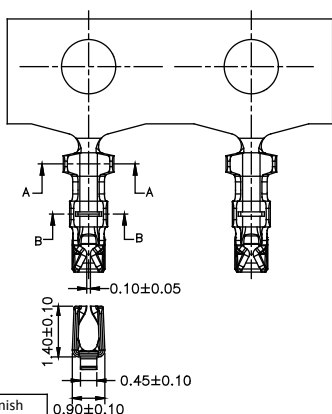
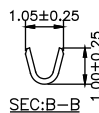
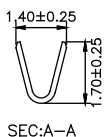

P/N.:5T1250N-PXR-01

T0: Tin plated  
G0: Gold plated

Part No.	Wire Range	Insulation O.D.	Material	Finish
5T1250N-PT0	#28-#32	1.00mm(Max)	Phosphor Bronze	Tin Plated
5T1250N-PG0	#28-#32	1.00mm(Max)	Phosphor Bronze	Gold Plated

No. of Contacts	Dimensions		No. of Contacts	Dimensions	
	A	B		A	B
2	1.25	4.25	11	12.50	15.50
3	2.50	5.50	12	13.75	16.75
4	3.75	6.75	13	15.00	18.00
5	5.00	8.00	14	16.25	19.25
6	6.25	9.25	15	17.50	20.50
7	7.50	10.50	16	18.75	21.75
8	8.75	11.75	17	20.00	23.00
9	10.00	13.00	18	21.25	24.25
10	11.25	14.25			

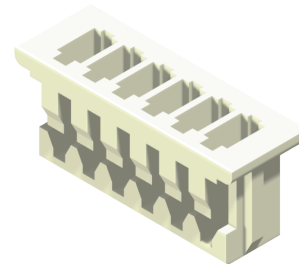
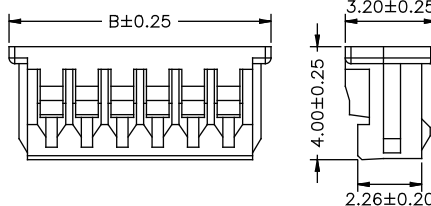
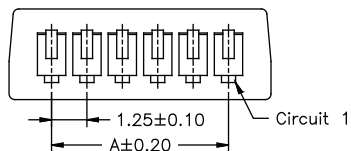

P/N.:5H1250N0-1XXWBL00-01

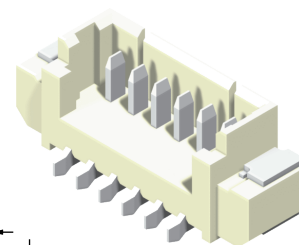
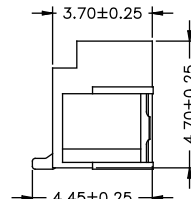
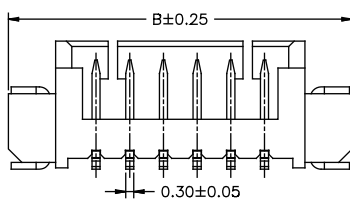
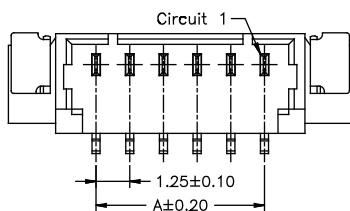
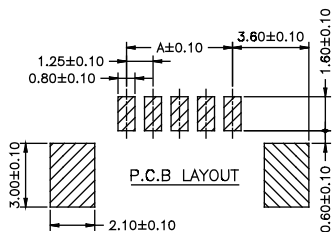

P/N.:5W1250G0-1XXT0WRU-01

No. of Contacts	Dimensions	
	A	B
2	1.25	7.75
3	2.50	9.00
4	3.75	10.25
5	5.00	11.50
6	6.25	12.75
7	7.50	14.00
8	8.75	15.25
9	10.00	16.50
10	11.25	17.75
11	12.50	19.00
12	13.75	20.25
13	15.00	21.50
14	16.25	22.75
15	17.50	24.00
16	18.75	25.25
17	20.00	26.50
18	21.25	27.75

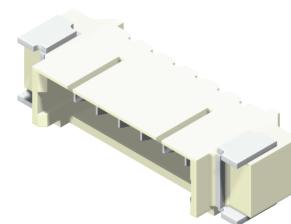
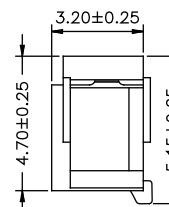
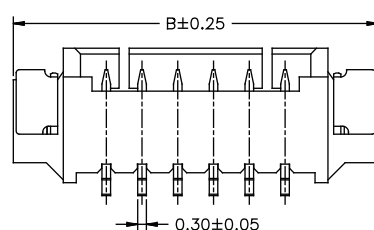
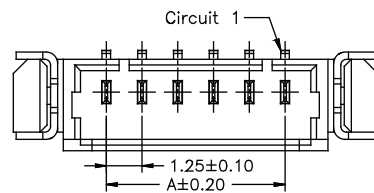
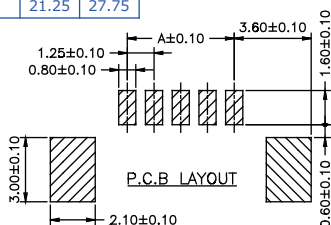

P/N.:5W1250H0-1XXT0WRU-01