

## LM50 and LM50-Q1 SOT-23 Single-Supply Centigrade Temperature Sensor

### 1 Features

- LM50-Q1 is AEC-Q100 Grade 1 Qualified and is Manufactured on an Automotive Grade Flow
- Calibrated Directly in Degrees Celsius (Centigrade)
- Linear + 10 mV/°C Scale Factor
- $\pm 2^\circ\text{C}$  Accuracy Specified at  $25^\circ\text{C}$
- Specified for Full  $-40^\circ$  to  $125^\circ\text{C}$  Range
- Suitable for Remote Applications
- Low Cost Due to Wafer-Level Trimming
- Operates From 4.5 V to 10 V
- Less Than 130- $\mu\text{A}$  Current Drain
- Low Self-Heating: Less Than  $0.2^\circ\text{C}$  in Still A
- Nonlinearity Less Than  $0.8^\circ\text{C}$  Over Temp
- UL Recognized Component

### 2 Applications

- Automotive
- Computers
- Disk Drives
- Battery Management
- FAX Machines
- Printers
- Portable Medical Instruments
- HVAC
- Power Supply Modules

### 3 Description

The LM50 and LM50-Q1 devices are precision integrated-circuit temperature sensors that can sense a  $-40^\circ\text{C}$  to  $125^\circ\text{C}$  temperature range using a single positive supply. The output voltage of the device is linearly proportional to temperature ( $10\text{ mV}/^\circ\text{C}$ ) and has a DC offset of 500 mV. The offset allows reading negative temperatures without the need for a negative supply.

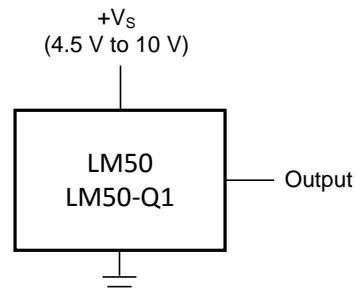
The ideal output voltage of the LM50 or LM50-Q1 ranges from 100 mV to 1.75 V for a  $-40^\circ\text{C}$  to  $125^\circ\text{C}$  temperature range. The LM50 and LM50-Q1 do not require any external calibration or trimming to provide accuracies of  $\pm 3^\circ\text{C}$  at room temperature and  $\pm 4^\circ\text{C}$  over the full  $-40^\circ\text{C}$  to  $125^\circ\text{C}$  temperature range. Trimming and calibration of the LM50 and LM50-Q1 at the wafer level assure low cost and high accuracy. The linear output, 500 mV offset, and factory calibration of the LM50 and LM50-Q1 simplify the circuitry requirements in a single supply environment where reading negative temperatures is necessary. Because the quiescent current of the LM50 and LM50-Q1 is less than 130  $\mu\text{A}$ , self-heating is limited to a very low  $0.2^\circ\text{C}$  in still air.

#### Device Information<sup>(1)</sup>

PART NUMBER	PACKAGE	BODY SIZE (NOM)
LM50, LM50-Q1	SOT-23 (3)	2.92 mm x 1.30 mm

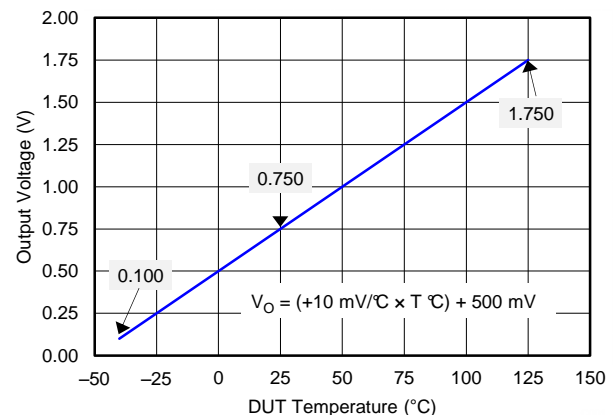
(1) For all available packages, see the orderable addendum at the end of the data sheet.

#### Simplified Schematic



Copyright © 2016, Texas Instruments Incorporated

#### Full-Range Centigrade Temperature Sensor ( $-40^\circ\text{C}$ to $125^\circ\text{C}$ )



## Table of Contents

<b>1 Features</b> .....	<b>1</b>	<b>8 Application and Implementation</b> .....	<b>9</b>
<b>2 Applications</b> .....	<b>1</b>	8.1 Application Information.....	9
<b>3 Description</b> .....	<b>1</b>	8.2 Typical Application .....	9
<b>4 Revision History</b> .....	<b>2</b>	8.3 System Examples .....	11
<b>5 Pin Configuration and Functions</b> .....	<b>3</b>	<b>9 Power Supply Recommendations</b> .....	<b>12</b>
<b>6 Specifications</b> .....	<b>3</b>	<b>10 Layout</b> .....	<b>12</b>
6.1 Absolute Maximum Ratings .....	3	10.1 Layout Guidelines .....	12
6.2 ESD Ratings.....	3	10.2 Layout Example .....	12
6.3 Recommended Operating Conditions.....	4	10.3 Thermal Considerations .....	13
6.4 Thermal Information .....	4	<b>11 Device and Documentation Support</b> .....	<b>14</b>
6.5 Electrical Characteristics: LM50B .....	4	11.1 Related Links .....	14
6.6 Electrical Characteristics: LM50C and LM50-Q1 .....	5	11.2 Receiving Notification of Documentation Updates .....	14
6.7 Typical Characteristics .....	6	11.3 Community Resources.....	14
<b>7 Detailed Description</b> .....	<b>8</b>	11.4 Trademarks .....	14
7.1 Overview .....	8	11.5 Electrostatic Discharge Caution.....	14
7.2 Functional Block Diagram .....	8	11.6 Glossary .....	14
7.3 Feature Description.....	8	<b>12 Mechanical, Packaging, and Orderable Information</b> .....	<b>14</b>
7.4 Device Functional Modes.....	8		

## 4 Revision History

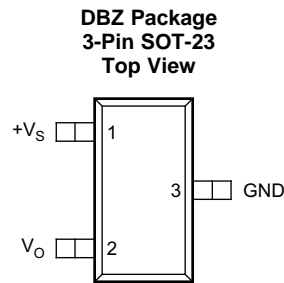
NOTE: Page numbers for previous revisions may differ from page numbers in the current version.

<b>Changes from Revision F (December 2016) to Revision G</b>	<b>Page</b>
• Changed <i>LMT90</i> to <i>LM50</i> in $V_O$ description of Equation 1 .....	8

<b>Changes from Revision E (September 2013) to Revision F</b>	<b>Page</b>
• Added <i>Device Information</i> table, <i>Pin Configuration and Functions</i> section, <i>ESD Ratings</i> table, <i>Detailed Description</i> section, <i>Application and Implementation</i> section, <i>Power Supply Recommendations</i> section, <i>Layout</i> section, <i>Device and Documentation Support</i> section, and <i>Mechanical, Packaging, and Orderable Information</i> section .....	1
• Added <i>Thermal Information</i> table .....	4
• Changed Junction-to-ambient, $R_{\theta JA}$ , value in <i>Thermal Information</i> table From: 450°C/W To: 291.9°C/W .....	4
• Deleted the <i>Temperature To Digital Converter (Parallel TRI-STATE Outputs for Standard Data Bus to <math>\mu P</math> Interface) (125°C Full Scale)</i> figure .....	11

<b>Changes from Revision C (February 2013) to Revision E</b>	<b>Page</b>
• Added LM50-Q1 option throughout document .....	1

## 5 Pin Configuration and Functions



### Pin Functions

PIN		TYPE	DESCRIPTION
NO.	NAME		
1	+VS	Power	Positive power supply pin.
2	VOU	Output	Temperature sensor analog output.
3	GND	Ground	Device ground pin, connected to power supply negative terminal.

## 6 Specifications

### 6.1 Absolute Maximum Ratings

over operating free-air temperature range (unless otherwise noted)<sup>(1)</sup>

	MIN	MAX	UNIT
Supply voltage	-0.2	12	V
Output voltage	-1	+V <sub>S</sub> + 0.6	V
Output current		10	mA
Maximum junction temperature, T <sub>J</sub>		150	°C
Storage temperature, T <sub>stg</sub>	-65	150	°C

- (1) Stresses beyond those listed under *Absolute Maximum Ratings* may cause permanent damage to the device. These are stress ratings only, which do not imply functional operation of the device at these or any other conditions beyond those indicated under *Recommended Operating Conditions*<sup>(1)</sup>. Exposure to absolute-maximum-rated conditions for extended periods may affect device reliability.

### 6.2 ESD Ratings

		VALUE	UNIT
<b>LM50</b>			
V <sub>(ESD)</sub>	Electrostatic discharge	Human body model (HBM) <sup>(1)</sup>	V
		Charged-device model (CDM)	
		Machine model <sup>(1)</sup>	
<b>LM50-Q1</b>			
V <sub>(ESD)</sub>	Electrostatic discharge	Human-body model (HBM), per AEC Q100-002 <sup>(2)</sup>	V
		Charged-device model (CDM), per AEC Q100-011	

- (1) The human body model is a 100-pF capacitor discharged through a 1.5-kΩ resistor into each pin. Machine model is a 200-pF capacitor discharged directly into each pin.  
 (2) AEC Q100-002 indicates that HBM stressing shall be in accordance with the ANSI/ESDA/JEDEC JS-001 specification.

### 6.3 Recommended Operating Conditions<sup>(1)</sup>

		MIN	MAX	UNIT	
+V <sub>S</sub>	Supply voltage	4.5	10	V	
T <sub>MIN</sub> , T <sub>MAX</sub>	Specified temperature	LM50C, LM50-Q1	–40	125	°C
		LM50B	–25	100	
Operating temperature		–40	150	°C	

- (1) Soldering process must comply with the Reflow Temperature Profile specifications. Reflow temperature profiles are different for lead-free and non-lead-free packages. Refer to [www.ti.com/packaging](http://www.ti.com/packaging).

### 6.4 Thermal Information

THERMAL METRIC <sup>(1)</sup>		LM50, LM50-Q1	UNIT
		DBZ (SOT-23)	
		3 PINS	
R <sub>θJA</sub>	Junction-to-ambient thermal resistance	291.9	°C/W
R <sub>θJC(top)</sub>	Junction-to-case (top) thermal resistance	114.3	°C/W
R <sub>θJB</sub>	Junction-to-board thermal resistance	62.3	°C/W
φ <sub>JT</sub>	Junction-to-top characterization parameter	7.4	°C/W
φ <sub>JB</sub>	Junction-to-board characterization parameter	61	°C/W

- (1) For more information about traditional and new thermal metrics, see the *Semiconductor and IC Package Thermal Metrics* application report.

### 6.5 Electrical Characteristics: LM50B

+V<sub>S</sub> = 5 V (DC) and I<sub>LOAD</sub> = 0.5 μA, in the circuit of [Figure 12](#), T<sub>A</sub> = T<sub>J</sub> = 25°C (unless otherwise noted)<sup>(1)</sup>

PARAMETER	TEST CONDITIONS	MIN	TYP	MAX	UNIT
Accuracy <sup>(2)</sup>	T <sub>A</sub> = 25°C	–2		2	°C
	T <sub>A</sub> = T <sub>MAX</sub>	–3		3	°C
	T <sub>A</sub> = T <sub>MIN</sub>	–3.5		3	°C
Nonlinearity <sup>(3)</sup>	T <sub>A</sub> = T <sub>J</sub> = T <sub>MIN</sub> to T <sub>MAX</sub>	–0.8		0.8	°C
Sensor gain (average slope)	T <sub>A</sub> = T <sub>J</sub> = T <sub>MIN</sub> to T <sub>MAX</sub>	9.7		10.3	mV/°C
Output resistance	T <sub>A</sub> = T <sub>J</sub> = T <sub>MIN</sub> to T <sub>MAX</sub>		2000	4000	Ω
Line regulation <sup>(4)</sup>	+V <sub>S</sub> = 4.5 V to 10 V, T <sub>A</sub> = T <sub>J</sub> = T <sub>MIN</sub> to T <sub>MAX</sub>	–1.2		1.2	mV/V
Quiescent current <sup>(5)</sup>	+V <sub>S</sub> = 4.5 V to 10 V, T <sub>A</sub> = T <sub>J</sub> = T <sub>MIN</sub> to T <sub>MAX</sub>			180	μA
Change of quiescent current	+V <sub>S</sub> = 4.5 V to 10 V, T <sub>A</sub> = T <sub>J</sub> = T <sub>MIN</sub> to T <sub>MAX</sub>			2	μA
Temperature coefficient of quiescent current	T <sub>A</sub> = T <sub>J</sub> = T <sub>MIN</sub> to T <sub>MAX</sub>		1		μA/°C
Long term stability <sup>(6)</sup>	T <sub>J</sub> = 125°C, for 1000 hours		±0.08		°C

- (1) Limits are specified to TI's AOQL (Average Outgoing Quality Level).
- (2) Accuracy is defined as the error between the output voltage and 10 mV/°C multiplied by the device's case temperature plus 500 mV, at specified conditions of voltage, current, and temperature (expressed in °C).
- (3) Nonlinearity is defined as the deviation of the output-voltage-versus-temperature curve from the best-fit straight line, over the device's rated temperature range.
- (4) Regulation is measured at constant junction temperature, using pulse testing with a low duty cycle. Changes in output due to heating effects can be computed by multiplying the internal dissipation by the thermal resistance.
- (5) Quiescent current is defined in the circuit of [Figure 12](#).
- (6) For best long-term stability, any precision circuit will give best results if the unit is aged at a warm temperature, and/or temperature cycled for at least 46 hours before long-term life test begins. This is especially true when a small (Surface-Mount) part is wave-soldered; allow time for stress relaxation to occur. The majority of the drift occurs in the first 1000 hours at elevated temperatures. The drift after 1000 hours does not continue at the first 1000 hour rate.

## 6.6 Electrical Characteristics: LM50C and LM50-Q1

$+V_S = 5\text{ V}$  (DC) and  $I_{LOAD} = 0.5\ \mu\text{A}$ , in the circuit of [Figure 12](#).  $T_A = T_J = 25^\circ\text{C}$ , unless otherwise noted.<sup>(1)</sup>

PARAMETER	TEST CONDITIONS	MIN	TYP	MAX	UNIT
Accuracy <sup>(2)</sup>	$T_A = 25^\circ\text{C}$	-3		3	$^\circ\text{C}$
	$T_A = T_{MAX}$	-4		4	$^\circ\text{C}$
	$T_A = T_{MIN}$	-4		4	$^\circ\text{C}$
Nonlinearity <sup>(3)</sup>	$T_A = T_J = T_{MIN}$ to $T_{MAX}$	-0.8		0.8	$^\circ\text{C}$
Sensor gain(average slope)	$T_A = T_J = T_{MIN}$ to $T_{MAX}$	9.7		10.3	mV/ $^\circ\text{C}$
Output resistance	$T_A = T_J = T_{MIN}$ to $T_{MAX}$		2000	4000	$\Omega$
Line regulation <sup>(4)</sup>	$+V_S = 4.5\text{ V}$ to $10\text{ V}$ , $T_A = T_J = T_{MIN}$ to $T_{MAX}$	-1.2		1.2	mV/V
Quiescent current <sup>(5)</sup>	$+V_S = 4.5\text{ V}$ to $10\text{ V}$ , $T_A = T_J = T_{MIN}$ to $T_{MAX}$			180	$\mu\text{A}$
Change of quiescent current	$+V_S = 4.5\text{ V}$ to $10\text{ V}$ , $T_A = T_J = T_{MIN}$ to $T_{MAX}$			2	$\mu\text{A}$
Temperature coefficient of quiescent current	$T_A = T_J = T_{MIN}$ to $T_{MAX}$		2		$\mu\text{A}/^\circ\text{C}$
Long term stability <sup>(6)</sup>	$T_J = 125^\circ\text{C}$ , for 1000 hours		$\pm 0.08$		$^\circ\text{C}$

- (1) Limits are specified to TI's AOQL (Average Outgoing Quality Level).
- (2) Accuracy is defined as the error between the output voltage and  $10\text{ mV}/^\circ\text{C}$  multiplied by the device's case temperature plus  $500\text{ mV}$ , at specified conditions of voltage, current, and temperature (expressed in  $^\circ\text{C}$ ).
- (3) Nonlinearity is defined as the deviation of the output-voltage-versus-temperature curve from the best-fit straight line, over the device's rated temperature range.
- (4) Regulation is measured at constant junction temperature, using pulse testing with a low duty cycle. Changes in output due to heating effects can be computed by multiplying the internal dissipation by the thermal resistance.
- (5) Quiescent current is defined in the circuit of [Figure 12](#).
- (6) For best long-term stability, any precision circuit will give best results if the unit is aged at a warm temperature, and/or temperature cycled for at least 46 hours before long-term life test begins. This is especially true when a small (Surface-Mount) part is wave-soldered; allow time for stress relaxation to occur. The majority of the drift occurs in the first 1000 hours at elevated temperatures. The drift after 1000 hours does not continue at the first 1000 hour rate.

## 6.7 Typical Characteristics

To generate these curves the device was mounted to a printed circuit board as shown in [Figure 20](#).

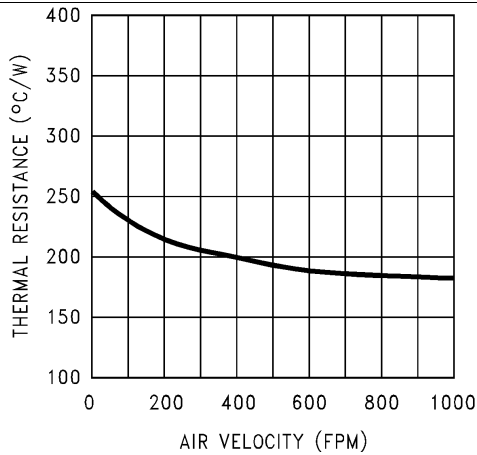


Figure 1. Junction-to-Ambient Thermal Resistance

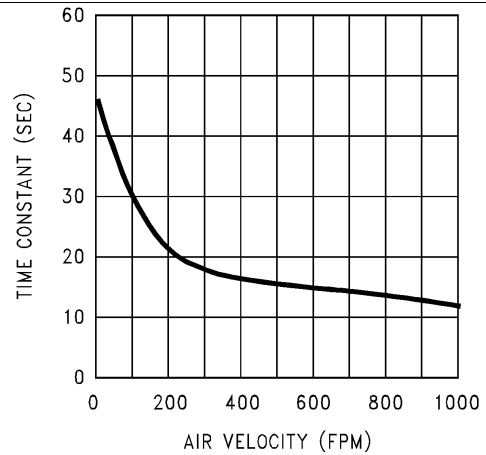


Figure 2. Thermal Time Constant

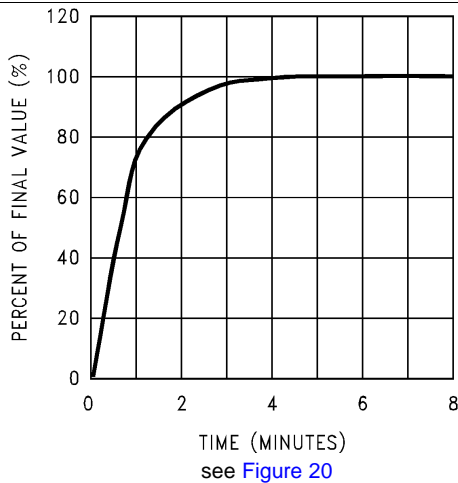


Figure 3. Thermal Response in Still Air With Heat Sink

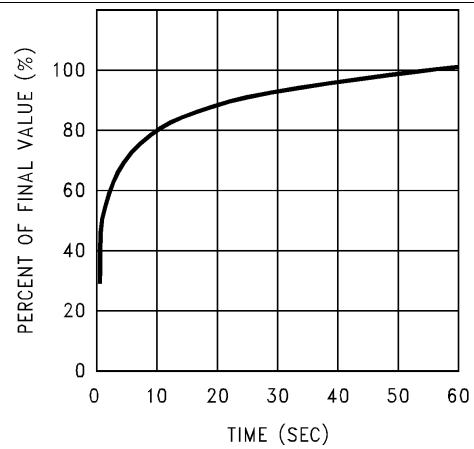


Figure 4. Thermal Response in Stirred Oil Bath With Heat Sink

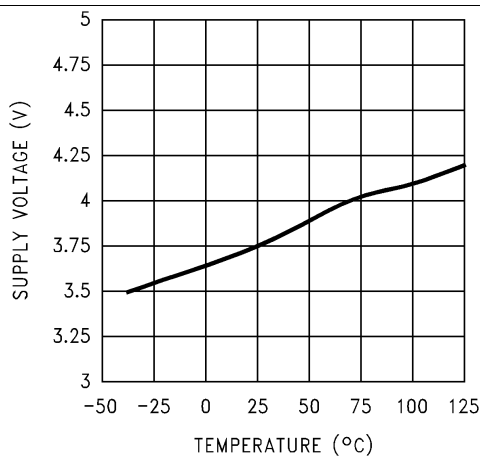


Figure 5. Start-Up Voltage vs Temperature

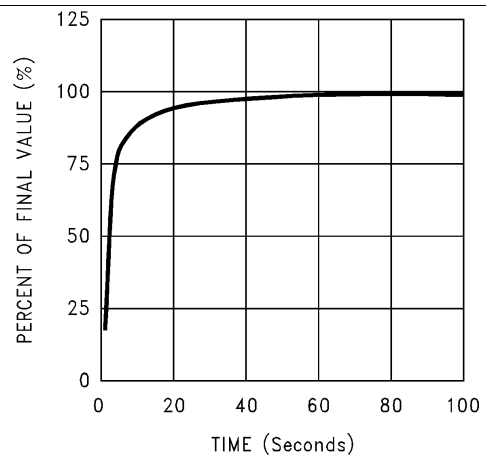
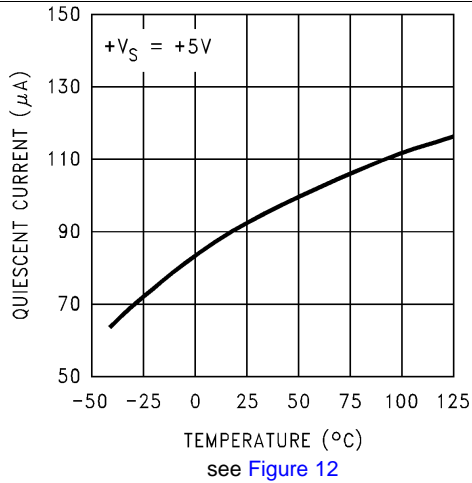


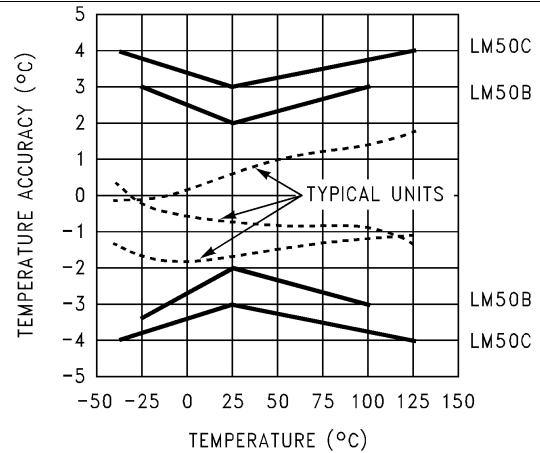
Figure 6. Thermal Response in Still Air Without a Heat Sink

### Typical Characteristics (continued)

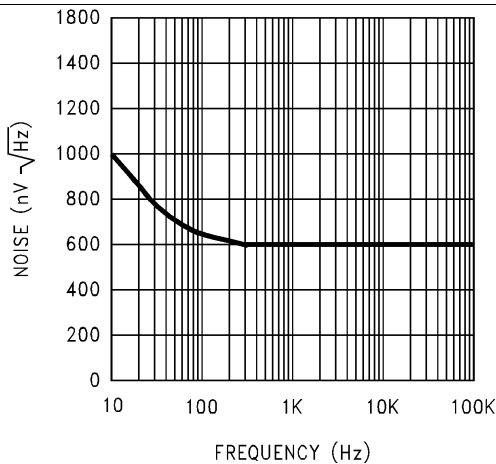
To generate these curves the device was mounted to a printed circuit board as shown in [Figure 20](#).



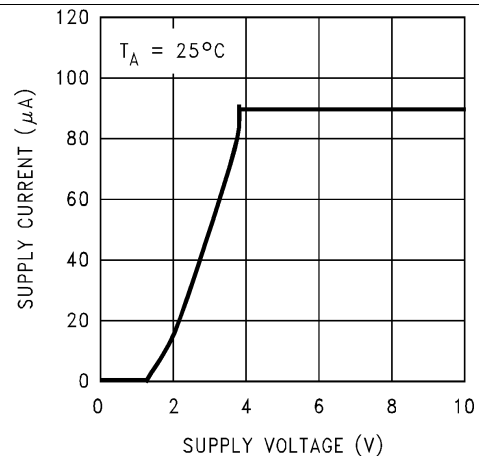
**Figure 7. Quiescent Current vs Temperature**



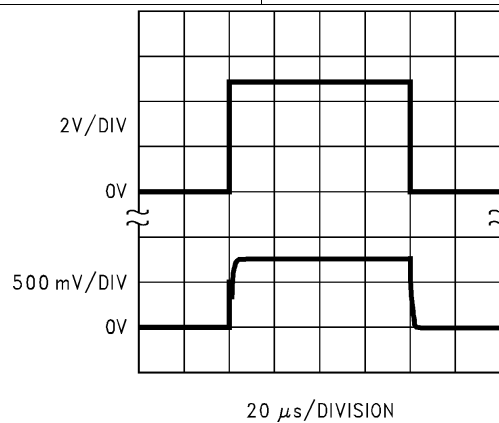
**Figure 8. Accuracy vs Temperature**



**Figure 9. Noise Voltage**



**Figure 10. Supply Voltage vs Supply Current**



**Figure 11. Start-Up Response**

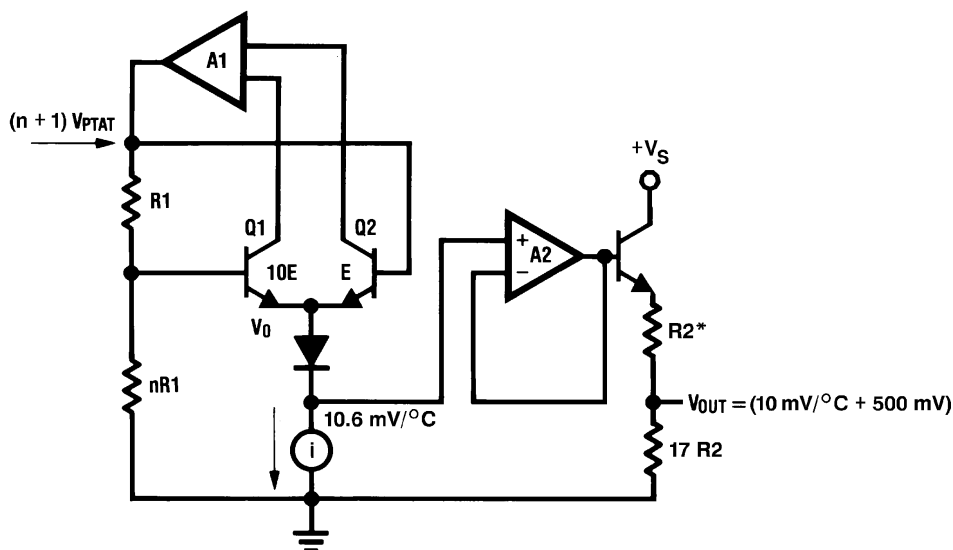
## 7 Detailed Description

### 7.1 Overview

The LM50 and LM50-Q1 devices are precision integrated-circuit temperature sensors that can sense a  $-40^{\circ}\text{C}$  to  $125^{\circ}\text{C}$  temperature range using a single positive supply. The output voltage of the LM50 and LM50-Q1 has a positive temperature slope of  $10\text{ mV}/^{\circ}\text{C}$ . A 500-mV offset is included enabling negative temperature sensing when biased by a single supply.

The temperature-sensing element is comprised of a delta- $V_{BE}$  architecture. The temperature-sensing element is then buffered by an amplifier and provided to the VOUT pin. The amplifier has a simple class A output stage with typical 2-k $\Omega$  output impedance as shown in the [Functional Block Diagram](#).

### 7.2 Functional Block Diagram



\*R2  $\approx$  2k with a typical 1300-ppm/ $^{\circ}\text{C}$  drift.

### 7.3 Feature Description

#### 7.3.1 LM50 and LM50-Q1 Transfer Function

The LM50 and LM50-Q1 follow a simple linear transfer function to achieve the accuracy as listed in the [Electrical Characteristics: LM50B](#) table and the [Electrical Characteristics: LM50C and LM50-Q1](#) table.

Use [Equation 1](#) to calculate the value of  $V_O$ .

$$V_O = 10\text{ mV}/^{\circ}\text{C} \times T\text{ }^{\circ}\text{C} + 500\text{ mV}$$

where

- T is the temperature in  $^{\circ}\text{C}$
- $V_O$  is the LM50 output voltage

(1)

### 7.4 Device Functional Modes

The only functional mode of the device has an analog output directly proportional to temperature.



## 8 Application and Implementation

### NOTE

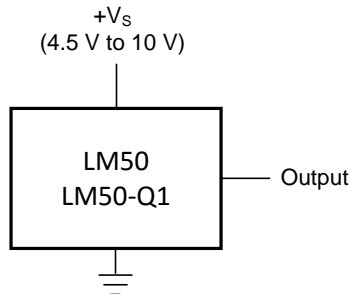
Information in the following applications sections is not part of the TI component specification, and TI does not warrant its accuracy or completeness. TI's customers are responsible for determining suitability of components for their purposes. Customers should validate and test their design implementation to confirm system functionality.

### 8.1 Application Information

The LM50 and LM50-Q1 have a wide supply range and a 10 mV/°C output slope with a 500-mV DC offset. Therefore, it can be easily applied in many temperature-sensing applications where a single supply is required for positive and negative temperatures.

### 8.2 Typical Application

#### 8.2.1 Full-Range Centigrade Temperature Sensor



Copyright © 2016, Texas Instruments Incorporated

**Figure 12. Full-Range Centigrade Temperature Sensor Diagram(–40°C to 125°C)**

##### 8.2.1.1 Design Requirements

For this design example, use the parameters listed in [Table 1](#) as the input parameters.

**Table 1. Design Parameters**

PARAMETER	VALUE
Power supply voltage	±3°C (maximum)
Output impedance	±4°C (maximum)
Accuracy at 25°C	10 mV/°C
Accuracy over –40°C to 125°C	4.5 V to 10 V
Temperature slope	4 kΩ (maximum)

##### 8.2.1.2 Detailed Design Procedure

The LM50 and LM50-Q1 are simple temperature sensors that provides an analog output. Therefore design requirements related to layout are more important than other requirements. See [Layout](#) for more information.

###### 8.2.1.2.1 Capacitive Loads

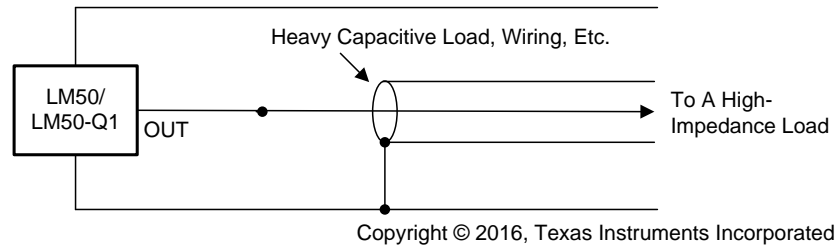
The LM50 and LM50-Q1 handle capacitive loading very well. Without any special precautions, the LM50 and LM50-Q1 can drive any capacitive load. The device has a nominal 2-kΩ output impedance (shown in [Functional Block Diagram](#)). The temperature coefficient of the output resistors is around 1300 ppm/°C. Taking into account this temperature coefficient and the initial tolerance of the resistors the output impedance of the device will not exceed 4 kΩ. In an extremely noisy environment it may be necessary to add some filtering to minimize noise pickup. TI recommends adding a 0.1-μF capacitor between +VS and GND to bypass the power supply voltage,

**LM50, LM50-Q1**

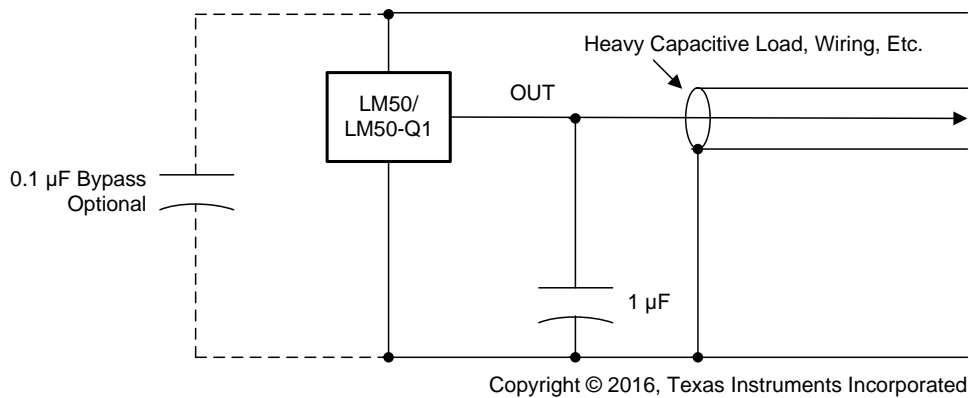
SNIS118G – JULY 1999 – REVISED JANUARY 2017

www.ti.com

as shown in Figure 14. It may also be necessary to add a capacitor from VOUT to ground. A 1-μF output capacitor with the 4-kΩ output impedance will form a 40-Hz low-pass filter. Since the thermal time constant of the LM50 and LM50-Q1 is much slower than the 25-ms time constant formed by the RC, the overall response time of the device will not be significantly affected. For much larger capacitors this additional time lag will increase the overall response time of the LM50 and LM50-Q1.

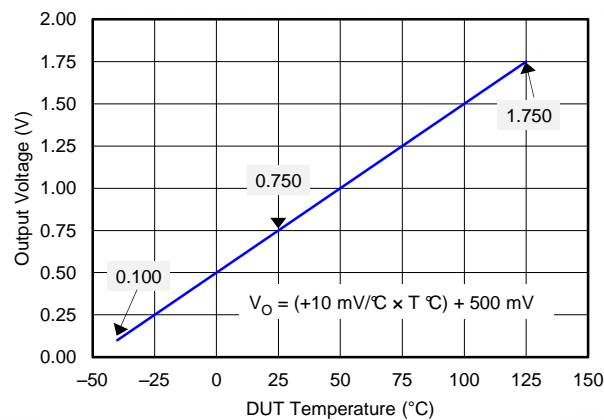


**Figure 13. LM50 and LM50-Q1 No Decoupling Required for Capacitive Load**



**Figure 14. LM50C and LM50-Q1 with Filter for Noisy Environment**

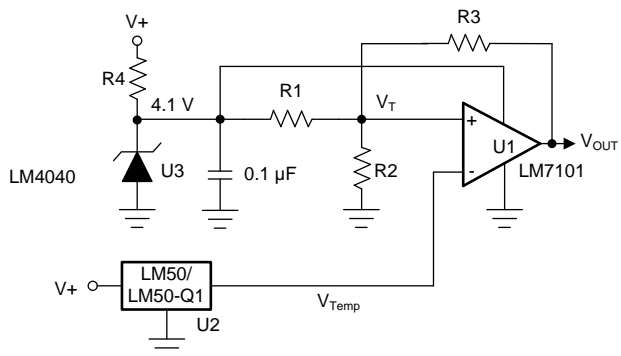
**8.2.1.3 Application Curve**



**Figure 15. Output Transfer Function**

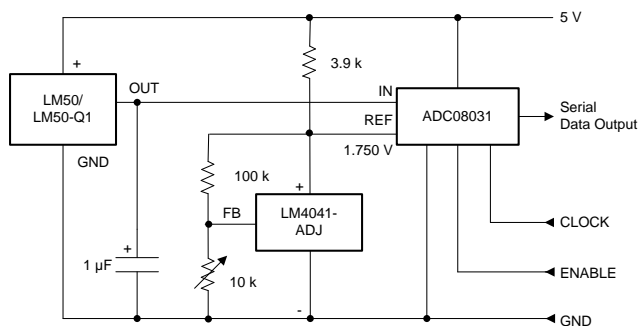
### 8.3 System Examples

Figure 16 to Figure 18 show application circuit examples using the LM50 or LM50-Q1 devices. Customers must fully validate and test any circuit before implementing a design based on an example in this section. Unless otherwise noted, the design procedures in *Full-Range Centigrade Temperature Sensor* are applicable.



Copyright © 2016, Texas Instruments Incorporated

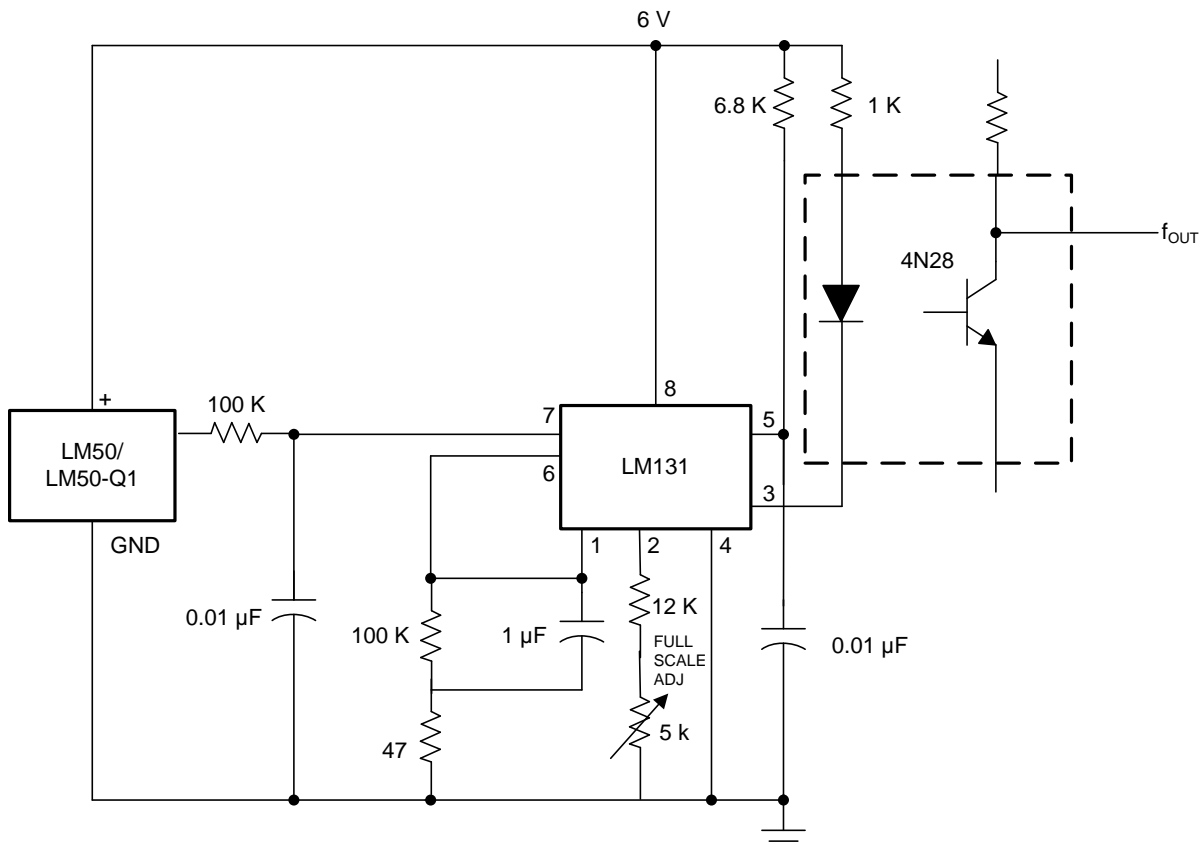
Figure 16. Centigrade Thermostat or Fan Controller



Copyright © 2016, Texas Instruments Incorporated

125°C full scale

Figure 17. Temperature To Digital Converter (Serial Output)



Copyright © 2016, Texas Instruments Incorporated

–40°C to 125°C; 100 Hz to 1750 Hz

Figure 18. LM50 or LM50-Q1 With Voltage-To-Frequency Converter and Isolated Output

## 9 Power Supply Recommendations

In an extremely noisy environment, it may be necessary to add some filtering to minimize noise pickup. TI recommends that a 0.1- $\mu$ F capacitor be added from +VS to GND to bypass the power supply voltage, as shown in [Figure 14](#).

## 10 Layout

### 10.1 Layout Guidelines

The LM50 and LM50-Q1 can be applied easily in the same way as other integrated-circuit temperature sensors. The device can be glued or cemented to a surface and its temperature will be within about 0.2°C of the surface temperature.

This presumes that the ambient air temperature is almost the same as the surface temperature; if the air temperature were much higher or lower than the surface temperature, the actual temperature of the LM50 or LM50-Q1 die would be at an intermediate temperature between the surface temperature and the air temperature.

To ensure good thermal conductivity the backside of the LM50 and LM50-Q1 die is directly attached to the GND pin. The lands and traces to the device will, of course, be part of the printed-circuit board, which is the object whose temperature is being measured. These printed-circuit board lands and traces will not cause the LM50 or LM50-Q1's temperature to deviate from the desired temperature.

Alternatively, the LM50 and LM50-Q1 can be mounted inside a sealed-end metal tube, and can then be dipped into a bath or screwed into a threaded hole in a tank. As with any IC, the LM50 and LM50-Q1 and accompanying wiring and circuits must be kept insulated and dry, to avoid leakage and corrosion. This is especially true if the circuit may operate at cold temperatures where condensation can occur. Printed-circuit coatings and varnishes such as Humiseal and epoxy paints or dips are often used to ensure that moisture cannot corrode the device or its connections.

### 10.2 Layout Example

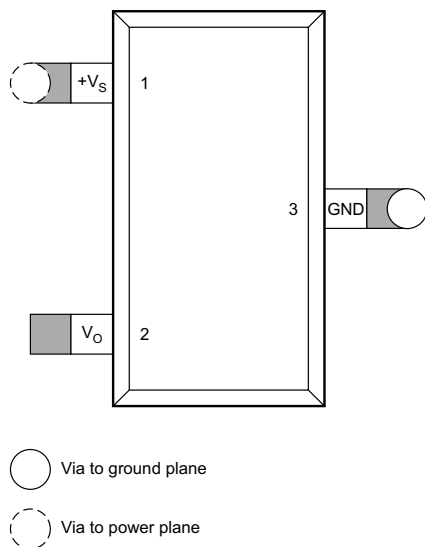
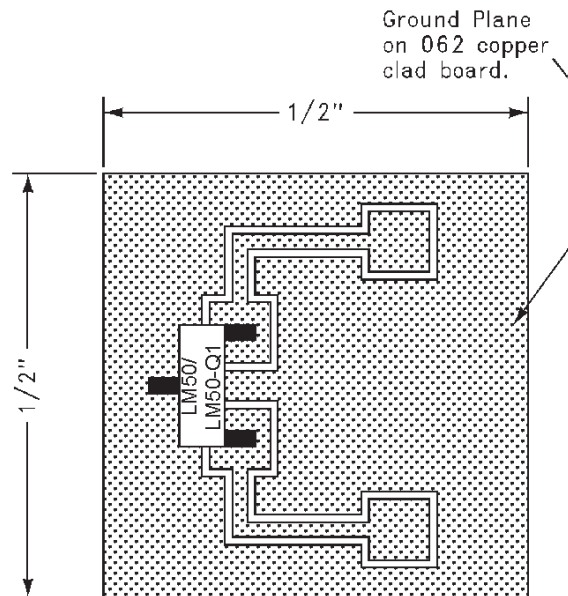


Figure 19. PCB Layout

Layout Example (continued)



1/2 in., square printed-circuit board with 2-oz foil or similar

Figure 20. Printed-Circuit Board Used for Heat Sink to Generate Thermal Response Curves

10.3 Thermal Considerations

Table 2 summarizes the thermal resistance of the LM50 and LM50-Q1 for different conditions.

Table 2. Temperature Rise of LM50 and LM50-Q1 Due to Self-Heating

			R <sub>0JA</sub> (°C/W)
SOT-23	No heat sink <sup>(1)</sup>	Still air	450
		Moving air	—
	Small heat fin <sup>(2)</sup>	Still air	260
		Moving air	180

(1) Part soldered to 30 gauge wire.

(2) Heat sink used is 1/2-in., square printed-circuit board with 2-oz foil; part attached as shown in Figure 20.

## 11 Device and Documentation Support

### 11.1 Related Links

The table below lists quick access links. Categories include technical documents, support and community resources, tools and software, and quick access to order now.

**Table 3. Related Links**

PARTS	PRODUCT FOLDER	ORDER NOW	TECHNICAL DOCUMENTS	TOOLS & SOFTWARE	SUPPORT & COMMUNITY
	<a href="#">Click here</a>	<a href="#">Click here</a>	<a href="#">Click here</a>	<a href="#">Click here</a>	<a href="#">Click here</a>
LM50-Q1	<a href="#">Click here</a>	<a href="#">Click here</a>	<a href="#">Click here</a>	<a href="#">Click here</a>	<a href="#">Click here</a>

### 11.2 Receiving Notification of Documentation Updates

To receive notification of documentation updates, navigate to the device product folder on ti.com. In the upper right corner, click on *Alert me* to register and receive a weekly digest of any product information that has changed. For change details, review the revision history included in any revised document.

### 11.3 Community Resources

The following links connect to TI community resources. Linked contents are provided "AS IS" by the respective contributors. They do not constitute TI specifications and do not necessarily reflect TI's views; see TI's [Terms of Use](#).

**TI E2E™ Online Community** *TI's Engineer-to-Engineer (E2E) Community*. Created to foster collaboration among engineers. At e2e.ti.com, you can ask questions, share knowledge, explore ideas and help solve problems with fellow engineers.

**Design Support** *TI's Design Support* Quickly find helpful E2E forums along with design support tools and contact information for technical support.

### 11.4 Trademarks

E2E is a trademark of Texas Instruments.  
All other trademarks are the property of their respective owners.

### 11.5 Electrostatic Discharge Caution



This integrated circuit can be damaged by ESD. Texas Instruments recommends that all integrated circuits be handled with appropriate precautions. Failure to observe proper handling and installation procedures can cause damage.

ESD damage can range from subtle performance degradation to complete device failure. Precision integrated circuits may be more susceptible to damage because very small parametric changes could cause the device not to meet its published specifications.

### 11.6 Glossary

[SLYZ022](#) — *TI Glossary*.

This glossary lists and explains terms, acronyms, and definitions.

## 12 Mechanical, Packaging, and Orderable Information

The following pages include mechanical, packaging, and orderable information. This information is the most current data available for the designated devices. This data is subject to change without notice and revision of this document. For browser-based versions of this data sheet, refer to the left-hand navigation.

**PACKAGING INFORMATION**

Orderable Device	Status (1)	Package Type	Package Drawing	Pins	Package Qty	Eco Plan (2)	Lead/Ball Finish (6)	MSL Peak Temp (3)	Op Temp (°C)	Device Marking (4/5)	Samples
LM50BIM3	NRND	SOT-23	DBZ	3	1000	TBD	Call TI	Call TI	-40 to 150	T5B	
LM50BIM3/NOPB	ACTIVE	SOT-23	DBZ	3	1000	Green (RoHS & no Sb/Br)	CU SN	Level-1-260C-UNLIM	-40 to 125	T5B	<a href="#">Samples</a>
LM50BIM3X/NOPB	ACTIVE	SOT-23	DBZ	3	3000	Green (RoHS & no Sb/Br)	CU SN	Level-1-260C-UNLIM	-40 to 125	T5B	<a href="#">Samples</a>
LM50CIM3	ACTIVE	SOT-23	DBZ	3	1000	TBD	Call TI	Call TI	-40 to 125	T5C	<a href="#">Samples</a>
LM50CIM3/NOPB	ACTIVE	SOT-23	DBZ	3	1000	Green (RoHS & no Sb/Br)	CU SN	Level-1-260C-UNLIM	-40 to 125	T5C	<a href="#">Samples</a>
LM50CIM3X	NRND	SOT-23	DBZ	3	3000	TBD	Call TI	Call TI	-40 to 150	T5C	
LM50CIM3X/NOPB	ACTIVE	SOT-23	DBZ	3	3000	Green (RoHS & no Sb/Br)	CU SN	Level-1-260C-UNLIM	-40 to 125	T5C	<a href="#">Samples</a>
LM50QIM3/NOPB	ACTIVE	SOT-23	DBZ	3	1000	Green (RoHS & no Sb/Br)	CU SN	Level-1-260C-UNLIM	-40 to 125	T5Q	<a href="#">Samples</a>
LM50QIM3X/NOPB	ACTIVE	SOT-23	DBZ	3	3000	Green (RoHS & no Sb/Br)	CU SN	Level-1-260C-UNLIM	-40 to 125	T5Q	<a href="#">Samples</a>

(1) The marketing status values are defined as follows:

**ACTIVE:** Product device recommended for new designs.

**LIFEBUY:** TI has announced that the device will be discontinued, and a lifetime-buy period is in effect.

**NRND:** Not recommended for new designs. Device is in production to support existing customers, but TI does not recommend using this part in a new design.

**PREVIEW:** Device has been announced but is not in production. Samples may or may not be available.

**OBSOLETE:** TI has discontinued the production of the device.

(2) **RoHS:** TI defines "RoHS" to mean semiconductor products that are compliant with the current EU RoHS requirements for all 10 RoHS substances, including the requirement that RoHS substance do not exceed 0.1% by weight in homogeneous materials. Where designed to be soldered at high temperatures, "RoHS" products are suitable for use in specified lead-free processes. TI may reference these types of products as "Pb-Free".

**RoHS Exempt:** TI defines "RoHS Exempt" to mean products that contain lead but are compliant with EU RoHS pursuant to a specific EU RoHS exemption.

**Green:** TI defines "Green" to mean the content of Chlorine (Cl) and Bromine (Br) based flame retardants meet JS709B low halogen requirements of <=1000ppm threshold. Antimony trioxide based flame retardants must also meet the <=1000ppm threshold requirement.

(3) MSL, Peak Temp. - The Moisture Sensitivity Level rating according to the JEDEC industry standard classifications, and peak solder temperature.

(4) There may be additional marking, which relates to the logo, the lot trace code information, or the environmental category on the device.

(5) Multiple Device Markings will be inside parentheses. Only one Device Marking contained in parentheses and separated by a "-" will appear on a device. If a line is indented then it is a continuation of the previous line and the two combined represent the entire Device Marking for that device.

(6) Lead/Ball Finish - Orderable Devices may have multiple material finish options. Finish options are separated by a vertical ruled line. Lead/Ball Finish values may wrap to two lines if the finish value exceeds the maximum column width.

**Important Information and Disclaimer:**The information provided on this page represents TI's knowledge and belief as of the date that it is provided. TI bases its knowledge and belief on information provided by third parties, and makes no representation or warranty as to the accuracy of such information. Efforts are underway to better integrate information from third parties. TI has taken and continues to take reasonable steps to provide representative and accurate information but may not have conducted destructive testing or chemical analysis on incoming materials and chemicals. TI and TI suppliers consider certain information to be proprietary, and thus CAS numbers and other limited information may not be available for release.

In no event shall TI's liability arising out of such information exceed the total purchase price of the TI part(s) at issue in this document sold by TI to Customer on an annual basis.

**OTHER QUALIFIED VERSIONS OF LM50, LM50-Q1 :**

- Catalog: [LM50](#)
- Automotive: [LM50-Q1](#)

NOTE: Qualified Version Definitions:

- Catalog - TI's standard catalog product
- Automotive - Q100 devices qualified for high-reliability automotive applications targeting zero defects



**TAPE AND REEL INFORMATION**

**QUADRANT ASSIGNMENTS FOR PIN 1 ORIENTATION IN TAPE**


\*All dimensions are nominal

Device	Package Type	Package Drawing	Pins	SPQ	Reel Diameter (mm)	Reel Width W1 (mm)	A0 (mm)	B0 (mm)	K0 (mm)	P1 (mm)	W (mm)	Pin1 Quadrant
LM50BIM3	SOT-23	DBZ	3	1000	178.0	8.4	3.3	2.9	1.22	4.0	8.0	Q3
LM50BIM3/NOPB	SOT-23	DBZ	3	1000	178.0	8.4	3.3	2.9	1.22	4.0	8.0	Q3
LM50BIM3X/NOPB	SOT-23	DBZ	3	3000	178.0	8.4	3.3	2.9	1.22	4.0	8.0	Q3
LM50CIM3	SOT-23	DBZ	3	1000	178.0	8.4	3.3	2.9	1.22	4.0	8.0	Q3
LM50CIM3/NOPB	SOT-23	DBZ	3	1000	178.0	8.4	3.3	2.9	1.22	4.0	8.0	Q3
LM50CIM3X	SOT-23	DBZ	3	3000	178.0	8.4	3.3	2.9	1.22	4.0	8.0	Q3
LM50CIM3X/NOPB	SOT-23	DBZ	3	3000	178.0	8.4	3.3	2.9	1.22	4.0	8.0	Q3
LM50QIM3/NOPB	SOT-23	DBZ	3	1000	178.0	8.4	3.3	2.9	1.22	4.0	8.0	Q3
LM50QIM3X/NOPB	SOT-23	DBZ	3	3000	178.0	8.4	3.3	2.9	1.22	4.0	8.0	Q3

**TAPE AND REEL BOX DIMENSIONS**


\*All dimensions are nominal

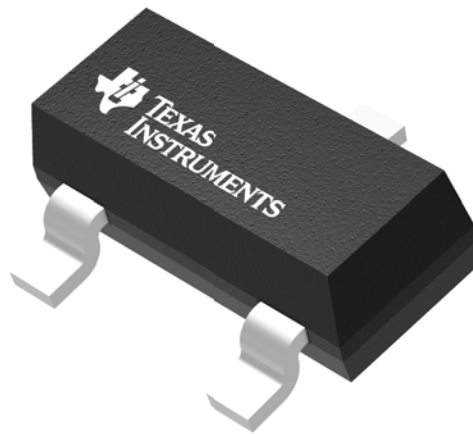
Device	Package Type	Package Drawing	Pins	SPQ	Length (mm)	Width (mm)	Height (mm)
LM50BIM3	SOT-23	DBZ	3	1000	210.0	185.0	35.0
LM50BIM3/NOPB	SOT-23	DBZ	3	1000	210.0	185.0	35.0
LM50BIM3X/NOPB	SOT-23	DBZ	3	3000	210.0	185.0	35.0
LM50CIM3	SOT-23	DBZ	3	1000	210.0	185.0	35.0
LM50CIM3/NOPB	SOT-23	DBZ	3	1000	210.0	185.0	35.0
LM50CIM3X	SOT-23	DBZ	3	3000	210.0	185.0	35.0
LM50CIM3X/NOPB	SOT-23	DBZ	3	3000	210.0	185.0	35.0
LM50QIM3/NOPB	SOT-23	DBZ	3	1000	210.0	185.0	35.0
LM50QIM3X/NOPB	SOT-23	DBZ	3	3000	210.0	185.0	35.0

## GENERIC PACKAGE VIEW

**DBZ 3**

**SOT-23 - 1.12 mm max height**

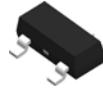
SMALL OUTLINE TRANSISTOR



Images above are just a representation of the package family, actual package may vary.  
Refer to the product data sheet for package details.

4203227/C

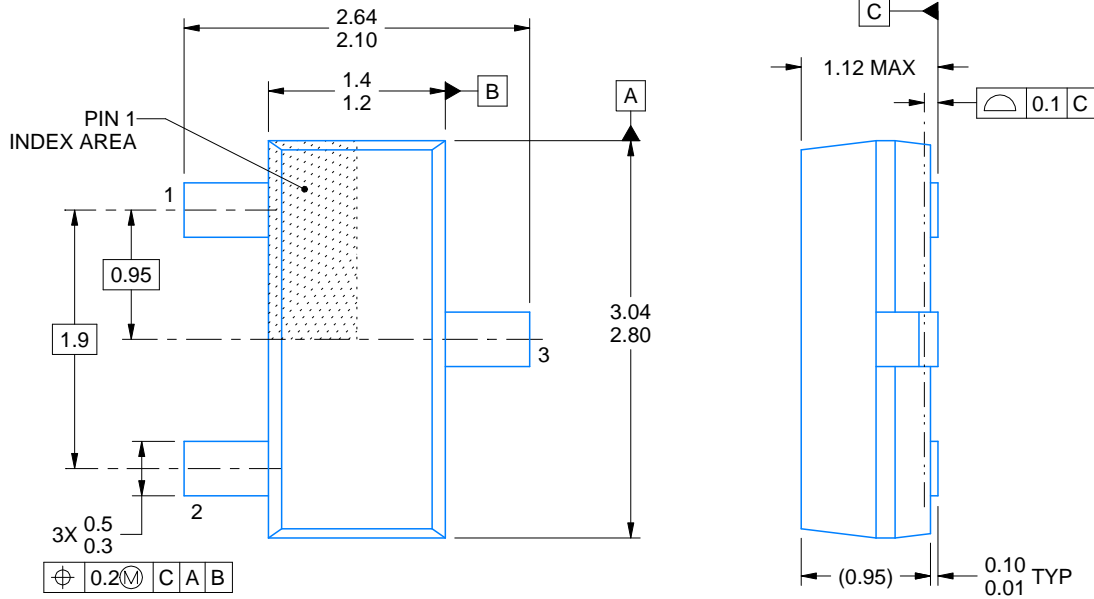
DBZ0003A



# PACKAGE OUTLINE

SOT-23 - 1.12 mm max height

SMALL OUTLINE TRANSISTOR



4214838/C 04/2017

NOTES:

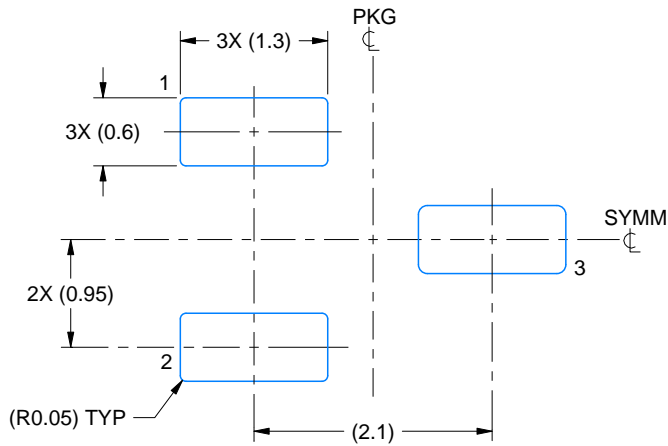
1. All linear dimensions are in millimeters. Any dimensions in parenthesis are for reference only. Dimensioning and tolerancing per ASME Y14.5M.
2. This drawing is subject to change without notice.
3. Reference JEDEC registration TO-236, except minimum foot length.

# EXAMPLE BOARD LAYOUT

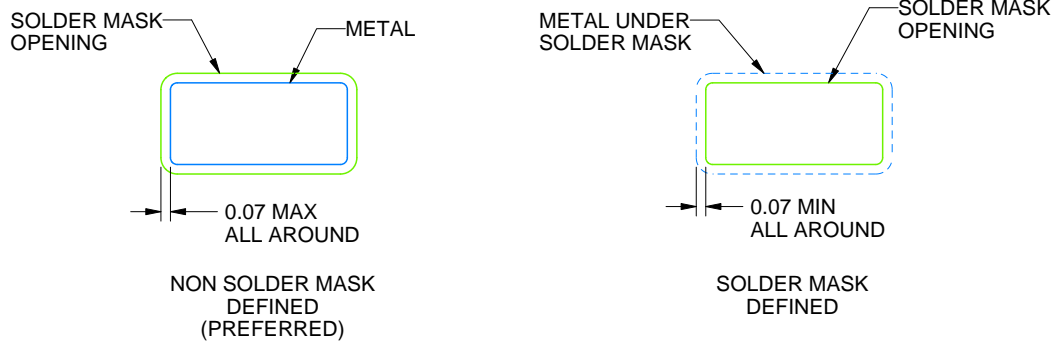
DBZ0003A

SOT-23 - 1.12 mm max height

SMALL OUTLINE TRANSISTOR



LAND PATTERN EXAMPLE  
SCALE:15X



SOLDER MASK DETAILS

4214838/C 04/2017

NOTES: (continued)

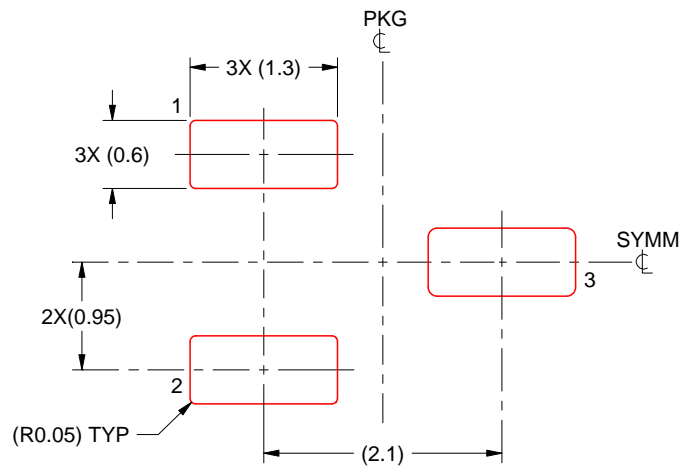
4. Publication IPC-7351 may have alternate designs.
5. Solder mask tolerances between and around signal pads can vary based on board fabrication site.

# EXAMPLE STENCIL DESIGN

DBZ0003A

SOT-23 - 1.12 mm max height

SMALL OUTLINE TRANSISTOR



SOLDER PASTE EXAMPLE  
BASED ON 0.125 THICK STENCIL  
SCALE:15X

4214838/C 04/2017

NOTES: (continued)

6. Laser cutting apertures with trapezoidal walls and rounded corners may offer better paste release. IPC-7525 may have alternate design recommendations.
7. Board assembly site may have different recommendations for stencil design.

## IMPORTANT NOTICE

Texas Instruments Incorporated (TI) reserves the right to make corrections, enhancements, improvements and other changes to its semiconductor products and services per JESD46, latest issue, and to discontinue any product or service per JESD48, latest issue. Buyers should obtain the latest relevant information before placing orders and should verify that such information is current and complete.

TI's published terms of sale for semiconductor products (<http://www.ti.com/sc/docs/stdterms.htm>) apply to the sale of packaged integrated circuit products that TI has qualified and released to market. Additional terms may apply to the use or sale of other types of TI products and services.

Reproduction of significant portions of TI information in TI data sheets is permissible only if reproduction is without alteration and is accompanied by all associated warranties, conditions, limitations, and notices. TI is not responsible or liable for such reproduced documentation. Information of third parties may be subject to additional restrictions. Resale of TI products or services with statements different from or beyond the parameters stated by TI for that product or service voids all express and any implied warranties for the associated TI product or service and is an unfair and deceptive business practice. TI is not responsible or liable for any such statements.

Buyers and others who are developing systems that incorporate TI products (collectively, "Designers") understand and agree that Designers remain responsible for using their independent analysis, evaluation and judgment in designing their applications and that Designers have full and exclusive responsibility to assure the safety of Designers' applications and compliance of their applications (and of all TI products used in or for Designers' applications) with all applicable regulations, laws and other applicable requirements. Designer represents that, with respect to their applications, Designer has all the necessary expertise to create and implement safeguards that (1) anticipate dangerous consequences of failures, (2) monitor failures and their consequences, and (3) lessen the likelihood of failures that might cause harm and take appropriate actions. Designer agrees that prior to using or distributing any applications that include TI products, Designer will thoroughly test such applications and the functionality of such TI products as used in such applications.

TI's provision of technical, application or other design advice, quality characterization, reliability data or other services or information, including, but not limited to, reference designs and materials relating to evaluation modules, (collectively, "TI Resources") are intended to assist designers who are developing applications that incorporate TI products; by downloading, accessing or using TI Resources in any way, Designer (individually or, if Designer is acting on behalf of a company, Designer's company) agrees to use any particular TI Resource solely for this purpose and subject to the terms of this Notice.

TI's provision of TI Resources does not expand or otherwise alter TI's applicable published warranties or warranty disclaimers for TI products, and no additional obligations or liabilities arise from TI providing such TI Resources. TI reserves the right to make corrections, enhancements, improvements and other changes to its TI Resources. TI has not conducted any testing other than that specifically described in the published documentation for a particular TI Resource.

Designer is authorized to use, copy and modify any individual TI Resource only in connection with the development of applications that include the TI product(s) identified in such TI Resource. NO OTHER LICENSE, EXPRESS OR IMPLIED, BY ESTOPPEL OR OTHERWISE TO ANY OTHER TI INTELLECTUAL PROPERTY RIGHT, AND NO LICENSE TO ANY TECHNOLOGY OR INTELLECTUAL PROPERTY RIGHT OF TI OR ANY THIRD PARTY IS GRANTED HEREIN, including but not limited to any patent right, copyright, mask work right, or other intellectual property right relating to any combination, machine, or process in which TI products or services are used. Information regarding or referencing third-party products or services does not constitute a license to use such products or services, or a warranty or endorsement thereof. Use of TI Resources may require a license from a third party under the patents or other intellectual property of the third party, or a license from TI under the patents or other intellectual property of TI.

TI RESOURCES ARE PROVIDED "AS IS" AND WITH ALL FAULTS. TI DISCLAIMS ALL OTHER WARRANTIES OR REPRESENTATIONS, EXPRESS OR IMPLIED, REGARDING RESOURCES OR USE THEREOF, INCLUDING BUT NOT LIMITED TO ACCURACY OR COMPLETENESS, TITLE, ANY EPIDEMIC FAILURE WARRANTY AND ANY IMPLIED WARRANTIES OF MERCHANTABILITY, FITNESS FOR A PARTICULAR PURPOSE, AND NON-INFRINGEMENT OF ANY THIRD PARTY INTELLECTUAL PROPERTY RIGHTS. TI SHALL NOT BE LIABLE FOR AND SHALL NOT DEFEND OR INDEMNIFY DESIGNER AGAINST ANY CLAIM, INCLUDING BUT NOT LIMITED TO ANY INFRINGEMENT CLAIM THAT RELATES TO OR IS BASED ON ANY COMBINATION OF PRODUCTS EVEN IF DESCRIBED IN TI RESOURCES OR OTHERWISE. IN NO EVENT SHALL TI BE LIABLE FOR ANY ACTUAL, DIRECT, SPECIAL, COLLATERAL, INDIRECT, PUNITIVE, INCIDENTAL, CONSEQUENTIAL OR EXEMPLARY DAMAGES IN CONNECTION WITH OR ARISING OUT OF TI RESOURCES OR USE THEREOF, AND REGARDLESS OF WHETHER TI HAS BEEN ADVISED OF THE POSSIBILITY OF SUCH DAMAGES.

Unless TI has explicitly designated an individual product as meeting the requirements of a particular industry standard (e.g., ISO/TS 16949 and ISO 26262), TI is not responsible for any failure to meet such industry standard requirements.

Where TI specifically promotes products as facilitating functional safety or as compliant with industry functional safety standards, such products are intended to help enable customers to design and create their own applications that meet applicable functional safety standards and requirements. Using products in an application does not by itself establish any safety features in the application. Designers must ensure compliance with safety-related requirements and standards applicable to their applications. Designer may not use any TI products in life-critical medical equipment unless authorized officers of the parties have executed a special contract specifically governing such use. Life-critical medical equipment is medical equipment where failure of such equipment would cause serious bodily injury or death (e.g., life support, pacemakers, defibrillators, heart pumps, neurostimulators, and implantables). Such equipment includes, without limitation, all medical devices identified by the U.S. Food and Drug Administration as Class III devices and equivalent classifications outside the U.S.

TI may expressly designate certain products as completing a particular qualification (e.g., Q100, Military Grade, or Enhanced Product). Designers agree that it has the necessary expertise to select the product with the appropriate qualification designation for their applications and that proper product selection is at Designers' own risk. Designers are solely responsible for compliance with all legal and regulatory requirements in connection with such selection.

Designer will fully indemnify TI and its representatives against any damages, costs, losses, and/or liabilities arising out of Designer's non-compliance with the terms and provisions of this Notice.