

Micro Switch Series

KLS7-KW4-3Z Micro Switch Series

Features

Small contact clearance, high sensitivity
 High precision and high repeat accuracy Flexible operating travel, wide range of operating force Wide variety of terminal types
 Wide variety of actuator forms
 Adopt flame-retarded and fiber enhanced thermoplastics
 Long life cycles, high reliability
 Various approvals

Application

Widely applied in home appliances, medical devices, office facility, instrument and apparatus, electric motion tools, packing machinery, auto electronics etc.
 Examples: vending machines, gaming machines, coffee machines, dishwashers, dryers, washing machines, microwave ovens, Central water heating, vacuum cleaners, water pump, projecting apparatus, industrial automations etc.



Specifications

Items		Value
Operating speed		0.1mm~1m/S
Operating Frequency		Mechanical 60cycles/min; Electrical 25cycles/min
Insulation resistance		≥100MΩ (DC500V)
Contact resistance		≤30mΩ (Initial value)
Test voltage	Between terminals of same polarity	AC1500V 50/60HZ
	Between current-carrying metal parts and ground (case)	AC3750V 50/60HZ
Vibration resistance		10~55 HZ 1.5mm Double amplitude
Shock resistance		Destruction: OF>0.5N: 1000m/S ² (approx. 100G) Max OF≤0.5N: 400m/S ² (approx. 40G) Max
		Malfunction: OF>0.5N: 200m/S ² (approx. 20G) Max OF≤0.5N: 100m/S ² (approx. 10G) Max
Life expectancy		Mechanical ≥2000000cycles
		Electrical ≥50000cycles
Degree of protection against electric		Class I /Class II
PTI		175
Approvals		UL CUL VDE TUV CE DEMKO CQC

Micro Switch Series

KLS7-KW4-3Z Micro Switch Series

ORDER INFORMATION

VII

KLS7-KW4-3Z- X X X X X X X - X

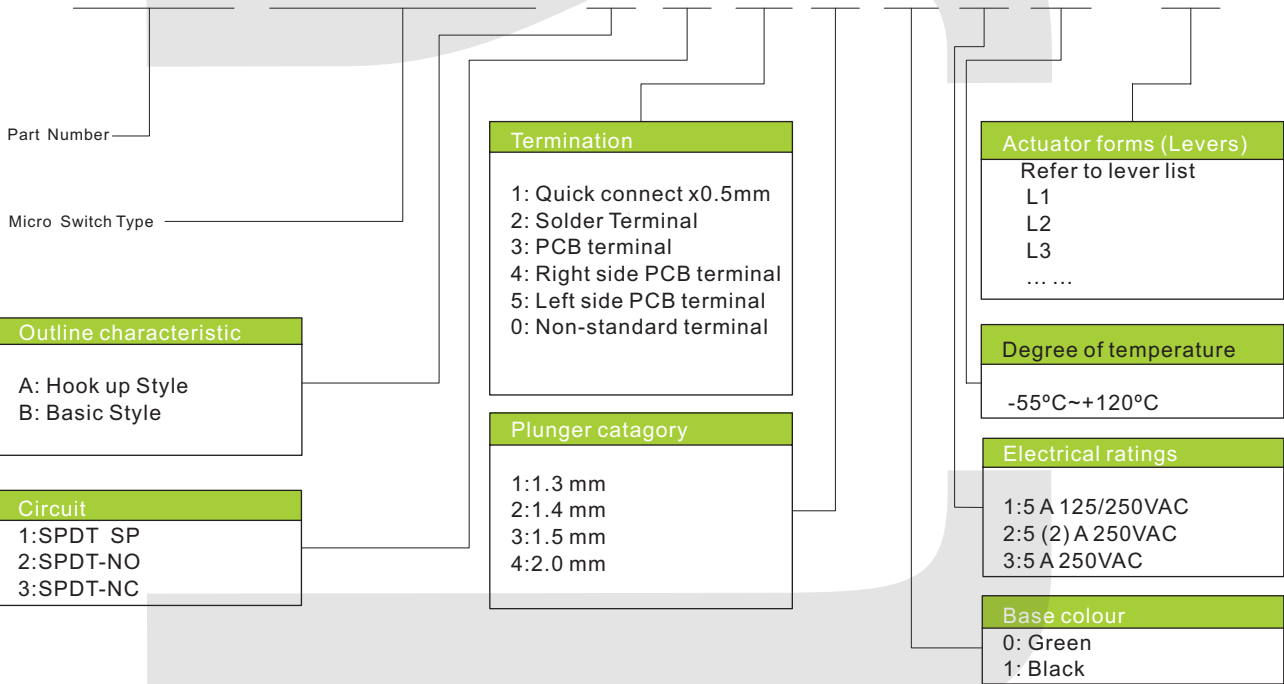

Outline Characteristic

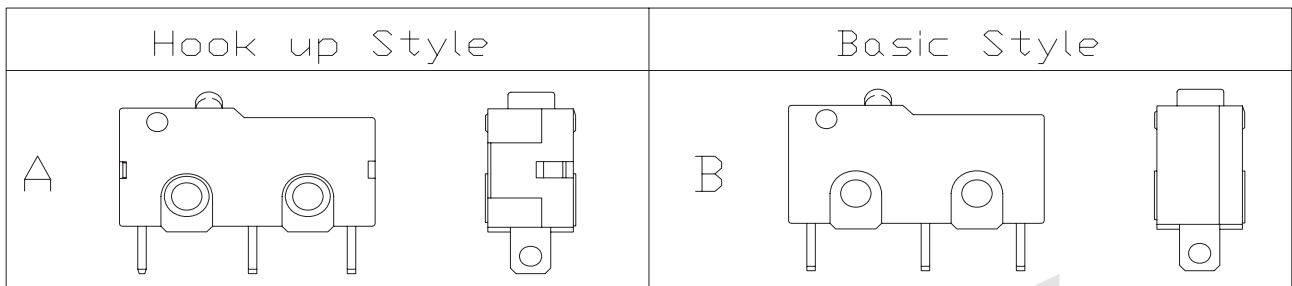

Circuit Illustration

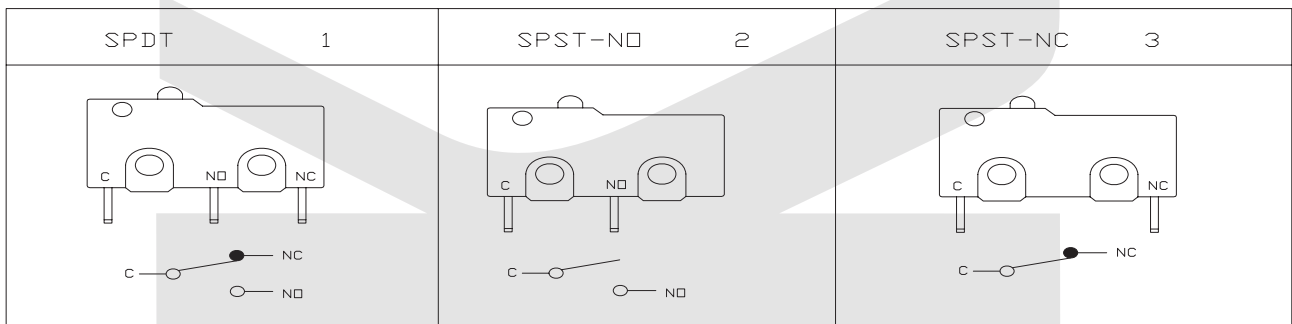

Micro Switch Series

KLS7-KW4-3Z Micro Switch Series

Mounting Hole Dimensions

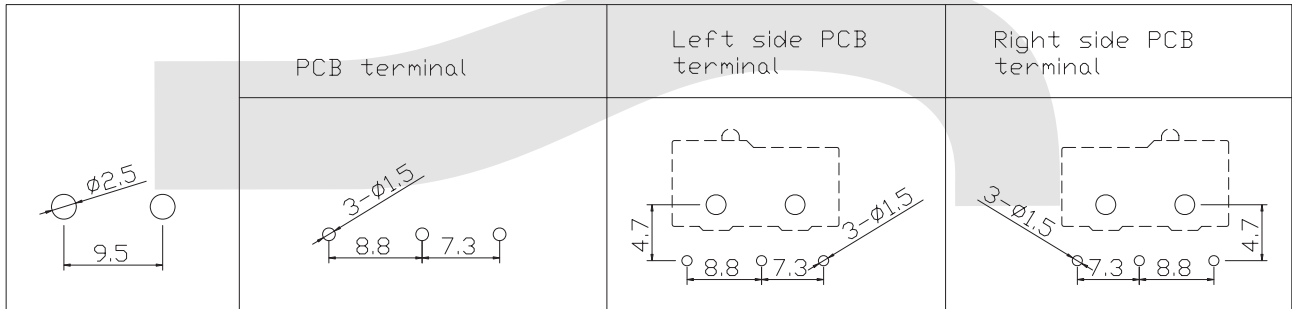

Terminal dimensions

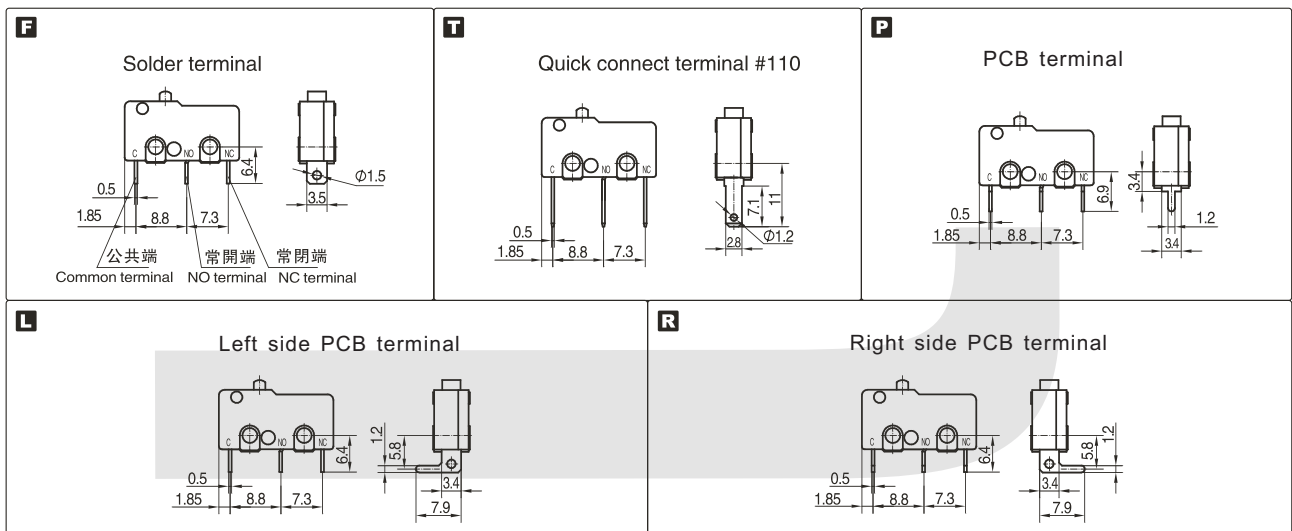

Internal configuration drawing

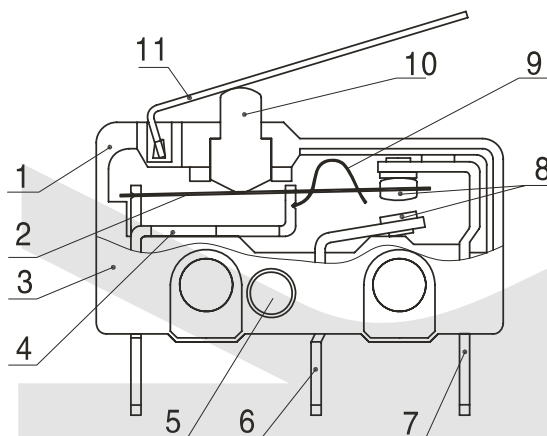

- 1 Case
- 2 Moving piece
- 3 Cover
- 4 Support
- 5 Rivet
- 6 NO terminal
- 7 NC terminal
- 8 Contact
- 9 Spring
- 10 Plunger
- 11 Moving arm(Lever)

Micro Switch Series

KLS7-KW4-3Z Micro Switch Series

 KLS7-KW4-3Z-A122013L

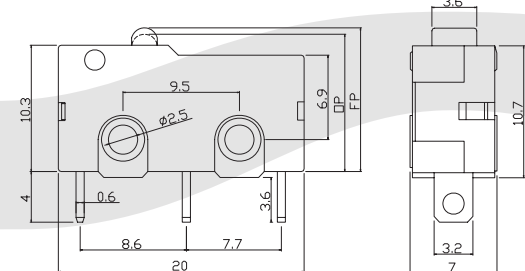

Model	KLS7-KW4-3Z-A122013L
DF (N)	0.2~3.0
MD Max(mm)	0.2
PT Max(mm)	12.2
DP Min(mm)	11.0

 KLS7-KW4-3Z-B122013L

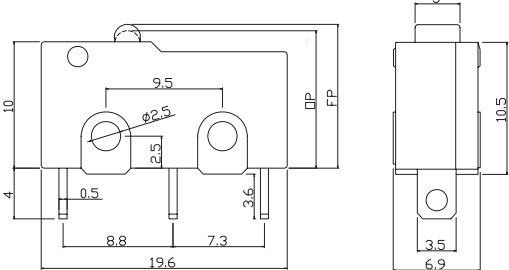

Model	KLS7-KW4-3Z-B122013L
DF (N)	0.2~3.0
MD Max(mm)	0.2
PT Max(mm)	12.2
DP Min(mm)	11.0

 KLS7-KW4-3Z-B222013L

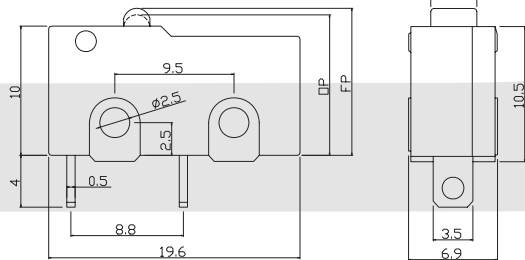

Model	KLS7-KW4-3Z-B222013L
DF (N)	0.2~3.0
MD Max(mm)	0.2
PT Max(mm)	12.2
DP Min(mm)	11.0

 KLS7-KW4-3Z-B122013L1

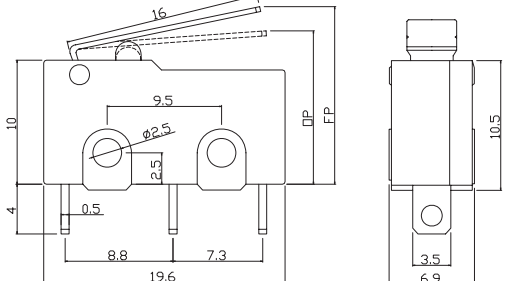

Model	KLS7-KW4-3Z-B122013L1
DF (N)	0.2~3.0
MD Max(mm)	1.2
PT Max(mm)	14.5
DP Min(mm)	10.5

 KLS7-KW4-3Z-B222013L1

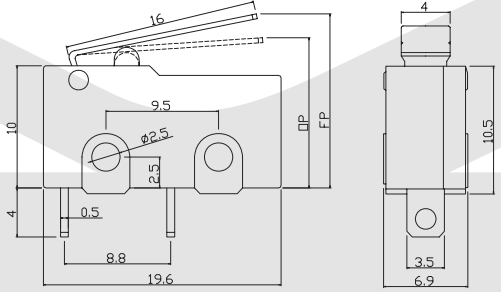

Model	KLS7-KW4-3Z-B222013L1
DF (N)	0.2~3.0
MD Max(mm)	1.2
PT Max(mm)	14.5
DP Min(mm)	10.5

Micro Switch Series

KLS7-KW4-3Z Micro Switch Series



KLS7-KW4-3Z-B122013L2

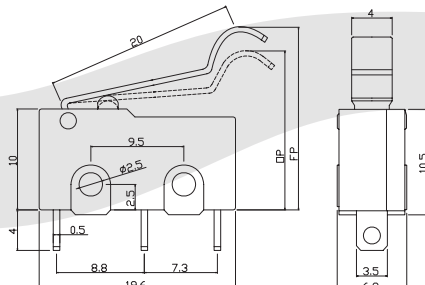

Model	KLS7-KW4-3Z-B122013L2
DF (N)	0.2~3.0
MD Max(mm)	1.2
PT Max(mm)	17.0
DP Min(mm)	13.0



KLS7-KW4-3Z-B222013L2

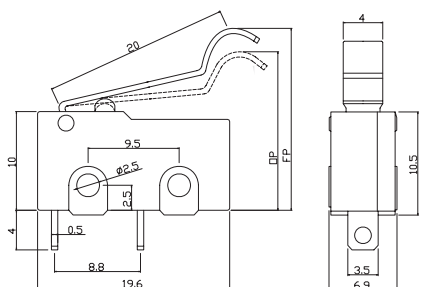

Model	KLS7-KW4-3Z-B222013L2
DF (N)	0.2~3.0
MD Max(mm)	1.2
PT Max(mm)	17.0
DP Min(mm)	13.0



KLS7-KW4-3Z-B132013L

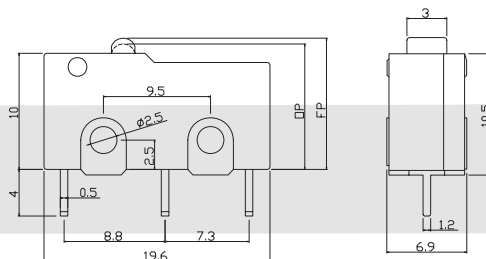

Model	KLS7-KW4-3Z-B132013L
DF (N)	0.2~3.0
MD Max(mm)	0.2
PT Max(mm)	12.0
DP Min(mm)	11.0



KLS7-KW4-3Z-B232013L

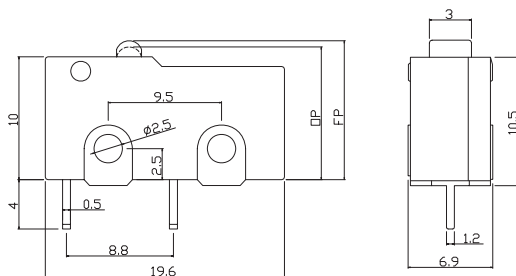

Model	KLS7-KW4-3Z-B232013L
DF (N)	0.2~3.0
MD Max(mm)	0.2
PT Max(mm)	12.0
DP Min(mm)	11.0



KLS7-KW4-3Z-B122013L3

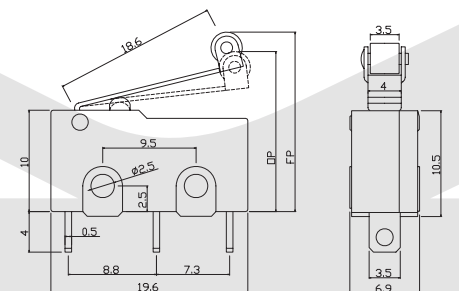

Model	KLS7-KW4-3Z-B122013L3
DF (N)	0.2~3.0
MD Max(mm)	1.2
PT Max(mm)	19.5
DP Min(mm)	16.0

Micro Switch Series

KLS7-KW4-3Z Micro Switch Series

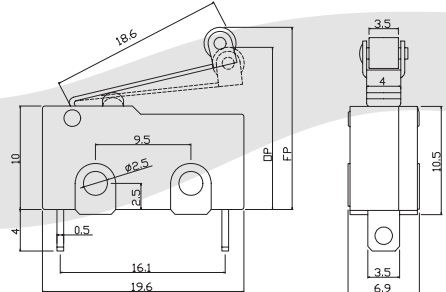

Model	KLS7-KW4-3Z-B322013L3
DF <N>	0.2~3.0
MD Max<mm>	1.2
PT Max<mm>	19.5
DP Min<mm>	16.0

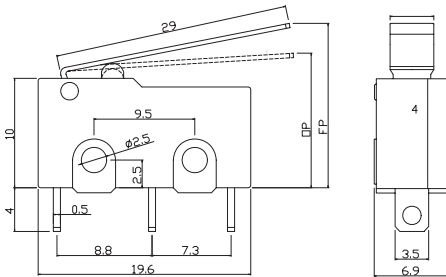

Model	KLS7-KW4-3Z-B122013L4
DF <N>	0.2~3.0
MD Max<mm>	1.5
PT Max<mm>	18.0
DP Min<mm>	14.5

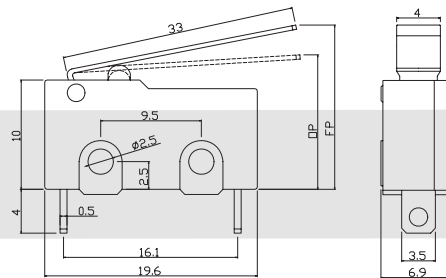

Model	KLS7-KW4-3Z-B322013L4
DF <N>	0.2~3.0
MD Max<mm>	1.5
PT Max<mm>	18.0
DP Min<mm>	14.5

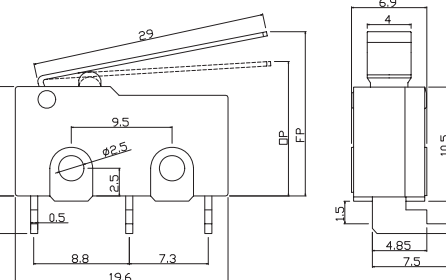

Model	KLS7-KW4-3Z-B152013L4
DF <N>	0.2~3.0
MD Max<mm>	1.5
PT Max<mm>	18.0
DP Min<mm>	14.5

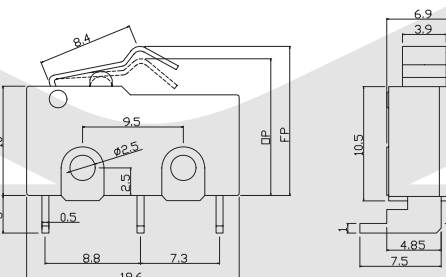

Model	KLS7-KW4-3Z-B142013L5
DF <N>	0.2~3.0
MD Max<mm>	0.5
PT Max<mm>	15.5
DP Min<mm>	14.1

Micro Switch Series

KLS7-KW4-3Z Micro Switch Series

VII



KLS7-KW4-3Z-B122013L8

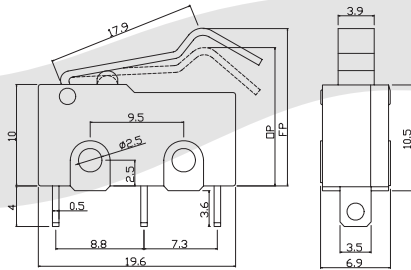

Model	KLS7-KW4-3Z-B122013L8
DF (N)	0.2~3.0
MD Max(mm)	1.0
PT Max(mm)	18.0
DP Min(mm)	13.5



KLS7-KW4-3Z-B112013L17

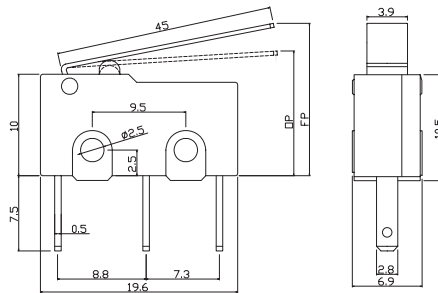

Model	KLS7-KW4-3Z-B112013L17
DF (N)	0.2~3.0
MD Max(mm)	2.0
PT Max(mm)	20.0
DP Min(mm)	14.0