

PRODUCT SPECIFICATION

Model No.: FYL-5014PURC1H-TL

Descriptions:
■Dice material: AlGaInP.
■Emitting Color: Super bright Red.
■Device Outline: Φ5mm round type.
■Lens Type: Water clear.



CUSTOMER APPROVED SIGNATURES	APPROVED BY	CHECKED BY	PREPARED BY

NINGBO FORYARD OPTOELECTRONICS CO.,LTD.

Add:NO.115 Qixin Road Ningbo Zhejiang China

Zip:315051

Tel: 0086-574-87933652 87927870 87922206

Fax: 0086-574-87927917

E-mail: Sales@foryard.com (General)

[Http://www.foryard.com](http://www.foryard.com)

■ Absolute maximum ratings($T_a=25\text{ }^\circ\text{C}$)

Parameter	MAX.	Unit
Power Dissipation	75	mW
Peak Forward Current (1/10 Duty Cycle, 0.1ms Pulse Width)	100	mA
Continuous Forward Current	30	mA
Derating Linear From 50 $^\circ\text{C}$	0.4	mA/ $^\circ\text{C}$
Reverse Voltage	5	V
Operating Temperature Range	-40 $^\circ\text{C}$ to +85 $^\circ\text{C}$	
Storage Temperature Range	-40 $^\circ\text{C}$ to +100 $^\circ\text{C}$	
Lead Soldering Temperature[4mm(.157") From Body]	260 $^\circ\text{C}$ for 5 Seconds	

■ Electrical and optical characteristics($T_a=25\text{ }^\circ\text{C}$)

Parameter	Symbol	Min.	Typ.	Max.	Unit	Test Condition
Luminous Intensity	I_v		8000	-	mcd	$I_F=20\text{mA}$
Viewing Angle	$2\theta_{1/2}$	25	30	35	Deg	
Peak Emission Wavelength	λ_p	-	630	-	nm	
Dominant Wavelength	λ_d	618	625	630	nm	
Spectral Line Half-Width	$\Delta\lambda$	-	15	-	nm	
Forward Voltage	V_F	1.8	2.0	2.5	V	
Reverse Current	I_R			10	μA	$V_R=5\text{V}$

■ Typical Electrical Characteristics Curves

(25 ° c Ambient Temperature Unless Otherwise Noted)

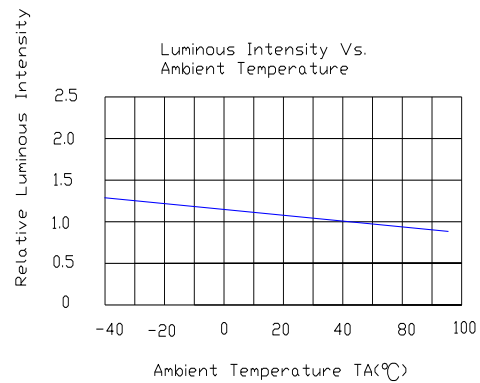
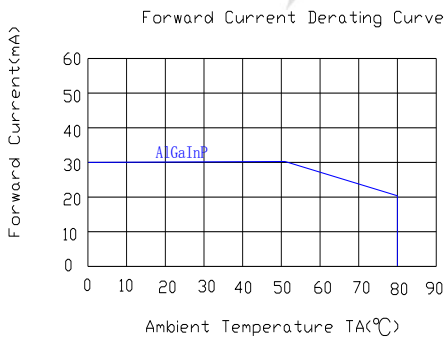
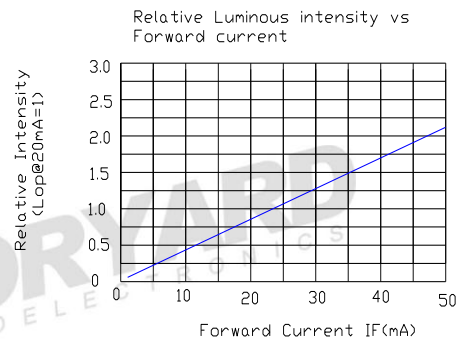
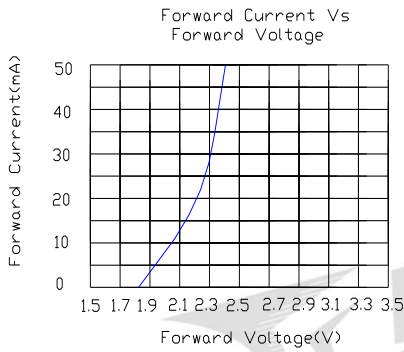
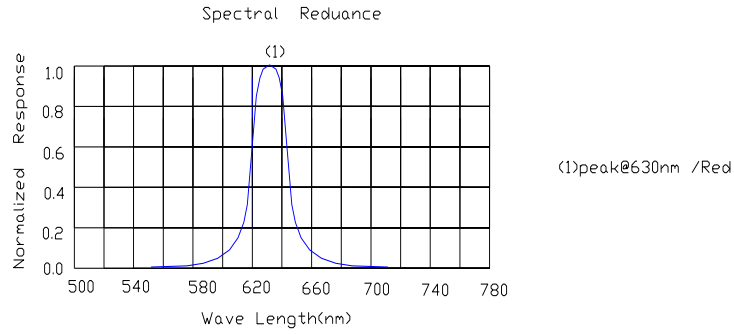

Radiation pattern.

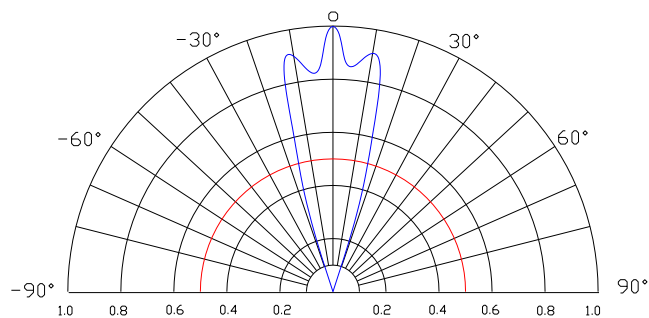

Model. No.	FYL-5014P URC1H-TL
Rev.	A201511

■ LAMP PACKING.

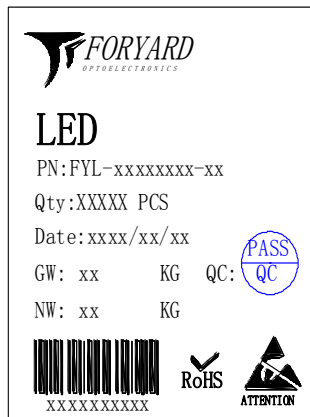
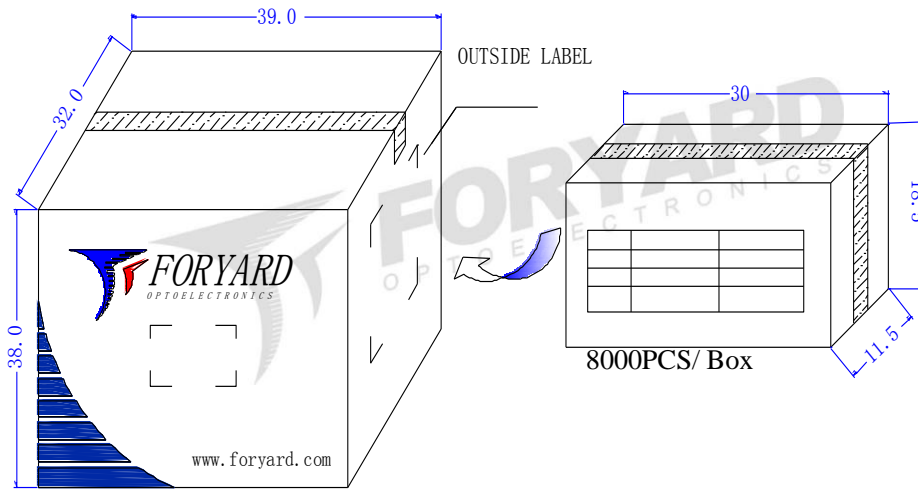
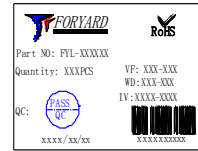
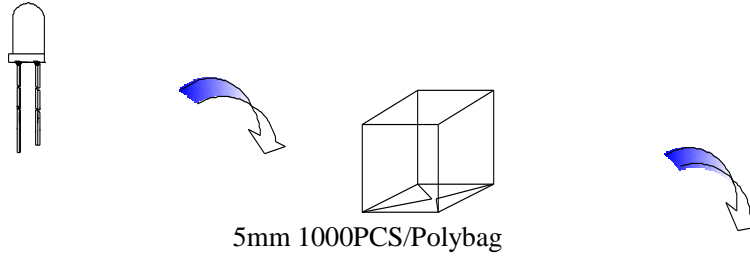

OUTSIDE LABEL