

# OMNETICS

CONNECTOR CORPORATION  
The World Leader in Nano Connection

## Polarized Nano Series

The Polarized Nano series is the most compact arrangement yet coming out of Omnetics Connector Corporation. The insulators are designed to hold one row of pins and one row of sockets. This configuration effectively polarizes the connector without the additional space required for guide pins.

The .025" (.64 mm) spacing and mil quality, gold plated contact system makes this one of the smallest Hi-Rel connectors on the market today. The Polarized nano series is available in 4, 6, 8, 10 and 12 position sizes.

Termination options include: Pre-Wiring, Straight tail, Horizontal SMT, and Vertical SMT.

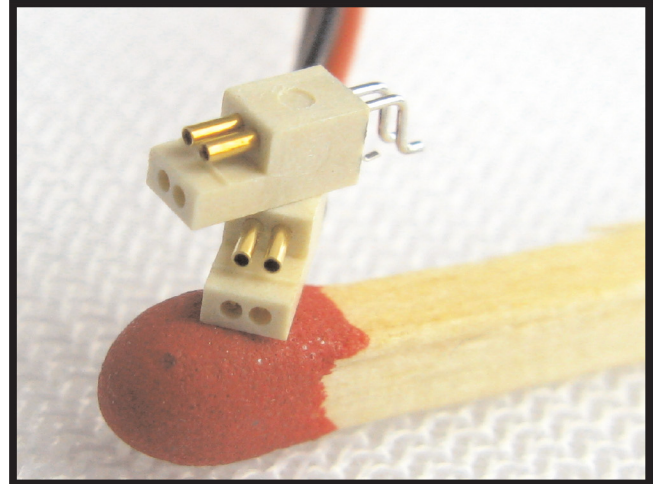

12 Position Polarized Nano Wired and SMT

Material Specs	Electrical Specs
<p><b>Insulator:</b> Thermoplastic Polyester, MIL-M-24519, Type GLCP-30F</p> <p><b>Sockets:</b> Copper Alloy per MIL-DTL-32139</p> <p><b>Pins:</b> Beryllium Copper per ASTM B194, Alloy C17200</p> <p><b>Contact Finish:</b> Gold plate per ASTM B488, Type II (Hard Gold), Code C, Class 1.27 Thickness = .00005" (1.27 µm)</p>	<p><b>Current:</b> 1 amp per contact</p> <p><b>Dielectric Withstanding Voltage:</b> 350 VAC RMS</p> <p><b>Insulation Resistance:</b> 5000 Meg ohms min @ 100 VDC</p> <p><b>Contact Resistance:</b> 25 milliohms (25 mv) max @ 1.0 amp</p> <p><b>Temperature:</b> -55°C to 125°C (200°C with HTE)</p> <p><b>Vibration:</b> 20 G's, no discontinuity greater than 10 nanoseconds</p> <p><b>Shock:</b> 100 G's, no discontinuity greater than 10 nanoseconds</p>

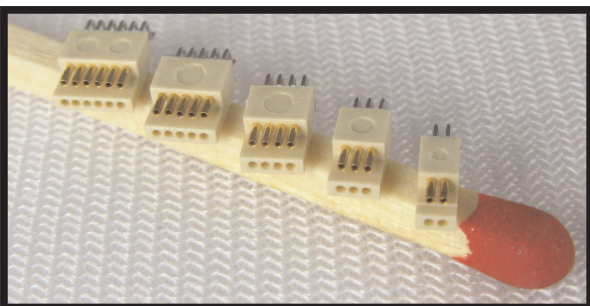

4, 6, 8, 10, 12 Position Polarized SMT Nano

### Omnetics Connector Corporation

7260 Commerce Circle East

Minneapolis, MN 55432

Phone: 763-572-0656

Fax: 763-572-3925

Web Site: [www.omnetics.com](http://www.omnetics.com)

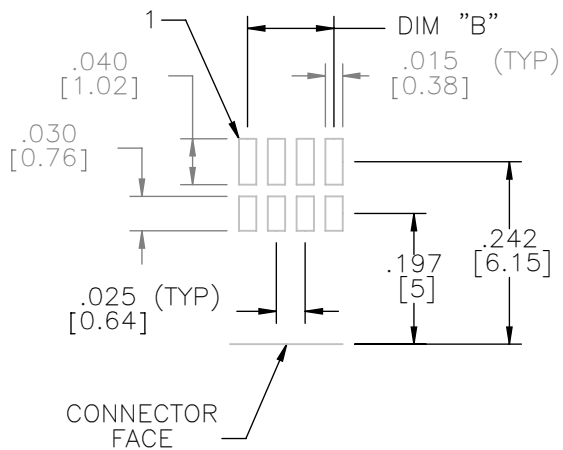

**HORIZONTAL SURFACE MOUNT TYPE AA**

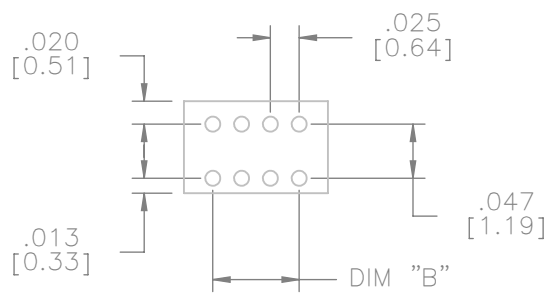

**STRAIGHT THROUGH HOLE TYPE DD**

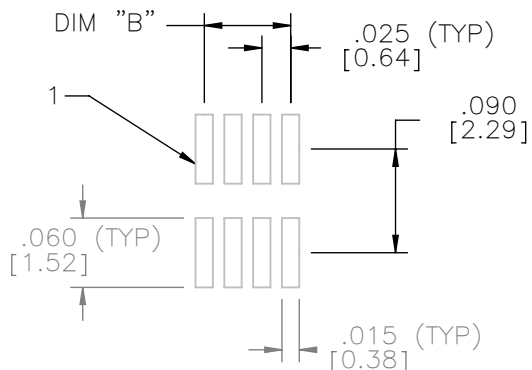

**VERTICAL MOUNT TYPE VV**

SOCKET #	COLOR
1, 11	BLACK
2, 12	BROWN
3	RED
4	ORANGE
5	YELLOW
6	GREEN
7	BLUE
8	VIOLET
9	GRAY
10	WHITE

**WIRE COLOR CODING**

Pad Layout Dimension (Dim "B")		
	Inches	[mm]
4 Contacts	= <u>.025</u>	= <u>0.64</u>
6 Contacts	= <u>.050</u>	= <u>1.27</u>
8 Contacts	= <u>.075</u>	= <u>1.91</u>
10 Contacts	= <u>.100</u>	= <u>2.54</u>
12 Contacts	= <u>.125</u>	= <u>3.18</u>

7260 COMMERCE CIRCLE EAST  
MINNEAPOLIS, MN 55432  
(763) 572-0656  
WWW.OMNETICS.COM



SERIES PZN  
POLARIZED NANO  
CONNECTOR

CAGE CODE:  
**61873**

DIMENSIONS IN  
INCHES ±.005  
[mm] ±.13

CAT-PZN-0935

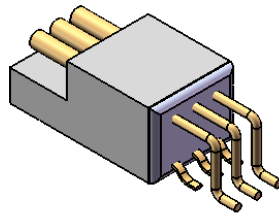
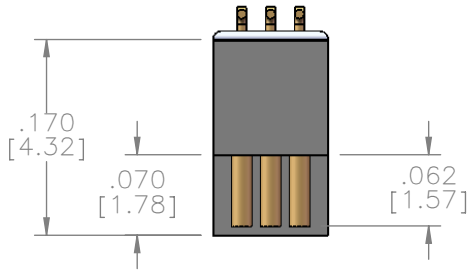

**HORIZONTAL SURFACE MOUNT TYPE AA**

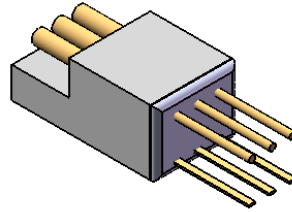
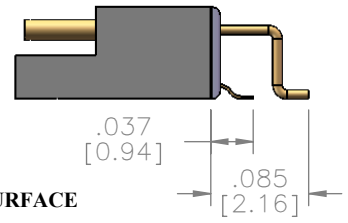

**STRAIGHT THROUGH HOLE TYPE DD**

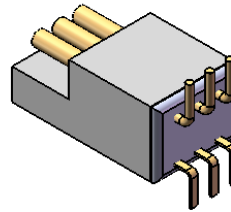
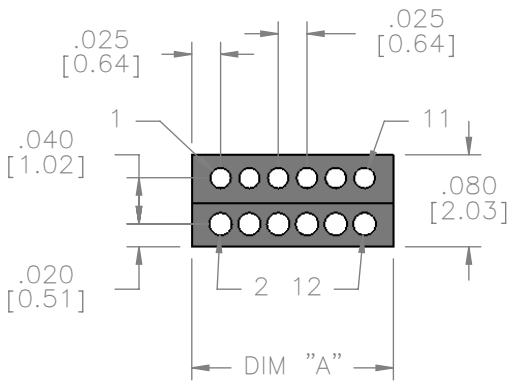
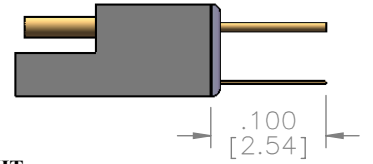

**VERTICAL MOUNT TYPE VV**

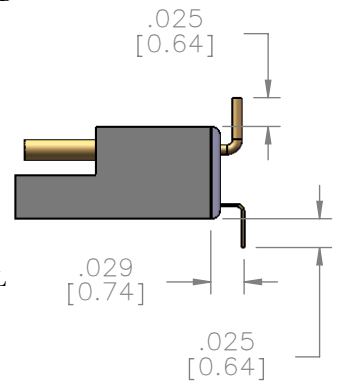

Connector Length (Dim "A")		
	Inches	[mm]
4 Contacts	= .075	= 1.91
6 Contacts	= .100	= 2.54
8 Contacts	= .125	= 3.18
10 Contacts	= .150	= 3.81
12 Contacts	= .175	= 4.45

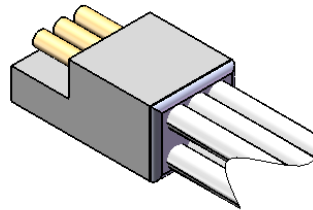

**DISCRETE LEADWIRE TYPE WD**

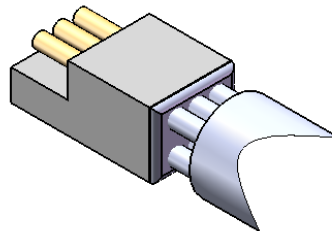
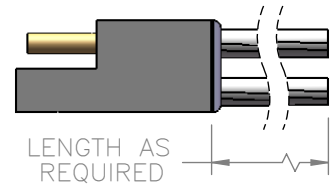

**CABLE TYPE WC**

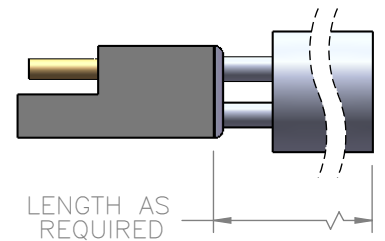

# Series PZN Nomenclature

## Examples

PZN-12-DD...Nano, 12 contacts, Straight Tails

PZN-12-WD-36.0-C-30...Nano, 12 contacts, 36.0" Color Coded 30 AWG Wire

[ ] - [ ] - [ ] - [ ] - [ ] - [ ]

(Each option separated by a hyphen)

<u>Series</u>	<u># Contacts</u>	<u>Termination</u>	<u>Wire Length</u>	<u>Common Options</u>	<u>Wire Gauge</u>
PZN	<b>04 up to 12</b> Note: Contact #s less than 10, use "0" first ex: 06, 09, etc	<u>PCB Tail Terminations</u> DD = Straight AA = SMT Horizontal VV = SMT Vertical <u>Wire Terminations</u> WC = Cable* WD = Discrete Leadwire XX = Other*	(Skip if not wire term) Length in Inches... including tenths example: 12.0 X.0 = Mixed Lengths	(List in this order) <u>C = Color Coded Wire</u> COLOR CODED: 1 & 11=Black 2 & 12=Brown 3= Red 4=Orange 5=Yellow 6=Green 7=Blue 8=Violet 9=Gray 10=White BK=All Black BL=All Blue WH=All White <u>RoHS=RoHS Compliant</u> HTE=High Temp Epoxy	<u>PTFE-NEMA HP3</u> 30=30 AWG 32=32 AWG 34=34 AWG SP=OTHER*
		<b>* Consult Factory</b>			

## Examples

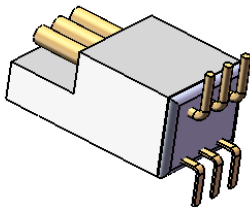

PZN-6-VV

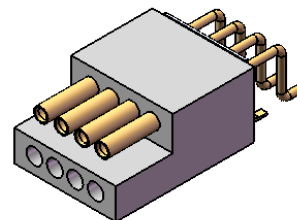

PZN-8-AA