

DC Power Connectors

L-KLS1-DC-5525 $\Phi 5.5 * \Phi 2.5 * 20.5$ Plug

Note:

- 1.PBT
- 2.Brass,Nickel,1um~2um
- 3.P-Bronze,Nickel,1um~2um
- Housing Material:Copper
- Insertion force:3-30N
- Rated load: 0.5A DC500V
- Product certification:ROHS
- Electrical life: 3000-5000 times

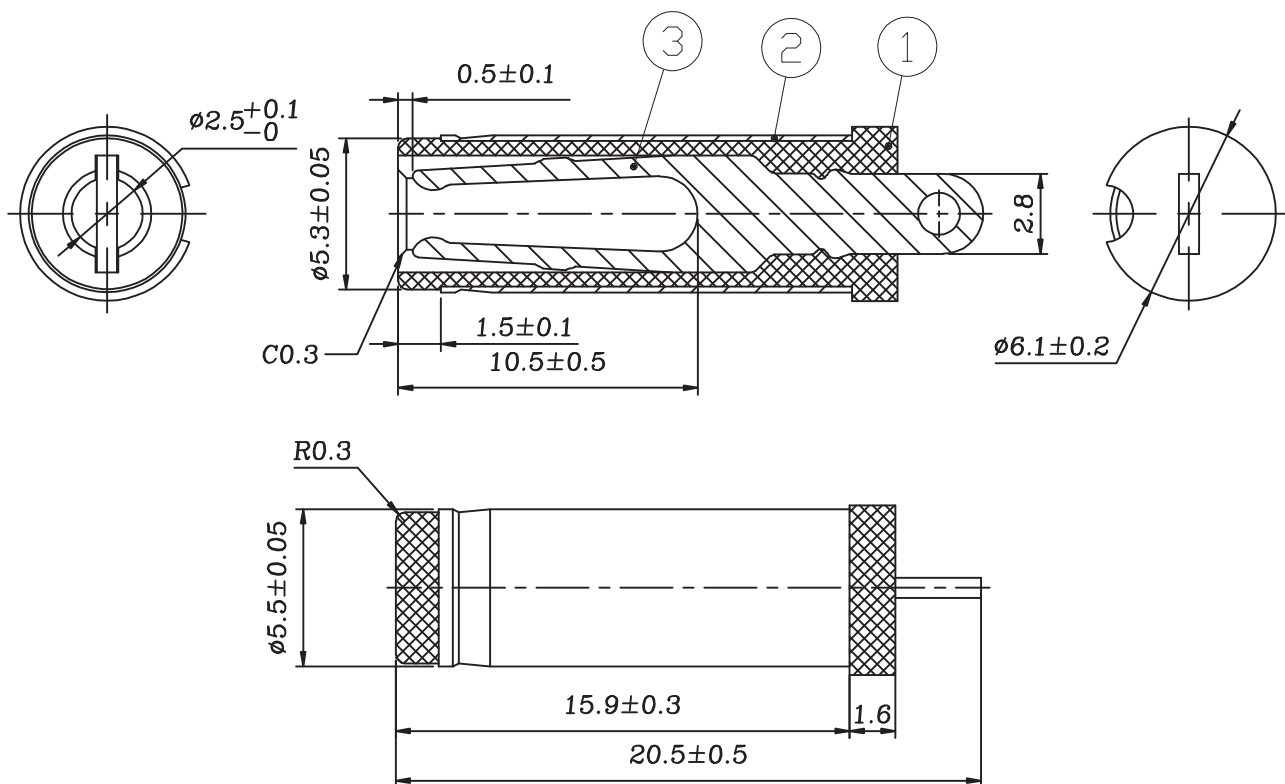

ORDER INFORMATION

Product NO.: L-KLS1-DC-5525

