

Specifications

Current Rating: 13A AC,DC
 Voltage Rating: 600V AC,DC
 Temperature Range: -55°C to +105°C
 Insulation Resistance: 1000MΩ Min
 Withstanding Voltage: 5000V AC/minute
 Material: Nylon 66, UL94V-0

ORDER INFORMATION

6 3 5 0 H - M 1

W

-

L

◎: Standard Recommend

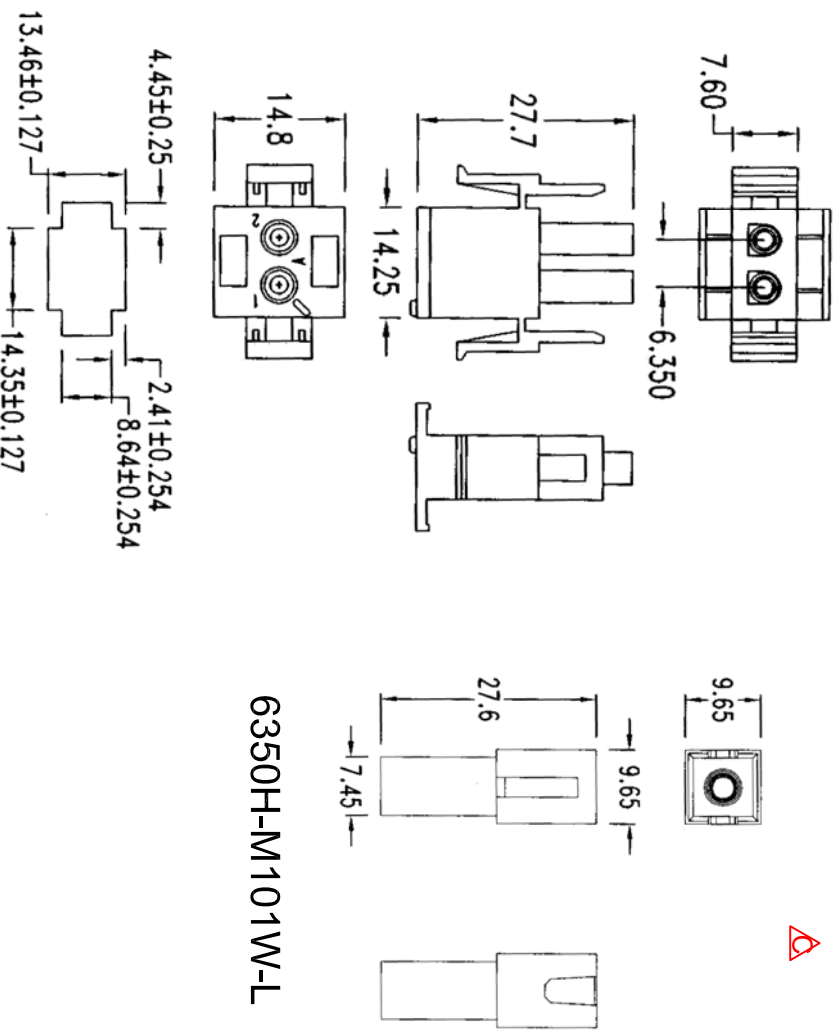
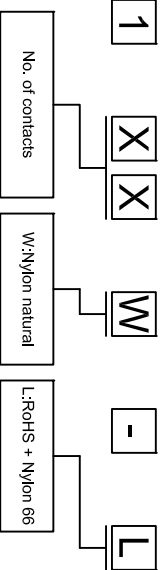

6350H-M102W-L

6350H-M101W-L

△	D	Add the No. of Contact: 06 ~ 10	2011/09/21
△	C	Add the No. of Contact: 01	2011/08/04
△	B	Revised the Part No.: 6350H-M1XXW-L(V2) -> 6350H-M1XXW-L	2010/08/27
AREA	REV.	DESCRIPTION	DATE

<p>Amitek Technology Co., Ltd. 緯德企業有限公司 Tel: 886-2-2258-9035 Fax: 886-2-2258-9035</p>		品名	6.35mm HOUSING				
		品號	6350H-M1XXW-L				
圖號	DRAWING NO.	6350H-M1XXW-L	版本	D	繪圖	DATE	
客戶品號	CUSTOMER P/N	.X ±0.30 .XX ±0.25	比例	SCALE	FREE	核對	
公差	TOLERANCE		單位	UNIT	mm	核准	
						核對	Sharron
						核准	James

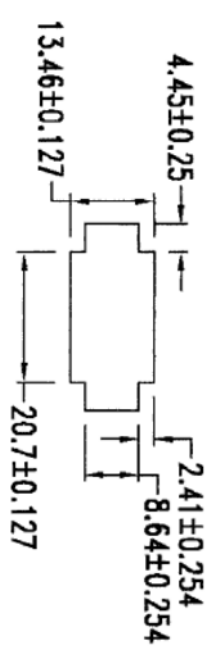
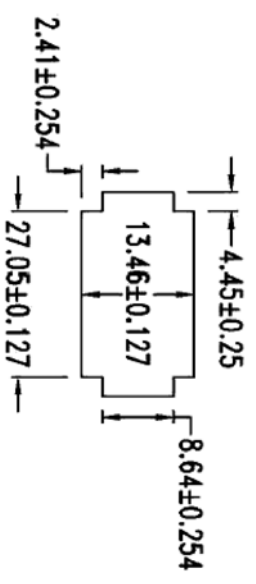
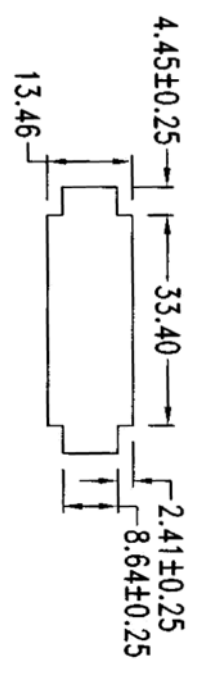
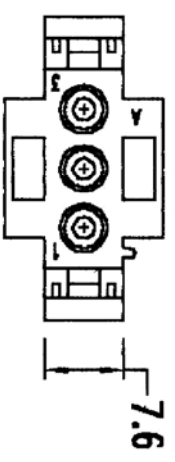
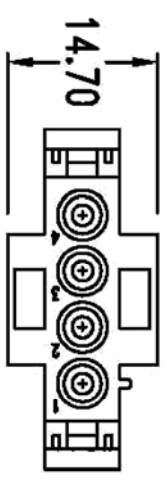
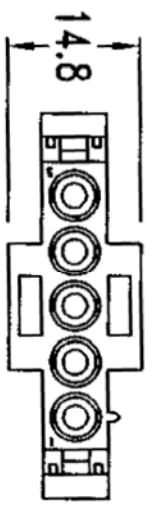
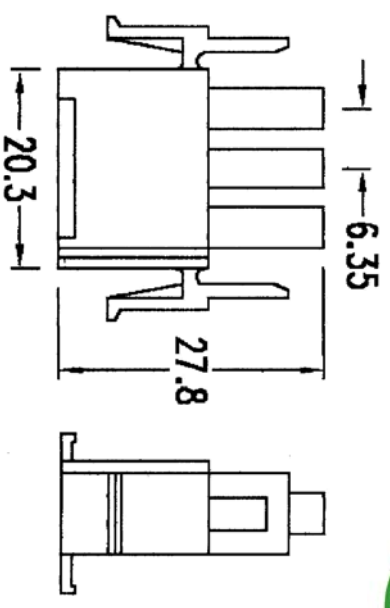
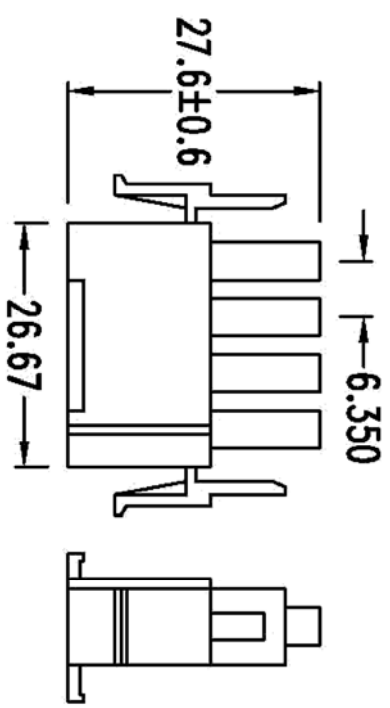
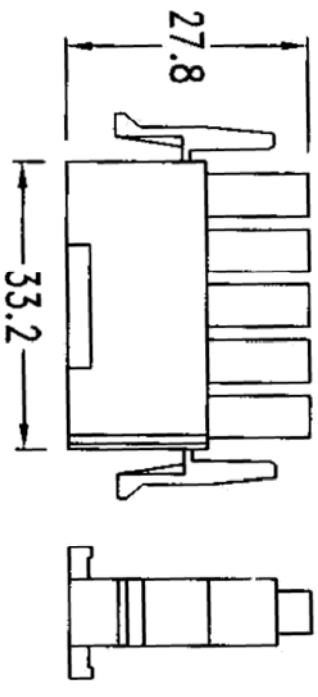
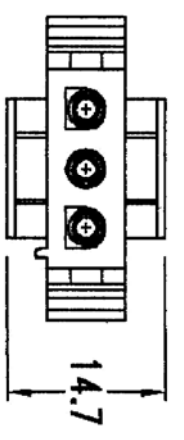
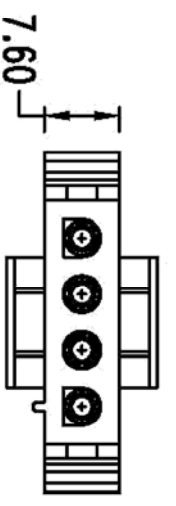
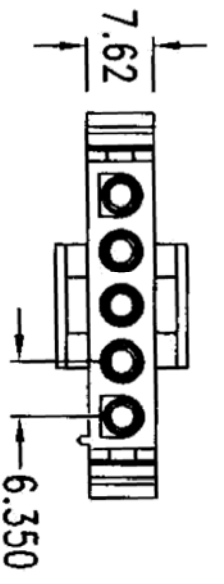

6350H-M105W-L

6350H-M104W-L

6350H-M103W-L

6.35mm HOUSING

△	D	Add the No. of Contact: 06 ~ 10	2011/09/21	Joe
△	C	Add the No. of Contact: 01	2011/08/04	Joe
△	B	Revised the Part No.: 6350H-M1XXW-L(V2) -> 6350H-M1XXW-L	2010/08/27	Joe
AREA	REV.	DESCRIPTION	DATE	

Amitek Technology Co., Ltd.
FAX: 86-25-2558-9035

品名	品號	圖號	客戶品號	公差	單位	核對	日期
TITLE	PART NO.	DRAWING NO.	CUSTOMER P/N	TOLERANCE	UNIT	CHECKED	DATE
6350H-M1XXW-L	6350H-M1XXW-L	6350H-M1XXW-L	6350H-M1XXW-L	.X ±0.30 .XX ±0.25	mm	Sharron	2010/04/07
6.35mm HOUSING						James	

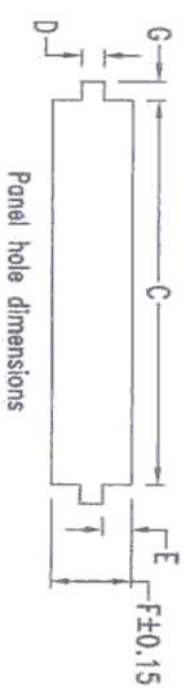
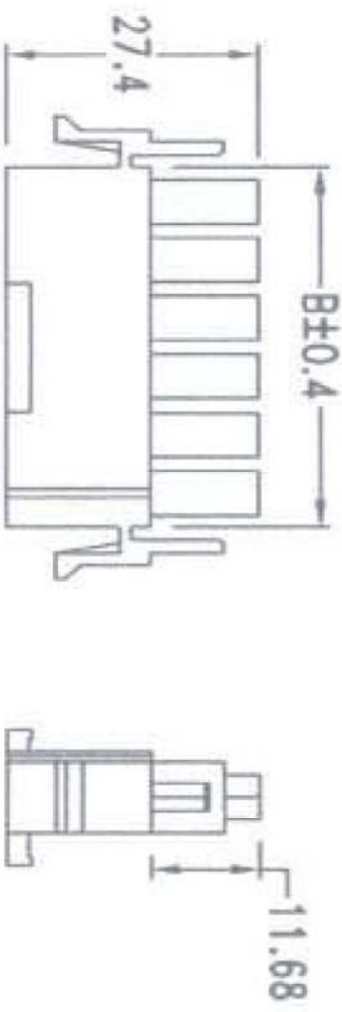
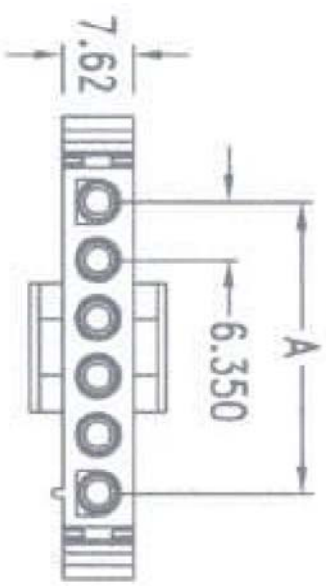

Circuits	Dim. A	Dim. B	Dim. C	Dim. D	Dim. E	Dim. F	Dim. G
6	31.75	39.37	39.80				
7	38.10	45.72	46.15				
8	44.45	52.07	52.50	3.90	4.80	13.50	3.20
9	50.80	58.42	58.85				
10	57.15	64.77	65.20				

AREA	REV.	DESCRIPTION	DATE
△	D	Add the No. of Contact: 06 ~ 10	2011/09/21 Joe
△	C	Add the No. of Contact: 01	2011/08/04 Joe
△	B	Revised the Part No.: 6350H-M1XXW-L(V2) -> 6350H-M1XXW-L	2010/08/27 Joe
		DESCRIPTION	

Amitek Technology Co., Ltd.
FAX: 86-2-2258-9035

品名 TITLE	品號 PART NO.	圖號 DRAWING NO.	客戶品號 CUSTOMER P/N	公差 TOLERANCE	單位 UNIT	日期 DATE	繪圖 DRAWN	核對 CHECKED	核准 APPROVED
6.35mm HOUSING	6350H-M1XXW-L	6350H-M1XXW-L		.X ±0.30 .XX ±0.25		2010/04/07	Sam	Sharron	James