

Thick Film Chip Resistor—CR Series

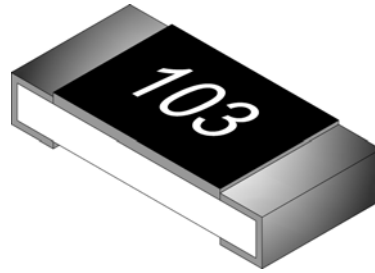

■ Construction

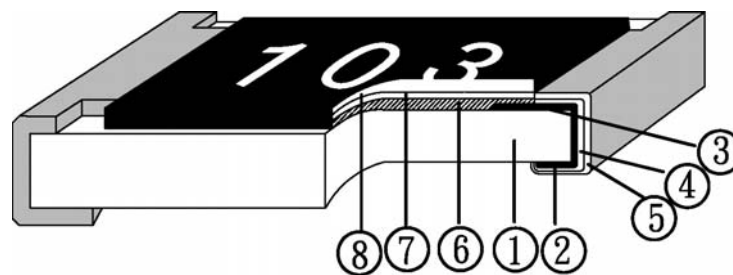

1	Alumina Substrate	5	External Electrode (Sn)
2	Bottom Electrode (Ag)	6	Resistor Layer (RuO ₂)
3	Top Electrode (Ag/Pd)	7	Primary Overcoat (Glass)
4	Barrier Layer (Ni)	8	Secondary Overcoat (Epoxy)

■ Application

- Entertainment: Stereo, TV tuners, Tape recorder
- Appliance: Air conditioner, Refrigerator
- Computer & relative products: Main board, PDA
- Communication equipment: Cell phone, Fax machine
- Power equipment: Power supply, Illumination equipment
- Measuring instrument: Electric meter, Navigation equipment

■ Features

- Small size and light weight
- Reduction of assembly costs and matching with placement machines
- Reliability, high quality and fast delivery

■ Low Ohm Chip Resistor

■ Type Dimension

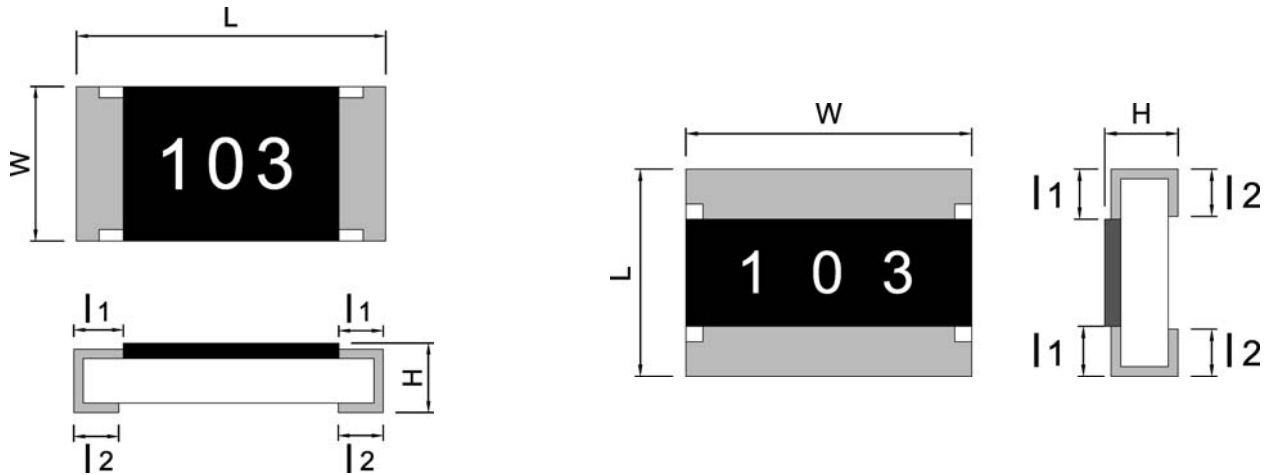

CR0402 / CR0603 / CR0805 / CR1206
/ CR1210 / CR1812 / CR2010 / CR2512

CR1218 / CR2030

■ Dimension

Unit: mm

TYPE	L	W	H	l ₁	l ₂
CR0402	1.00 ± 0.10	0.50 ± 0.05	0.30 ± 0.05	0.15 ± 0.10	0.20 ± 0.10
CR0603	1.60 ± 0.20	0.80 ± 0.15	0.40 ± 0.10	0.20 ± 0.10	0.30 ± 0.10
CR0805	2.00 ± 0.20	1.25 ± 0.15	0.50 ± 0.15	0.30 ± 0.15	0.40 ± 0.15
CR1206	3.05 ± 0.10	1.60 ± 0.20	0.55 ± 0.15	0.40 ± 0.20	0.50 ± 0.20
CR1210	3.05 ± 0.10	2.50 ± 0.20	0.55 ± 0.15	0.50 ± 0.20	0.50 ± 0.20
CR1812	4.50 ± 0.10	3.00 ± 0.10	0.55 ± 0.05	0.55 ± 0.20	0.70 ± 0.20
CR2010	5.00 ± 0.20	2.50 ± 0.20	0.55 ± 0.10	0.60 ± 0.20	0.60 ± 0.20
CR1218	3.10 ± 0.10	4.60 ± 0.10	0.55 ± 0.05	0.40 ± 0.20	0.50 ± 0.20
CR2512	6.30 ± 0.20	3.20 ± 0.20	0.55 ± 0.10	0.60 ± 0.20	0.60 ± 0.20
CR2030	5.10 ± 0.10	7.60 ± 0.10	0.60 ± 0.05	0.80 ± 0.20	0.80 ± 0.20

■ Standard Electrical Specifications

Item Type	Rated Power at 70°C	Rated Voltage	Max Working Voltage	Max Overload Voltage	T.C.R. (PPM/°C)	Resistance Range (mΩ)	Operating Temperature Range
						F(±1%) J±(5%)	
CR0402	0.063 W	0.17~0.25V	0.25 V	0.624 V	±800	470~990	-55°C ~ +155°C
CR0603	0.1 W	0.1~0.31V	0.31 V	0.775 V	±800	100~330	
					±600	331~510	
					±400	511~990	
CR0805	0.125 W	0.04~0.35V	0.35 V	0.875 V	±1000	10~50	
					±800	51~100	
					±600	101~330	
					±400	331~990	
CR1206	0.25 W	0.05~0.5V	0.5 V	1.25 V	±800	10~50	
					±600	51~100	
					±500	101~330	
					±400	331~990	
CR1210	0.33 W	0.06~0.57V	0.57 V	1.425 V	±800	10~50	
					±600	51~100	
					±500	101~330	
					±400	331~990	
CR1812	0.5 W	0.07~0.7V	0.7 V	1.75 V	±800	10~50	
					±600	51~100	
					±500	101~330	
					±400	331~990	
CR2010	0.5 W	0.07~0.7V	0.7 V	1.75 V	±800	10~50	
					±800	51~100	
					±600	101~330	
					±400	331~990	
CR1218	1 W	0.1~0.99V	0.99 V	2.475V	±800	10~50	
					±400	51~990	
CR2512	1 W	0.1~0.99V	0.99 V	2.475V	±800	10~50	
					±700	51~100	
					±500	101~330	
					±400	331~990	
CR2030	2 W	0.2~1.41V	1.41V	3.518V	±800	500~990	
					±1500	500~990	

High Power Electrical Specifications

Item Type	Rated Power at 70 °C	Rated Voltage	Max Working Voltage	Max Overload Voltage	T.C.R. (PPM/°C)	Resistance Range (mΩ)	Operating Temperature Range
						F(±1%) J±(5%)	
CR0603	0.125 W	0.11~0.35V	0.352 V	0.879 V	±800 ±600 ±400	100~330	-55°C ~ +155°C
						331~510	
						511~990	
CR0805	0.25 W	0.05~0.5V	0.497 V	1.244 V	±1000 ±800 ±600 ±400	10~50	
						51~100	
						101~330	
						331~990	
CR1206	0.5 W	0.07~0.7V	0.704 V	1.759 V	±800 ±600 ±500 ±400	10~50	
						51~100	
						101~330	
						331~990	
CR1210	0.66 W	0.08~0.81V	0.808 V	2.021 V	±800 ±600 ±500 ±400	10~50	
						51~100	
						101~330	
						331~990	
CR1812	1 W	0.1~0.99V	0.995 V	2.487 V	±800 ±600 ±500 ±400	10~50	
						51~100	
						101~330	
						331~990	
CR2010	1 W	0.1~0.99V	0.995 V	2.487 V	±800 ±800 ±600 ±400	10~50	
						51~100	
						101~330	
						331~990	
CR1218	2 W	0.14~1.41V	1.407 V	3.518 V	±800 ±400	10~50	
						51~990	
CR2512	2 W	0.14~1.41V	1.407 V	3.518 V	±800 ±700 ±500 ±400	10~50	
						51~100	
						101~330	
						331~990	
CR2030	3 W	0.24~1.72V	1.723 V	4.308 V	±800 ±1500	500~990	
						500~990	

Rated Resistance

Resistance	Code	0603 Code	Resistance	Code	0603 Code	Resistance	Code	0603 Code	Resistance	Code	0603 Code	Resistance	Code	0603 Code
10mΩ	R010	010	65mΩ	R065	065	0.12Ω	R120	R12	0.27Ω	R270	R27	0.56Ω	R560	R56
15mΩ	R015	015	68mΩ	R068	068	0.13Ω	R130	R13	0.30Ω	R300	R30	0.60Ω	R600	R60
20mΩ	R020	020	70mΩ	R070	070	0.15Ω	R150	R15	0.33Ω	R330	R33	0.65Ω	R650	R65
30mΩ	R030	030	75mΩ	R075	075	0.16Ω	R160	R16	0.36Ω	R360	R36	0.68Ω	R680	R68
40mΩ	R040	040	80mΩ	R080	080	0.18Ω	R180	R18	0.40Ω	R400	R40	0.70Ω	R700	R70
50mΩ	R050	050	90mΩ	R090	090	0.20Ω	R200	R20	0.43Ω	R430	R43	0.75Ω	R750	R75
56mΩ	R056	056	0.10Ω	R100	R10	0.22Ω	R220	R22	0.47Ω	R470	R47	0.80Ω	R800	R80
60mΩ	R060	060	0.11Ω	R110	R11	0.25Ω	R250	R25	0.50Ω	R500	R50	0.90Ω	R900	R90

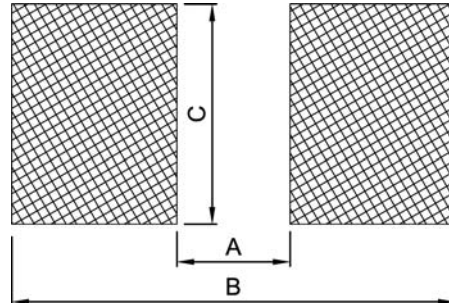
Recommend Land Pattern Design (For Reflow Soldering)

Dimension

Unit: mm

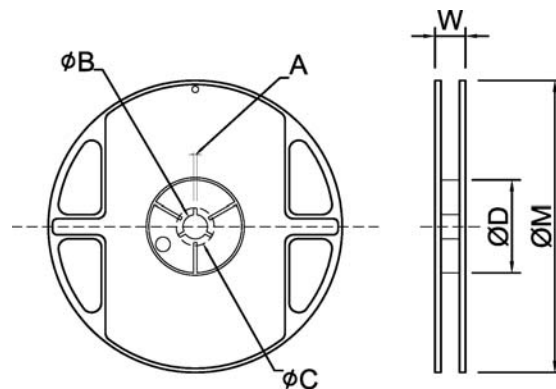
Type Item	CR0201	CR0402	CR0603	CR0805	CR1206	CR1210	CR1812	CR2010	CR1218	CR2512	CR2030
A	0.25	0.60	0.80	1.30	2.20	2.00	3.11	3.80	2.04	4.90	3.50
B	1.10	1.60	2.40	2.90	4.20	4.40	5.91	6.60	4.24	8.10	7.50
C	0.32	0.70	1.00	1.40	1.70	2.70	3.00	2.70	4.50	3.40	7.80

Packaging

Dimension

Unit: mm

TYPE	SIZE	A	ϕB	ϕC	ϕD	W	ϕM
CR0201 CR0402	7" 10K/Reel	2.0±0.5	13.5±1.0	21±1.0	60±1.0	11.5±2.0	178±2.0
CR0603 CR0805 CR1206	7" 5K/Reel	2.0±0.5	13.5±1.0	21±1.0	60±1.0	11.5±2.0	178±2.0
	10" 10K/Reel	2.0±0.5	13.5±1.0	21±1.0	100±1.0	11.5±2.0	254±2.0
	13" 20K/Reel	2.0±0.5	13.5±1.0	21±1.0	100±1.0	11.5±2.0	330±2.0
CR1210	7" 5K/Reel	2.0±0.5	13.5±1.0	21±1.0	60±1.0	11.5±2.0	178±2.0
CR2010 CR2512 CR1812 CR1218	7" 4K/Reel	2.0±0.5	13.5±1.0	21±1.0	60±1.0	16.0±2.0	178±2.0
CR2030	7" 1K/Reel	2.0±0.5	13.5±1.0	21±1.0	60±1.0	19.0±2.0	178±2.0

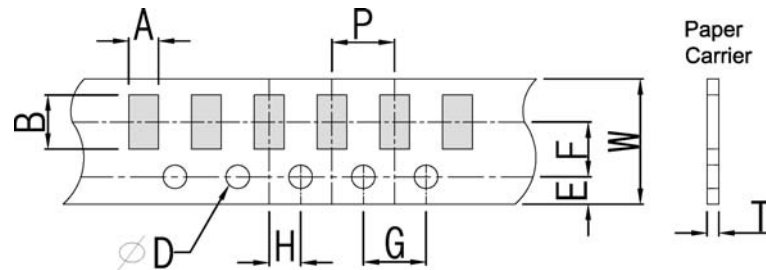
■ Tapping Specification



■ Dimension

Unit: mm

Packaging	Type	A	B	W	E	F	G	H	T	ϕD	P
Paper Type	CR0201	0.45±0.10	0.75±0.10	8.0±0.20	1.75±0.10	3.5±0.05	4.0±0.10	2.0±0.05	0.35±0.10	1.50±0.10	2.0±0.1
	CR0402	0.70±0.10	1.20±0.10	8.0±0.20	1.75±0.10	3.5±0.05	4.0±0.10	2.0±0.05	0.45±0.10	1.50±0.10	
	CR0603	1.05±0.20	1.80±0.20	8.0±0.20	1.75±0.10	3.5±0.05	4.0±0.10	2.0±0.05	0.60±0.10	1.50±0.10	4.0±0.1
	CR0805	1.55±0.20	2.30±0.20	8.0±0.20	1.75±0.10	3.5±0.05	4.0±0.10	2.0±0.05	0.75±0.10	1.50±0.10	
	CR1206	1.90±0.20	3.50±0.20	8.0±0.20	1.75±0.10	3.5±0.05	4.0±0.10	2.0±0.05	0.75±0.10	1.50±0.10	
	CR1210	2.85±0.20	3.50±0.20	8.0±0.20	1.75±0.10	3.5±0.05	4.0±0.10	2.0±0.05	0.75±0.10	1.50±0.10	

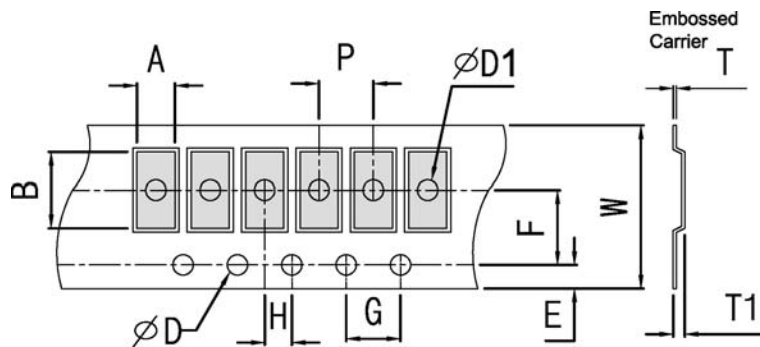

■ Dimension

Unit: mm

Packaging	Type	A	B	W	E	F	G	H	T	ϕD	$\psi D1$	T1	P
Embossed Type	CR2010	2.80±0.20	5.60±0.20	12±0.10	1.75±0.10	5.5±0.05	4.0±0.10	2.0±0.05	0.23±0.10	1.50±0.10	1.50±0.10	0.85±0.15	4.0±0.1
	CR2512	3.40±0.20	6.70±0.20	12±0.10	1.75±0.10	5.5±0.05	4.0±0.10	2.0±0.05	0.23±0.10	1.50±0.10	1.50±0.10	0.85±0.15	
	CR1812	3.30±0.20	4.60±0.20	12±0.10	1.75±0.10	5.5±0.05	4.0±0.10	2.0±0.05	0.23±0.10	1.50±0.10	1.50±0.10	0.85±0.15	
	CR1218	3.30±0.20	4.60±0.20	12±0.10	1.75±0.10	5.5±0.05	4.0±0.10	2.0±0.05	0.23±0.10	1.50±0.10	1.50±0.10	0.85±0.15	
	CR2030	5.50±0.20	7.90±0.20	16±0.10	1.75±0.10	7.5±0.05	4.0±0.10	2.0±0.05	0.25±0.10	1.50±0.10	1.50±0.10	0.85±0.15	8.0±0.2

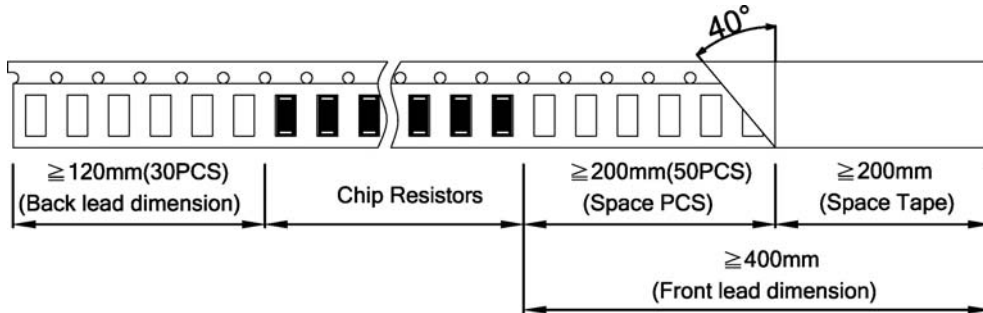
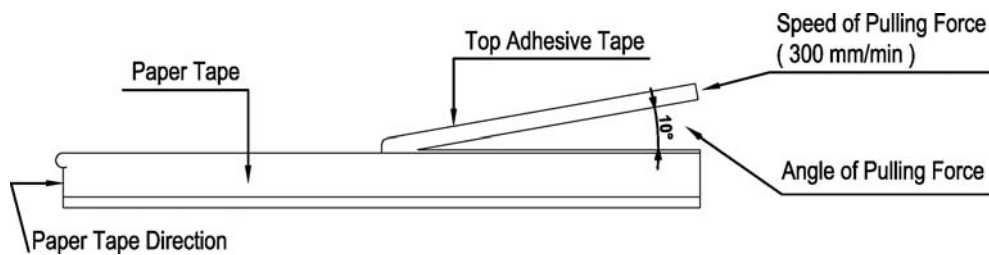
■ Packing Material Data/Storage Data
■ Front & Back Lead Dimension

■ Top Adhesive Peel Off Strength : 10~70g

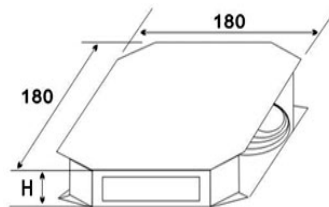
■ Package

Inner Box Size	
Reel	Size H(mm)
1	13
2	24
3	36
5	60
10	113

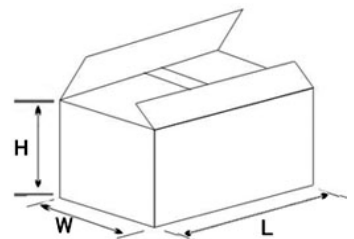

External Box Size			
Contain (Kpcs)	Length (mm)	Width (mm)	Height (mm)
25K	180	180	60
50K	180	180	110
150K	430	200	200
300K	400	400	200

■ Storage Data :

Storage time at the environment temp: $25\pm 5^\circ\text{C}$ & humidity: $50\pm 20\%$ is valid for one year from the date of delivery.

■ Parts Number Explanation

■ Example:

CR	0603	J	10R	P	05
Product Type	Size (Inch)	Resistor Tolerance	Resistors Value	Package	Quantity
	0201 0402 0603 0805 1206 1210 1812 2010 1218 2512 2030	B : $\pm 0.1\%$ C : $\pm 0.25\%$ D : $\pm 0.5\%$ F : $\pm 1\%$ G : $\pm 2\%$ J : $\pm 5\%$ K : $\pm 10\%$ L : $\pm 15\%$ M : $\pm 20\%$ N : $\pm 30\%$		P、Q : Paper Taping E : Embossed Taping D : Packed in a Bag	01 : 1000PCS 02 : 2000PCS 04 : 4000PCS 05 : 5000PCS 10 : 10000PCS 20 : 20000PCS 40 : 40000PCS 50 : 50000PCS

■ Test Procedures and Requirements

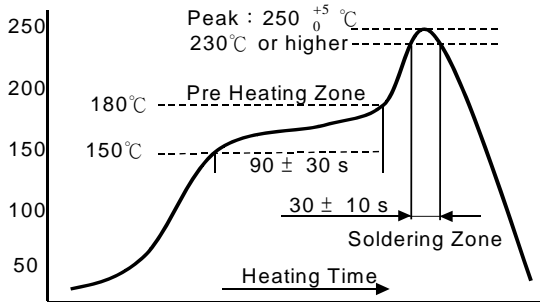
Test Item	Test Method	Procedure	Requirements
Temperature Coefficient of Resistance (T.C.R)	JIS C 5201-1 clause 4.8	-55°C ~+155°C, 20°C is the reference temperature	Refer to Ratings
Short Time Overload	JIS C 5201-1 clause 4.13	General : 2.5 times RCWV or Max. Overload voltage for 5 seconds. High Power : 2.5 times RCWV or Max. Overload voltage for 2 seconds.	±1 : ±(1.0%+0.05 Ω) ±5 : ±(2.0%+0.1 Ω)
IR Reflow	Sony SS-00254	 <p>Peak : 250⁺⁵₀ °C 230°C or higher</p> <p>180°C --- Pre Heating Zone</p> <p>150°C --- 90 ± 30 s</p> <p>30 ± 10 s --- Soldering Zone</p> <p>Heating Time</p>	±1 : ±(1.0%+0.05 Ω) ±5 : ±(1.0%+0.05 Ω)
Leaching	Sony SS-00254-9	260±5°C for 30 seconds.	>95% Coverage
Soldering Heat	JIS C 5201-1 clause 4.18	260±5°C for 10 seconds.	±1 : ±(0.5%+0.05 Ω) ±5 : ±(1.0%+0.05 Ω)
Temperature Cycling	JIS C 5201-1 clause 4.19	-55°C to +155°C, 5 cycles	0.1%、0.5%、1% : ±(0.5%+0.05 Ω) 2%、5% : ±(1.0%+0.10 Ω)
Electric Iron	Sony SS-00254-5	Preheating temperature : 350±5°C Electric iron preheating time : 3+1/-0 sec	±1 : ±(1.0%+0.05 Ω) ±5 : ±(1.0%+0.05 Ω)
Resistance to Solvent	JIS C 5201-1 clause 4.29	The tested resistor be immersed into isopropyl alcohol of 20~25°C for 60 secs. Then the resistor is left in the room for 48 hrs.	±1 : ±(0.5%+0.05 Ω) ±5 : ±(0.5%+0.05 Ω)
Load Life in Humidity	JIS C 5201-1 clause 4.24	40±2°C, 90~95% R.H. or Max. working voltage for 1000 hrs with 1.5 hrs "ON" and 0.5 hr "OFF" .	0.1%、0.5%、1% : ±(0.5%+0.05 Ω) 2%、5% : ±(2.0%+0.05 Ω)
Load Life (Endurance)	JIS C 5201-1 clause 4.25	70±2°C, or Max. working voltage for 1000 hrs with 1.5 hrs "ON" and 0.5 hr "OFF" .	0.1%、0.5%、1% : ±(1.0%+0.05 Ω) 2%、5% : ±(3.0%+0.10 Ω)
Terminal Bending Strength	JIS C 5201-1 clause 4.33	Bending once for 5 seconds D : CR Series 0402、0603、0805=5mm CR Series 1206、1210、1812=3mm CR Series 1218、2010、2512、2030=2mm	±1 : ±(1.0%+0.05 Ω) ±5 : ±(1.0%+0.05 Ω)
Insulation Resistance	JIS C 5201-1 clause 4.6	Max. Overload voltage for 1 minute.	≥ 10G Ω

■ Performance Characteristics

■ Power Derating Curve

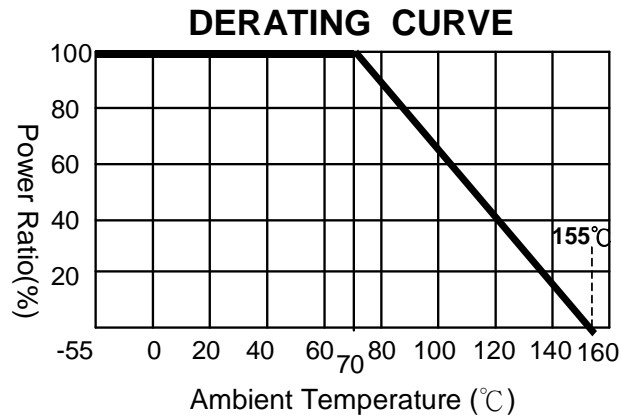

Power rating or current rating is in the case based on continuous full-load at ambient temperature of 70°C. For operation at ambient temperature in excess of 70°C, the load should be derated in accordance with figure of derating Curve.

■ Voltage Rating or Current Rating

Resistance Range: $\geq 1 \Omega$

Rated Voltage: The resistor shall have a DC continuous working voltage or a RMS AC continuous working voltage at commercial-line frequency and wave form corresponding to the power rating, as determined formula as following:

$$E = \sqrt{P \times R}$$

E=Rated voltage(V)
 P=Power rating(W)
 R=Nominal resistance(Ω)

■ Operation and Storage Temperature

	MIN	MAX
Operation temperature	-55°C	70°C
Storage temperature	20°C	30°C
Storage humidity	30%	70%

■ Soldering Profile

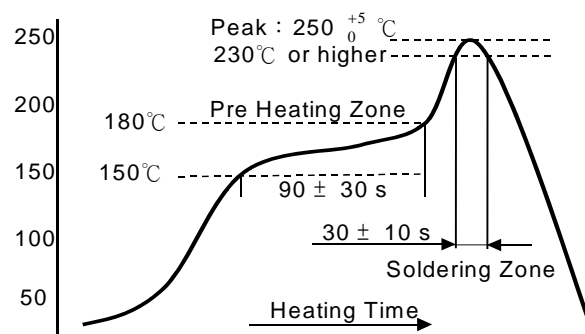

■ Equipments Applicable:

Our company's products are produced under low temperature processing applicable to IR reflow surface mounting devices. It is comparatively not applicable to wave soldering which will possibly cause the risk ablating the element protection layer and the front conductor and cause the drift of the resistance value and ablation of the markings.

■ Product Testing Method:

Our products are tested with our company's tapping & testing equipments by using four-feet probe to touch at the back of both electrodes. Supposed different testing points or methods are requested, please advise beforehand and customized-made production is available.

■ 0603 E-96 Multiplier Code

Code	A	B	C	D	E	F	G	H	X	Y	Z
Multiplier	10^0	10^1	10^2	10^3	10^4	10^5	10^6	10^7	10^{-1}	10^{-2}	10^{-3}

CODING FORMULA

XX X
 ↑ ↙
 Resistance Code Multiplier Code

Example: $10.2K\Omega = 102 \times 10^2\Omega = 02C$
 $33.2\Omega = 332 \times 10^{-1}\Omega = 51X$

■ 0603 Standard E-96 Values and 0603 Resistance Codes

R-Value	100	102	105	107	110	113	115	118	121	124	127	130	133	137	140	143	147	150	154	158	162	165	169	174
Code	01	02	03	04	05	06	07	08	09	10	11	12	13	14	15	16	17	18	19	20	21	22	23	24
R-Value	178	182	187	191	196	200	205	210	215	221	226	232	237	243	249	255	261	267	274	280	287	294	301	309
Code	25	26	27	28	29	30	31	32	33	34	35	36	37	38	39	40	41	42	43	44	45	46	47	48
R-Value	316	324	332	340	348	357	365	374	383	392	402	412	422	432	442	453	464	475	487	499	511	523	536	549
Code	49	50	51	52	53	54	55	56	57	58	59	60	61	62	63	64	65	66	67	68	69	70	71	72
R-Value	562	576	590	604	619	634	649	665	681	698	715	732	750	768	787	806	825	845	866	887	909	931	953	976
Code	73	74	75	76	77	78	79	80	81	82	83	84	85	86	87	88	89	90	91	92	93	94	95	96

Standard Resistance Values in a Decade

Marking code:

- TYPE : CR Series
- 1%: marking code, please refer to E96 and E24 data form as below
 Ex: 120K, The marking code is 1203 in E24
 121K, The marking code is 1213 in E96
- 5%: marking code, please refer to E24 data form as below
 Ex: 120K, The marking code is 124 in E24
- Note: 0402 series resistor has no marking code.
- Type: 0603 1% marking code, please refer to E-96 multiplier code.

E192	E96	E48	E192	E96	E48	E192	E96	E48	E192	E96	E48	E192	E96	E48	
100	100	100	169	169	169	287	287	287	487	487	487	825	825	825	
101			172			291			493			835			
102	102		174	174		294	294		499	499		845	845		
104			176			298			505			856			
105	105	105	178	178	178	301	301	301	511	511	511	866	866	866	
106			180			305			517			876			
107	107		182	182		309	309		523	523		887	887		
109			184			312			530			898			
110	110	110	187	187	187	316	316	316	536	536	536	909	909	909	
111			189			320			542			920			
113	113		191	191		324	324		549	549		931	931		
114			193			328			556			942			
115	115	115	196	196	196	332	332	332	562	562	562	953	953	953	
117			198			336			569			965			
118	118		200	200		340	340		576	576		976	976		
120			203			344			583			988			
121	121	121	205	205	205	348	348	348	590	590	590				
123			208			352			597						
124	124		210	210		357	357		604	604		E24	E12	E6	E3
126			213			361			612			10	10	10	10
127	127	127	215	215	215	365	365	365	619	619	619	11			
129			218			370			626			12	12		
130	130		221	221		374	374		634	634		13			
132			223			379			642			15	15	15	
133	133	133	226	226	226	383	383	383	649	649	649	16			
135			229			388			657			18	18		
137	137		232	232		392	392		665	665		20			
138			234			397			673			22	22	22	22
140	140	140	237	237	237	402	402	402	681	681	681	24			
142			240			407			690			27	27		
143	143		243	243		412	412		698	698		30			
145			246			417			706			33	33	33	
147	147	147	249	249	249	422	422	422	715	715	715	36			
149			252			427			723			39	39		
150	150		255	255		432	432		732	732		43			
152			258			437			741			47	47	47	47
154	154	154	261	261	261	442	442	442	750	750	750	51			
156			264			448			759			56	56		
158	158		267	267		453	453		768	768		62			
160			271			459			777			68	68	68	
162	162	162	274	274	274	464	464	464	787	787	787	75			
164			277			470			796			82	82		
165	165		280	280		475	475		806	806		91			
167			284			481			816						

According to IEC publication 63