

APPROVAL SHEET

MULTILAYER CERAMIC CAPACITORS

Microwave Series (RF)

01005 to 0805 Sizes (6.3V to 500V)

NP0 Dielectric

RoHS Compliance

*Contents in this sheet are subject to change without prior notice.

1. INTRODUCTION

MLCC consists of a conducting material and electrodes. To manufacture a chip-type SMT and achieve miniaturization, high density and high efficiency, ceramic condensers are used.

WTC RF series MLCC is used at high frequencies generally have a small temperature coefficient of capacitance, typical within the $\pm 30\text{ppm}/^\circ\text{C}$ required for NP0 (COG) classification and have excellent conductivity internal electrode. Thus, WTC RF series MLCC will be with the feature of low ESR and high Q characteristics.

2. FEATURES

- High Q and low ESR performance at high frequency.
- Ultra low capacitance to 0.1pF.
- Can offer high precision tolerance to $\pm 0.05\text{pF}$.
- Quality improvement of telephone calls for low power loss and better performance.

3. APPLICATIONS

- Telecommunication products & equipments: Mobile phone, WLAN, Base station.
- RF module: Power amplifier, VCO.
- Tuners.

4. HOW TO ORDER

<u>RF</u>	<u>15</u>	<u>N</u>	<u>100</u>	<u>J</u>	<u>500</u>	<u>C</u>	<u>I</u>
<u>Series</u>	<u>Size</u>	<u>Dielectric</u>	<u>Capacitance</u>	<u>Tolerance</u>	<u>Rated voltage</u>	<u>Termination</u>	<u>Packaging</u>
RF=Ultra High Q & Low ESR	02=01005(0402) 03=0201 (0603) 15=0402 (1005) 18=0603 (1608) 21=0805 (2012)	N=NP0	Two significant digits followed by no. of zeros. And R is in place of decimal point. eg.: 0R5=0.5pF 1R0=1.0pF 100=10x10 ⁰ =10pF	A= $\pm 0.05\text{pF}$ B= $\pm 0.1\text{pF}$ C= $\pm 0.25\text{pF}$ D= $\pm 0.5\text{pF}$ F= $\pm 1\%$ G= $\pm 2\%$ J= $\pm 5\%$	Two significant digits followed by no. of zeros. And R is in place of decimal point. 6R3=6.3 VDC 100=10 VDC 250=25 VDC 500=50 VDC 101=100 VDC 251=250 VDC 501=500 VDC	C=Cu/Ni/Sn	T=7" reeled G= 13" reeled

5. EXTERNAL DIMENSIONS

Size Inch (mm)	L (mm)	W (mm)	T (mm)/Symbol	Remark	M _B (mm)
01005 (0402)	0.40±0.02	0.20±0.02	0.20±0.02	V #	0.10±0.03
0201 (0603)	0.60±0.03	0.30±0.03	0.30±0.03	L #	0.15±0.05
0402 (1005)	1.00±0.05	0.50±0.05	0.50±0.05	N #	0.25±0.05/-0.10
0603 (1608)	1.60±0.10	0.80±0.10	0.80±0.07	S	0.40±0.15
	1.60 +0.15/-0.10	0.80 +0.15/-0.10	0.50±0.10	H	
0805 (2012)	2.00±0.15	1.25±0.10	0.60±0.10	A	0.50±0.20
	2.00±0.20	1.25±0.20	0.85±0.10	T	

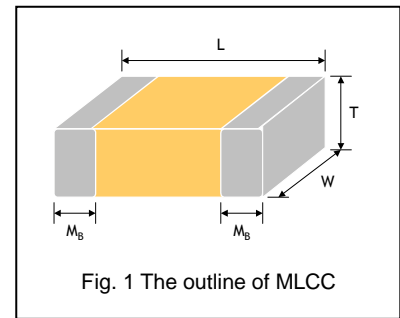

Reflow soldering only is recommended.

6. GENERAL ELECTRICAL DATA

Dielectric	NPO
Size	01005, 0201, 0402, 0603, 0805
Capacitance*	0.1pF to 100pF
Capacitance tolerance	Cap≤5pF: A (±0.05pF), B (±0.1pF), C (±0.25pF) 5pF<Cap<10pF: B (±0.1pF), C (±0.25pF), D (±0.5pF) Cap≥10pF: F (±1%), G (±2%), J (±5%)
Rated voltage (WVDC)	6.3V, 10V, 25V, 50V, 100V, 250V, 500V
Q*	01005, 0201, 0402/25V~50V: Cap<30pF:Q≥400+20C; Cap≥30pF:Q≥1000 0402/100V~200V, 0603, 0805, 0505: Cap<30pF:Q≥800+20C; Cap≥30pF:Q≥1400
Insulation resistance at U _r	≥10GΩ or RxC≥100Ω·F whichever is smaller.
Operating temperature	-55 to +125°C
Capacitance change	±30ppm/°C; 0201Cap≥22pF, ±60ppm/°C
Termination	Ni/Sn (lead-free termination)

* Measured at the conditions of 25°C ambient temperature and 30~70% related humidity.

Apply 1.0±0.2Vrms, 1.0MHz±10% for Cap≤1000pF and 1.0±0.2Vrms, 1.0kHz±10% for Cap>1000pF.

7. PACKAGING DIMENSION AND QUANTITY

Size	Thickness (mm)/Symbol		Paper tape	
			7" reel	13" reel
01005 (0402)	0.20±0.02	V	20,000	-
0201 (0603)	0.30±0.03	L	15,000	70,000
0402 (1005)	0.50±0.05	N	10,000	50,000
0603 (1608)	0.80±0.07	S	4,000	15,000
	0.50±0.10	H	4,000	-
0805 (2012)	0.60±0.10	A	4,000	15,000
	0.85±0.10	T	4,000	15,000

Unit: pieces

8. CAPACITANCE RANGE

DIELECTRIC		NP0		Tolerance
SIZE		01005		
RATED VOLTAGE (VDC)		16	25	
Capacitance	0.2pF (0R2)	V	V	A, B
	0.3pF (0R3)	V	V	A, B
	0.4pF (0R4)	V	V	A, B
	0.5pF (0R5)	V	V	A, B, C
	0.6pF (0R6)	V	V	A, B, C
	0.7pF (0R7)	V	V	A, B, C
	0.8pF (0R8)	V	V	A, B, C
	0.9pF (0R9)	V	V	A, B, C
	1.0pF (1R0)	V	V	A, B, C
	1.2pF (1R2)	V	V	A, B, C
	1.5pF (1R5)	V	V	A, B, C
	1.8pF (1R8)	V	V	A, B, C
	2.0pF (2R0)	V	V	A, B, C
	2.2pF (2R2)	V	V	A, B, C
	2.7pF (2R7)	V	V	A, B, C
	3.0pF (3R0)	V	V	A, B, C
	3.3pF (3R3)	V	V	A, B, C
	3.9pF (3R9)	V	V	A, B, C
	4.0pF (4R0)	V	V	A, B, C
	4.7pF (4R7)	V	V	A, B, C
	5.0pF (5R0)	V	V	A, B, C
	5.6pF (5R6)	V	V	B, C, D
6.0pF (6R0)	V	V	B, C, D	
6.8pF (6R8)	V		B, C, D	
7.0pF (7R0)	V		B, C, D	
8.0pF (8R0)	V		B, C, D	
8.2pF (8R2)	V		B, C, D	
9.0pF (9R0)	V		B, C, D	
10pF (100)	V	V	C, D, G	
12pF (120)	V	V	J	
15pF (150)	V	V	J	
20pF (200)	V	V	J	
22pF (220)	V	V	J	

1. The letter in cell is expressed the symbol of product thickness.
2. For more information about products with special capacitance or other data, please contact WTC local representative.

DIELECTRIC		NP0								Tolerance
SIZE		0201				0402				
RATED VOLTAGE (VDC)		6.3	10	25	50	25	50	100	200	
Capacitance	0.1pF (0R1)	L	L	L	L	N	N	N	N	B
	0.2pF (0R2)	L	L	L	L	N	N	N	N	A, B
	0.3pF (0R3)	L	L	L	L	N	N	N	N	A, B
	0.4pF (0R4)	L	L	L	L	N	N	N	N	A, B
	0.5pF (0R5)	L	L	L	L	N	N	N	N	A, B, C
	0.6pF (0R6)	L	L	L	L	N	N	N	N	A, B, C
	0.7pF (0R7)	L	L	L	L	N	N	N	N	A, B, C
	0.8pF (0R8)	L	L	L	L	N	N	N	N	A, B, C
	0.9pF (0R9)	L	L	L	L	N	N	N	N	A, B, C
	1.0pF (1R0)	L	L	L	L	N	N	N	N	A, B, C
	1.1pF (1R1)	L	L	L	L	N	N	N	N	A, B, C
	1.2pF (1R2)	L	L	L	L	N	N	N	N	A, B, C
	1.3pF (1R3)	L	L	L	L	N	N	N	N	A, B, C
	1.4pF (1R4)	L	L	L	L	N	N	N	N	A, B, C
	1.5pF (1R5)	L	L	L	L	N	N	N	N	A, B, C
	1.6pF (1R6)	L	L	L	L	N	N	N	N	A, B, C
	1.7pF (1R7)	L	L	L	L	N	N	N	N	A, B, C
	1.8pF (1R8)	L	L	L	L	N	N	N	N	A, B, C
	1.9pF (1R9)	L	L	L	L	N	N	N	N	A, B, C
	2.0pF (2R0)	L	L	L	L	N	N	N	N	A, B, C
	2.1pF (2R1)	L	L	L	L	N	N	N	N	A, B, C
	2.2pF (2R2)	L	L	L	L	N	N	N	N	A, B, C
	2.3pF (2R3)	L	L	L	L	N	N	N	N	A, B, C
	2.4pF (2R4)	L	L	L	L	N	N	N	N	A, B, C
	2.5pF (2R5)	L	L	L	L	N	N	N	N	A, B, C
	2.6pF (2R6)	L	L	L	L	N	N	N	N	A, B, C
	2.7pF (2R7)	L	L	L	L	N	N	N	N	A, B, C
	2.8pF (2R8)	L	L	L	L	N	N	N	N	A, B, C
	2.9pF (2R9)	L	L	L	L	N	N	N	N	A, B, C
	3.0pF (3R0)	L	L	L	L	N	N	N	N	A, B, C
	3.1pF (3R1)	L	L	L	L	N	N	N	N	A, B, C
	3.2pF (3R2)	L	L	L	L	N	N	N	N	A, B, C
	3.3pF (3R3)	L	L	L	L	N	N	N	N	A, B, C
	3.4pF (3R4)	L	L	L	L	N	N	N	N	A, B, C
	3.5pF (3R5)	L	L	L	L	N	N	N	N	A, B, C
	3.6pF (3R6)	L	L	L	L	N	N	N	N	A, B, C
	3.7pF (3R7)	L	L	L	L	N	N	N	N	A, B, C
	3.8pF (3R8)	L	L	L	L	N	N	N	N	A, B, C
	3.9pF (3R9)	L	L	L	L	N	N	N	N	A, B, C
	4.0pF (4R0)	L	L	L	L	N	N	N	N	A, B, C
4.1pF (4R1)	L	L	L	L	N	N	N	N	A, B, C	
4.2pF (4R2)	L	L	L	L	N	N	N	N	A, B, C	
4.3pF (4R3)	L	L	L	L	N	N	N	N	A, B, C	
4.4pF (4R4)	L	L	L	L	N	N	N	N	A, B, C	
4.5pF (4R5)	L	L	L	L	N	N	N	N	A, B, C	
4.6pF (4R6)	L	L	L	L	N	N	N	N	A, B, C	
4.7pF (4R7)	L	L	L	L	N	N	N	N	A, B, C	
4.8pF (4R8)	L	L	L	L	N	N	N	N	A, B, C	
4.9pF (4R9)	L	L	L	L	N	N	N	N	A, B, C	
5.0pF (5R0)	L	L	L	L	N	N	N	N	A, B, C	
5.1pF (5R1)	L	L	L	L	N	N	N	N	B, C, D	
5.2pF (5R2)	L	L	L	L	N	N	N	N	B, C, D	
5.3pF (5R3)	L	L	L	L	N	N	N	N	B, C, D	
5.4pF (5R4)	L	L	L	L	N	N	N	N	B, C, D	
5.5pF (5R5)	L	L	L	L	N	N	N	N	B, C, D	
5.6pF (5R6)	L	L	L	L	N	N	N	N	B, C, D	
5.7pF (5R7)	L	L	L	L	N	N	N	N	B, C, D	
5.8pF (5R8)	L	L	L	L	N	N	N	N	B, C, D	
5.9pF (5R9)	L	L	L	L	N	N	N	N	B, C, D	
6.0pF (6R0)	L	L	L	L	N	N	N	N	B, C, D	

1. The letter in cell is expressed the symbol of product thickness.
2. For more information about products with special capacitance or other data, please contact WTC local representative.

DIELECTRIC		NP0								Tolerance
SIZE		0201				0402				
RATED VOLTAGE (VDC)		6.3	10	25	50	25	50	100	200	
Capacitance	6.1pF (6R1)	L	L	L	L	N	N	N	N	B, C, D
	6.2pF (6R2)	L	L	L	L	N	N	N	N	B, C, D
	6.3pF (6R3)	L	L	L	L	N	N	N	N	B, C, D
	6.4pF (6R4)	L	L	L	L	N	N	N	N	B, C, D
	6.5pF (6R5)	L	L	L	L	N	N	N	N	B, C, D
	6.6pF (6R6)	L	L	L	L	N	N	N	N	B, C, D
	6.7pF (6R7)	L	L	L	L	N	N	N	N	B, C, D
	6.8pF (6R8)	L	L	L	L	N	N	N	N	B, C, D
	6.9pF (6R9)	L	L	L	L	N	N	N	N	B, C, D
	7.0pF (7R0)	L	L	L	L	N	N	N	N	B, C, D
	7.1pF (7R1)	L	L	L	L	N	N	N	N	B, C, D
	7.2pF (7R2)	L	L	L	L	N	N	N	N	B, C, D
	7.3pF (7R3)	L	L	L	L	N	N	N	N	B, C, D
	7.4pF (7R4)	L	L	L	L	N	N	N	N	B, C, D
	7.5pF (7R5)	L	L	L	L	N	N	N	N	B, C, D
	7.6pF (7R6)	L	L	L	L	N	N	N	N	B, C, D
	7.7pF (7R7)	L	L	L	L	N	N	N	N	B, C, D
	7.8pF (7R8)	L	L	L	L	N	N	N	N	B, C, D
	7.9pF (7R9)	L	L	L	L	N	N	N	N	B, C, D
	8.0pF (8R0)	L	L	L	L	N	N	N	N	B, C, D
	8.1pF (8R1)	L	L	L	L	N	N	N	N	B, C, D
	8.2pF (8R2)	L	L	L	L	N	N	N	N	B, C, D
	8.3pF (8R3)	L	L	L	L	N	N	N	N	B, C, D
	8.4pF (8R4)	L	L	L	L	N	N	N	N	B, C, D
	8.5pF (8R5)	L	L	L	L	N	N	N	N	B, C, D
	8.6pF (8R6)	L	L	L	L	N	N	N	N	B, C, D
	8.7pF (8R7)	L	L	L	L	N	N	N	N	B, C, D
	8.8pF (8R8)	L	L	L	L	N	N	N	N	B, C, D
	8.9pF (8R9)	L	L	L	L	N	N	N	N	B, C, D
	9.0pF (9R0)	L	L	L	L	N	N	N	N	B, C, D
	9.1pF (9R1)	L	L	L	L	N	N	N	N	B, C, D
	9.2pF (9R2)	L	L	L	L	N	N	N	N	B, C, D
	9.3pF (9R3)	L	L	L	L	N	N	N	N	B, C, D
	9.4pF (9R4)	L	L	L	L	N	N	N	N	B, C, D
	9.5pF (9R5)	L	L	L	L	N	N	N	N	B, C, D
	9.6pF (9R6)	L	L	L	L	N	N	N	N	B, C, D
	9.7pF (9R7)	L	L	L	L	N	N	N	N	B, C, D
	9.8pF (9R8)	L	L	L	L	N	N	N	N	B, C, D
	9.9pF (9R9)	L	L	L	L	N	N	N	N	B, C, D
	10pF (100)	L	L	L	L	N	N	N	N	F, G, J
11pF (110)	L	L	L	L	N	N	N	N	F, G, J	
12pF (120)	L	L	L	L	N	N	N	N	F, G, J	
13pF (130)	L	L	L	L	N	N	N	N	F, G, J	
15pF (150)	L	L	L	L	N	N	N	N	F, G, J	
16pF (160)	L	L	L	L	N	N	N	N	F, G, J	
18pF (180)	L	L	L	L	N	N	N	N	F, G, J	
20pF (200)	L	L	L	L	N	N	N	N	F, G, J	
22pF (220)	L	L	L	L	N	N	N	N	F, G, J	
24pF (240)	L	L	L	L	N	N	N	N	F, G, J	
27pF (270)	L	L	L	L	N	N	N	N	F, G, J	
30pF (300)	L	L	L	L	N	N	N	N	F, G, J	
33pF (330)	L	L	L	L	N	N	N	N	F, G, J	
36pF (360)					N	N	N	N	F, G, J	
39pF (390)					N	N	N	N	F, G, J	
43pF (430)					N	N	N	N	F, G, J	
47pF (470)					N	N	N	N	F, G, J	
56pF (560)					N	N	N	N	F, G, J	
68pF (680)					N	N	N	N	F, G, J	
82pF (820)					N	N	N	N	F, G, J	
100pF (101)					N	N	N	N	F, G, J	

1. The letter in cell is expressed the symbol of product thickness.
2. For more information about products with special capacitance or other data, please contact WTC local representative.

DIELECTRIC		NP0							Tolerance
SIZE		0603			0805				
RATED VOLTAGE (VDC)		50	100	250	50	100	250	500	
Capacitance	0.1pF (0R1)	H	H	H					
	0.2pF (0R2)	H	H	H	A	A	A	A	
	0.3pF (0R3)	S	S	S	T	T	T	T	A, B
	0.4pF (0R4)	S	S	S	T	T	T	T	A, B
	0.5pF (0R5)	S	S	S	T	T	T	T	A, B, C
	0.6pF (0R6)	S	S	S	T	T	T	T	A, B, C
	0.7pF (0R7)	S	S	S	T	T	T	T	A, B, C
	0.8pF (0R8)	S	S	S	T	T	T	T	A, B, C
	0.9pF (0R9)	S	S	S	T	T	T	T	A, B, C
	1.0pF (1R0)	S	S	S	T	T	T	T	A, B, C
	1.1pF (1R1)	S	S	S	T	T	T	T	A, B, C
	1.2pF (1R2)	S	S	S	T	T	T	T	A, B, C
	1.3pF (1R3)	S	S	S	T	T	T	T	A, B, C
	1.4pF (1R4)	S	S	S	T	T	T	T	A, B, C
	1.5pF (1R5)	S	S	S	T	T	T	T	A, B, C
	1.6pF (1R6)	S	S	S	T	T	T	T	A, B, C
	1.7pF (1R7)	S	S	S	T	T	T	T	A, B, C
	1.8pF (1R8)	S	S	S	T	T	T	T	A, B, C
	1.9pF (1R9)	S	S	S	T	T	T	T	A, B, C
	2.0pF (2R0)	S	S	S	T	T	T	T	A, B, C
	2.1pF (2R1)	S	S	S	T	T	T	T	A, B, C
	2.2pF (2R2)	S	S	S	T	T	T	T	A, B, C
	2.3pF (2R3)	S	S	S	T	T	T	T	A, B, C
	2.4pF (2R4)	S	S	S	T	T	T	T	A, B, C
	2.5pF (2R5)	S	S	S	T	T	T	T	A, B, C
	2.6pF (2R6)	S	S	S	T	T	T	T	A, B, C
	2.7pF (2R7)	S	S	S	T	T	T	T	A, B, C
	2.8pF (2R8)	S	S	S	T	T	T	T	A, B, C
	2.9pF (2R9)	S	S	S	T	T	T	T	A, B, C
	3.0pF (3R0)	S	S	S	T	T	T	T	A, B, C
	3.1pF (3R1)	S	S	S	T	T	T	T	A, B, C
	3.2pF (3R2)	S	S	S	T	T	T	T	A, B, C
	3.3pF (3R3)	S	S	S	T	T	T	T	A, B, C
	3.4pF (3R4)	S	S	S	T	T	T	T	A, B, C
	3.5pF (3R5)	S	S	S	T	T	T	T	A, B, C
	3.6pF (3R6)	S	S	S	T	T	T	T	A, B, C
	3.7pF (3R7)	S	S	S	T	T	T	T	A, B, C
	3.8pF (3R8)	S	S	S	T	T	T	T	A, B, C
	3.9pF (3R9)	S	S	S	T	T	T	T	A, B, C
	4.0pF (4R0)	S	S	S	T	T	T	T	A, B, C
4.1pF (4R1)	S	S	S	T	T	T	T	A, B, C	
4.2pF (4R2)	S	S	S	T	T	T	T	A, B, C	
4.3pF (4R3)	S	S	S	T	T	T	T	A, B, C	
4.4pF (4R4)	S	S	S	T	T	T	T	A, B, C	
4.5pF (4R5)	S	S	S	T	T	T	T	A, B, C	
4.6pF (4R6)	S	S	S	T	T	T	T	A, B, C	
4.7pF (4R7)	S	S	S	T	T	T	T	A, B, C	
4.8pF (4R8)	S	S	S	T	T	T	T	A, B, C	
4.9pF (4R9)	S	S	S	T	T	T	T	A, B, C	
5.0pF (5R0)	S	S	S	T	T	T	T	A, B, C	
5.1pF (5R1)	S	S	S	T	T	T	T	B, C, D	
5.2pF (5R2)	S	S	S	T	T	T	T	B, C, D	
5.3pF (5R3)	S	S	S	T	T	T	T	B, C, D	
5.4pF (5R4)	S	S	S	T	T	T	T	B, C, D	
5.5pF (5R5)	S	S	S	T	T	T	T	B, C, D	
5.6pF (5R6)	S	S	S	T	T	T	T	B, C, D	
5.7pF (5R7)	S	S	S	T	T	T	T	B, C, D	
5.8pF (5R8)	S	S	S	T	T	T	T	B, C, D	
5.9pF (5R9)	S	S	S	T	T	T	T	B, C, D	
6.0pF (6R0)	S	S	S	T	T	T	T	B, C, D	

1. The letter in cell is expressed the symbol of product thickness.
2. For more information about products with special capacitance or other data, please contact WTC local representative.

DIELECTRIC		NP0							Tolerance
SIZE		0603			0805				
RATED VOLTAGE (VDC)		50	100	250	50	100	250	500	
Capacitance	6.1pF (6R1)	S	S	S	T	T	T	T	B, C, D
	6.2pF (6R2)	S	S	S	T	T	T	T	B, C, D
	6.3pF (6R3)	S	S	S	T	T	T	T	B, C, D
	6.4pF (6R4)	S	S	S	T	T	T	T	B, C, D
	6.5pF (6R5)	S	S	S	T	T	T	T	B, C, D
	6.6pF (6R6)	S	S	S	T	T	T	T	B, C, D
	6.7pF (6R7)	S	S	S	T	T	T	T	B, C, D
	6.8pF (6R8)	S	S	S	T	T	T	T	B, C, D
	6.9pF (6R9)	S	S	S	T	T	T	T	B, C, D
	7.0pF (7R0)	S	S	S	T	T	T	T	B, C, D
	7.1pF (7R1)	S	S	S	T	T	T	T	B, C, D
	7.2pF (7R2)	S	S	S	T	T	T	T	B, C, D
	7.3pF (7R3)	S	S	S	T	T	T	T	B, C, D
	7.4pF (7R4)	S	S	S	T	T	T	T	B, C, D
	7.5pF (7R5)	S	S	S	T	T	T	T	B, C, D
	7.6pF (7R6)	S	S	S	T	T	T	T	B, C, D
	7.7pF (7R7)	S	S	S	T	T	T	T	B, C, D
	7.8pF (7R8)	S	S	S	T	T	T	T	B, C, D
	7.9pF (7R9)	S	S	S	T	T	T	T	B, C, D
	8.0pF (8R0)	S	S	S	T	T	T	T	B, C, D
	8.1pF (8R1)	S	S	S	T	T	T	T	B, C, D
	8.2pF (8R2)	S	S	S	T	T	T	T	B, C, D
	8.3pF (8R3)	S	S	S	T	T	T	T	B, C, D
	8.4pF (8R4)	S	S	S	T	T	T	T	B, C, D
	8.5pF (8R5)	S	S	S	T	T	T	T	B, C, D
	8.6pF (8R6)	S	S	S	T	T	T	T	B, C, D
	8.7pF (8R7)	S	S	S	T	T	T	T	B, C, D
	8.8pF (8R8)	S	S	S	T	T	T	T	B, C, D
	8.9pF (8R9)	S	S	S	T	T	T	T	B, C, D
	9.0pF (9R0)	S	S	S	T	T	T	T	B, C, D
	9.1pF (9R1)	S	S	S	T	T	T	T	B, C, D
	9.2pF (9R2)	S	S	S	T	T	T	T	B, C, D
	9.3pF (9R3)	S	S	S	T	T	T	T	B, C, D
	9.4pF (9R4)	S	S	S	T	T	T	T	B, C, D
	9.5pF (9R5)	S	S	S	T	T	T	T	B, C, D
	9.6pF (9R6)	S	S	S	T	T	T	T	B, C, D
	9.7pF (9R7)	S	S	S	T	T	T	T	B, C, D
	9.8pF (9R8)	S	S	S	T	T	T	T	B, C, D
	9.9pF (9R9)	S	S	S	T	T	T	T	B, C, D
	10pF (100)	S	S	S	T	T	T	T	F, G, J
11pF (110)	S	S	S	T	T	T	T	F, G, J	
12pF (120)	S	S	S	T	T	T	T	F, G, J	
13pF (130)	S	S	S	T	T	T	T	F, G, J	
15pF (150)	S	S	S	T	T	T	T	F, G, J	
16pF (160)	S	S	S	T	T	T	T	F, G, J	
18pF (180)	S	S	S	T	T	T	T	F, G, J	
20pF (200)	S	S	S	T	T	T	T	F, G, J	
22pF (220)	S	S	S	T	T	T	T	F, G, J	
24pF (240)	S	S	S	T	T	T	T	F, G, J	
27pF (270)	S	S	S	T	T	T	T	F, G, J	
30pF (300)	S	S	S	T	T	T	T	F, G, J	
33pF (330)	S	S	S	T	T	T	T	F, G, J	
36pF (360)	S	S	S	T	T	T	T	F, G, J	
39pF (390)	S	S	S	T	T	T	T	F, G, J	
43pF (430)	S	S	S	T	T	T	T	F, G, J	
47pF (470)	S	S	S	T	T	T	T	F, G, J	
56pF (560)	S	S	S	T	T	T	T	F, G, J	
68pF (680)	S	S	S	T	T	T	T	F, G, J	
82pF (820)	S	S	S	T	T	T	T	F, G, J	
100pF (101)	S	S	S	T	T	T	T	F, G, J	

1. The letter in cell is expressed the symbol of product thickness.
2. For more information about products with special capacitance or other data, please contact WTC local representative.

9. ELECTRICAL CHARACTERISTICS

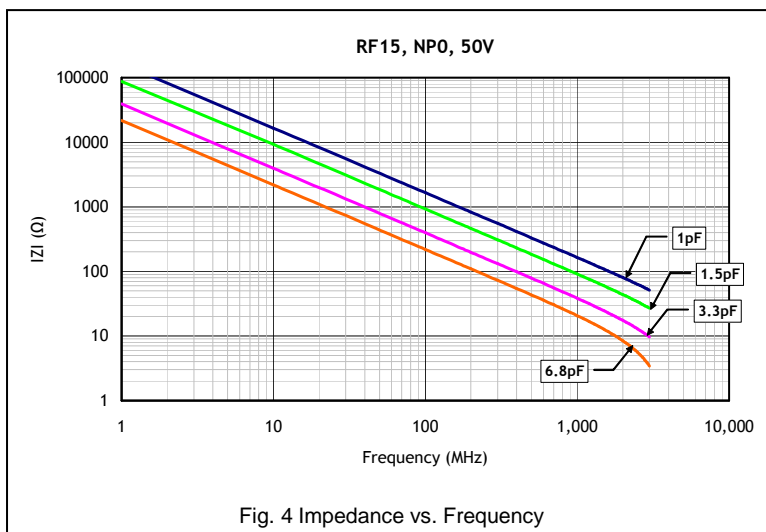
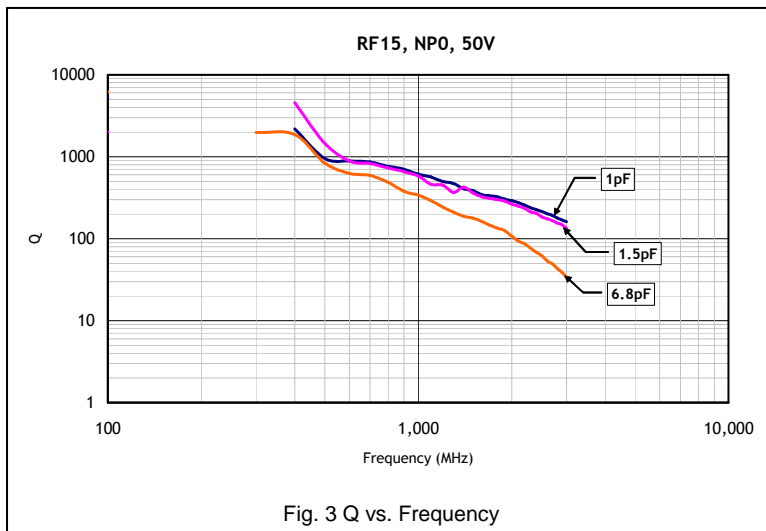
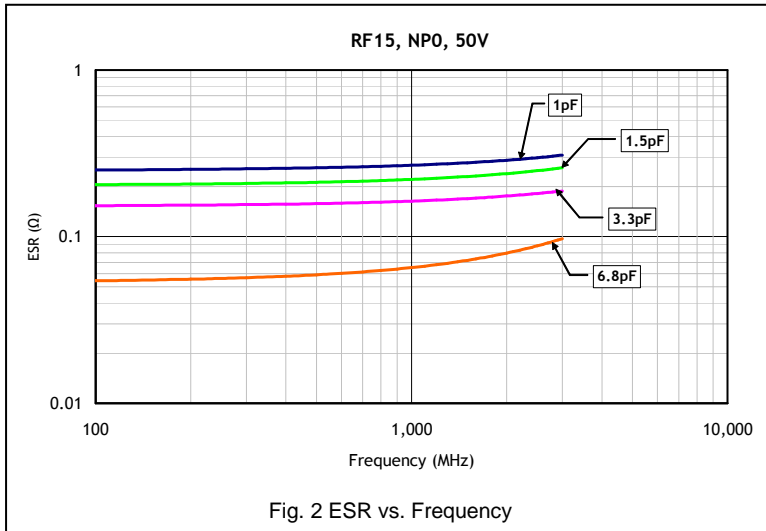

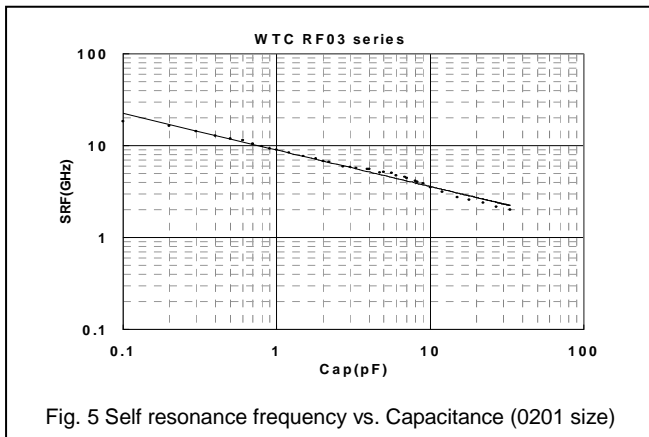

Fig. 5 Self resonance frequency vs. Capacitance (0201 size)

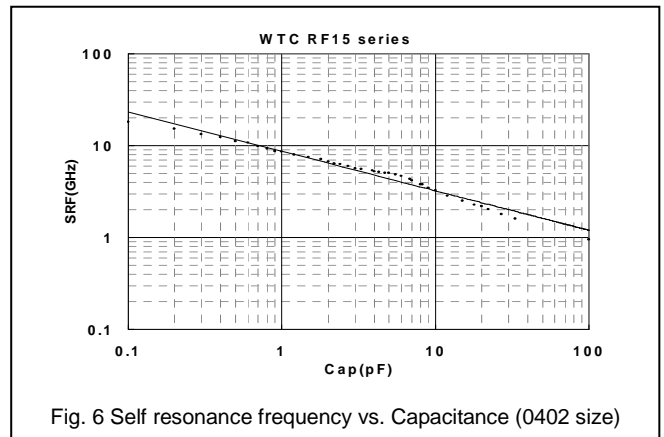

Fig. 6 Self resonance frequency vs. Capacitance (0402 size)

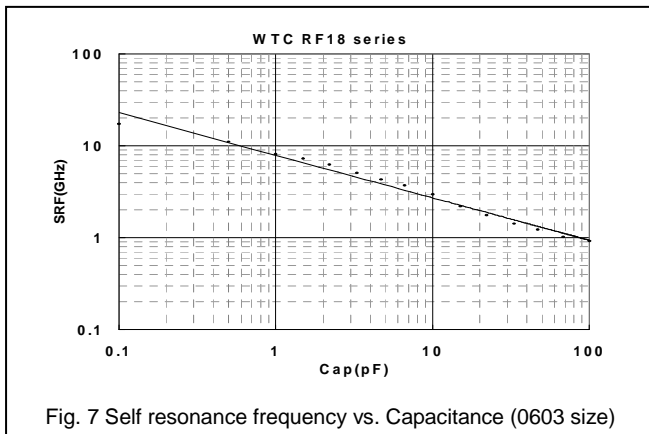

Fig. 7 Self resonance frequency vs. Capacitance (0603 size)

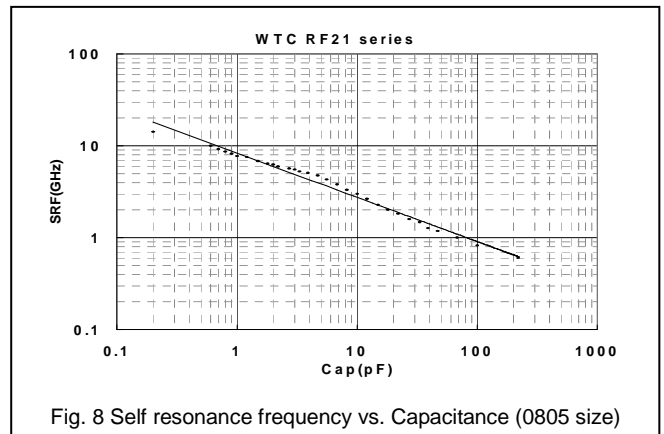

Fig. 8 Self resonance frequency vs. Capacitance (0805 size)

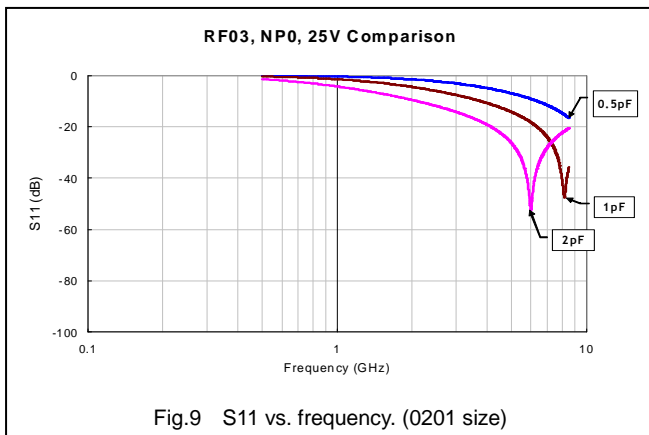

Fig.9 S11 vs. frequency. (0201 size)

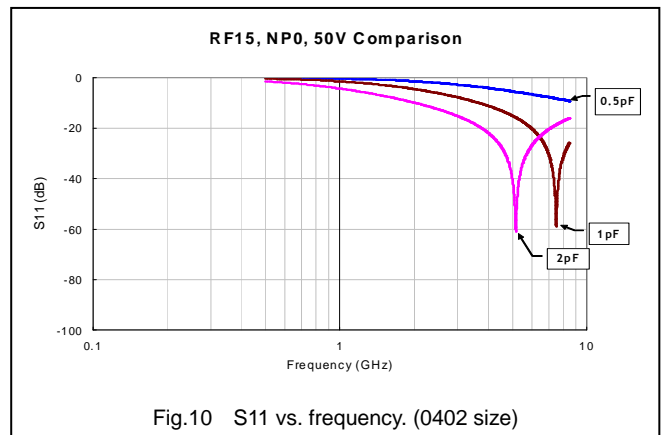

Fig.10 S11 vs. frequency. (0402 size)

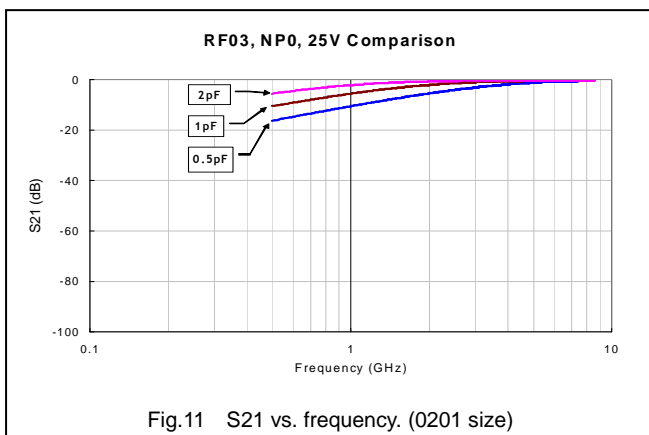

Fig.11 S21 vs. frequency. (0201 size)

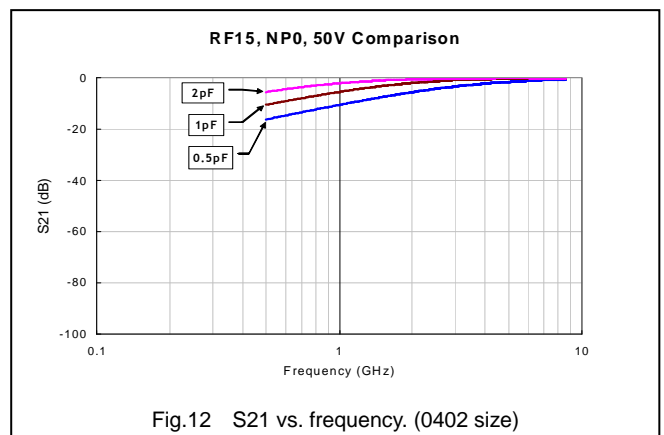

Fig.12 S21 vs. frequency. (0402 size)

10. RELIABILITY TEST CONDITIONS AND REQUIREMENTS

No.	Item	Test Conditions	Requirements
1.	Visual and Mechanical		No remarkable defect. Dimensions to conform to individual specification sheet.
2.	Capacitance	1.0±0.2Vrms, 1MHz±10%	Shall not exceed the limits given in the detailed spec.
3.	Q/ D.F. (Dissipation Factor)	At 25°C ambient temperature.	01005, 0201, 0402/25V~50V: Cap<30pF,Q≥400+20C;Cap≥30pF, Q≥1000 0402/100V~200V, 0603, 0805, 0505: Cap<30pF:Q≥800+20C;Cap≥30pF:Q≥1400
4.	Dielectric Strength	To apply voltage: ≤100V, ≥250% of rated voltage. Duration: 1 to 5 sec. Charge and discharge current less than 50mA. To apply voltage: 200V~300V ≥2 times VDC 500V~999V ≥1.5 times VDC 1000V~3000V ≥1.2 times VDC Cut-off, set at 10mA TEST= 15 sec. RAMP=0	No evidence of damage or flash over during test.
5.	Insulation Resistance	≤100V : To apply rated voltage for max. 120 sec. ≥200V :To apply rated voltage (500V max.) for 60 sec.	≥10GΩ or RxC≥100Ω-F whichever is smaller
6.	Temperature Coefficient	With no electrical load. Operating temperature: -55~125°C at 25°C	Capacitance change: within ±30ppm/°C; 0201Cap≥22pF, within ±60ppm/°C
7.	Adhesive Strength of Termination	Pressurizing force : 01005: 1N 0201: 2N 0402 & 0603: 5N >0603: 10N * Test time: 10±1 sec.	No remarkable damage or removal of the terminations.
8.	Vibration Resistance	Vibration frequency: 10~55 Hz/min. Total amplitude: 1.5mm * Test time: 6 hrs. (Two hrs each in three mutually perpendicular directions.) Measurement to be made after keeping at room temp. for 24±2 hrs.	No remarkable damage. Cap change and Q/D.F.: To meet initial spec.
9.	Solderability	Solder temperature: 235±5°C Dipping time: 2±0.5 sec.	95% min. coverage of all metalized area.
10.	Bending Test	* The middle part of substrate shall be pressurized by means of the pressurizing rod at a rate of about 1 mm per second until the deflection becomes 1 mm and then the pressure shall be maintained for 5±1 sec. * Measurement to be made after keeping at room temp. for 24±2 hrs.	No remarkable damage. * Cap change: within ±5.0% or ±0.5pF whichever is larger. (This capacitance change means the change of capacitance under specified flexure of substrate from the capacitance measured before the test.)
11.	Resistance to Soldering Heat	* Solder temperature: 260±5°C * Dipping time: 10±1 sec * Preheating: 120 to 150°C for 1 minute before immerse the capacitor in a eutectic solder. * Before initial measurement (Class II only): Perform 150+0/-10°C for 1 hr and then set for 24±2 hrs at room temp. * Measurement to be made after keeping at room temp. for 24±2 hrs.	* No remarkable damage. * Cap change: within ±2.5% or ±0.25pF whichever is larger. Q/D.F., I.R. and dielectric strength: To meet initial requirements. 25% max. leaching on each edge.

No.	Item	Test Condition	Requirements																												
12.	Temperature Cycle	<p>* Conduct the five cycles according to the temperatures and time.</p> <table border="1"> <thead> <tr> <th>Step</th> <th>Temp. (°C)</th> <th>Time (min.)</th> </tr> </thead> <tbody> <tr> <td>1</td> <td>Min. operating temp. +0/-3</td> <td>30±3</td> </tr> <tr> <td>2</td> <td>Room temp.</td> <td>2~3</td> </tr> <tr> <td>3</td> <td>Max. operating temp. +3/-0</td> <td>30±3</td> </tr> <tr> <td>4</td> <td>Room temp.</td> <td>2~3</td> </tr> </tbody> </table> <p>* Before initial measurement (Class II only): Perform 150+0/-10°C for 1 hr and then set for 24±2 hrs at room temp. * Measurement to be made after keeping at room temp. for 24±2 hrs.</p>	Step	Temp. (°C)	Time (min.)	1	Min. operating temp. +0/-3	30±3	2	Room temp.	2~3	3	Max. operating temp. +3/-0	30±3	4	Room temp.	2~3	<p>* No remarkable damage. * Cap change : within ±2.5% or ±0.25pF whichever is larger. * Q/D.F., I.R. and dielectric strength: To meet initial requirements.</p>													
Step	Temp. (°C)	Time (min.)																													
1	Min. operating temp. +0/-3	30±3																													
2	Room temp.	2~3																													
3	Max. operating temp. +3/-0	30±3																													
4	Room temp.	2~3																													
13.	Humidity (Damp Heat) Steady State	<p>* Test temp.: 40±2°C * Humidity: 90~95% RH * Test time: 500+24/-0hrs. * Before initial measurement (Class II only): Perform 150+0/-10°C for 1 hr and then set for 24±2 hrs at room temp. * Measurement to be made after keeping at room temp. for 24±2 hrs.</p>	<p>* No remarkable damage. * Cap change: within ±5.0% or ±0.5pF whichever is larger. * Q/D.F. value: Cap≥30pF, Q≥350; 10pF≤Cap<30pF, Q≥275+2.5C Cap<10pF; Q≥200+10C * I.R.: ≥1GΩ.</p>																												
14.	Humidity (Damp Heat) Load	<p>* Test temp.: 40±2°C * Humidity: 90~95%RH * Test time: 500+24/-0 hrs. * To apply voltage : rated voltage * Before initial measurement (Class II only): To apply test voltage for 1hr at 40°C and then set for 24±2 hrs at room temp. * Measurement to be made after keeping at room temp. for 24±2 hrs.</p>	<p>* No remarkable damage. * Cap change: within ±7.5% or ±0.75pF whichever is larger. * Q/D.F. value: Cap≥30pF, Q≥200; Cap<30pF, Q≥100+10/3C * I.R.: ≥500MΩ.</p>																												
15.	High Temperature Load (Endurance)	<p>* Test temp.: 125±3°C * To apply voltage: (1) 10V ≤ Ur < 500V: 200% of rated voltage. (2) ≤ 6.3V or 500V: 150% of rated voltage. (3) Ur ≥ 630V: 120% of rated voltage. * Test time: 1000+24/-0 hrs. * Before initial measurement (Class II only): To apply test voltage for 1hr at test temp. and then set for 24±2 hrs at room temp. * Measurement to be made after keeping at room temp. for 24±2 hrs</p>	<p>* No remarkable damage. * Cap change: within ±3.0% or ±0.3pF whichever is larger. * Q/D.F. value: Cap≥30pF, Q≥350 10pF≤Cap<30pF, Q≥275+2.5C Cap<10pF, Q≥200+10C * I.R.: ≥1GΩ.</p>																												
16.	ESR	<p>The ESR should be measured at room temperature and tested at frequency 1±0.1 GHz.</p>	<table border="1"> <thead> <tr> <th colspan="2">01005</th> </tr> </thead> <tbody> <tr> <td colspan="2">0.2pF≤Cap≤1pF:< 700mΩ/pF</td> </tr> <tr> <td colspan="2">1pF<Cap≤2pF:< 600mΩ</td> </tr> <tr> <td colspan="2">2pF<Cap≤5pF:< 500mΩ</td> </tr> <tr> <td colspan="2">5pF<Cap≤10pF:< 300mΩ</td> </tr> <tr> <td colspan="2">10pF<Cap≤22pF:< 350mΩ</td> </tr> <tr> <th>0201</th> <th>0402</th> </tr> <tr> <td>0.1pF≤Cap≤1pF:< 350mΩ/pF</td> <td>0.1pF≤Cap≤1pF:< 350mΩ/pF</td> </tr> <tr> <td>1pF<Cap≤5pF:< 300mΩ</td> <td>1pF<Cap≤5pF:< 300mΩ</td> </tr> <tr> <td>5pF<Cap≤22pF:< 250mΩ</td> <td>5pF<Cap≤100pF:< 250mΩ</td> </tr> <tr> <th>0603</th> <th>0805</th> </tr> <tr> <td>0.3pF≤Cap≤1pF:< 1500mΩ</td> <td>0.3pF≤Cap≤1pF: < 1500mΩ</td> </tr> <tr> <td>1pF<Cap≤10pF:< 250mΩ</td> <td>1pF<Cap≤10pF: < 250mΩ</td> </tr> <tr> <td>10pF<Cap≤100pF:< 200mΩ</td> <td>Cap>10pF: < 200mΩ</td> </tr> </tbody> </table> <p>The ESR should be measured at room temperature and tested at frequency 500±50 MHz.</p>	01005		0.2pF≤Cap≤1pF:< 700mΩ/pF		1pF<Cap≤2pF:< 600mΩ		2pF<Cap≤5pF:< 500mΩ		5pF<Cap≤10pF:< 300mΩ		10pF<Cap≤22pF:< 350mΩ		0201	0402	0.1pF≤Cap≤1pF:< 350mΩ/pF	0.1pF≤Cap≤1pF:< 350mΩ/pF	1pF<Cap≤5pF:< 300mΩ	1pF<Cap≤5pF:< 300mΩ	5pF<Cap≤22pF:< 250mΩ	5pF<Cap≤100pF:< 250mΩ	0603	0805	0.3pF≤Cap≤1pF:< 1500mΩ	0.3pF≤Cap≤1pF: < 1500mΩ	1pF<Cap≤10pF:< 250mΩ	1pF<Cap≤10pF: < 250mΩ	10pF<Cap≤100pF:< 200mΩ	Cap>10pF: < 200mΩ
01005																															
0.2pF≤Cap≤1pF:< 700mΩ/pF																															
1pF<Cap≤2pF:< 600mΩ																															
2pF<Cap≤5pF:< 500mΩ																															
5pF<Cap≤10pF:< 300mΩ																															
10pF<Cap≤22pF:< 350mΩ																															
0201	0402																														
0.1pF≤Cap≤1pF:< 350mΩ/pF	0.1pF≤Cap≤1pF:< 350mΩ/pF																														
1pF<Cap≤5pF:< 300mΩ	1pF<Cap≤5pF:< 300mΩ																														
5pF<Cap≤22pF:< 250mΩ	5pF<Cap≤100pF:< 250mΩ																														
0603	0805																														
0.3pF≤Cap≤1pF:< 1500mΩ	0.3pF≤Cap≤1pF: < 1500mΩ																														
1pF<Cap≤10pF:< 250mΩ	1pF<Cap≤10pF: < 250mΩ																														
10pF<Cap≤100pF:< 200mΩ	Cap>10pF: < 200mΩ																														

APPENDIXES

▣ Tape & reel dimensions

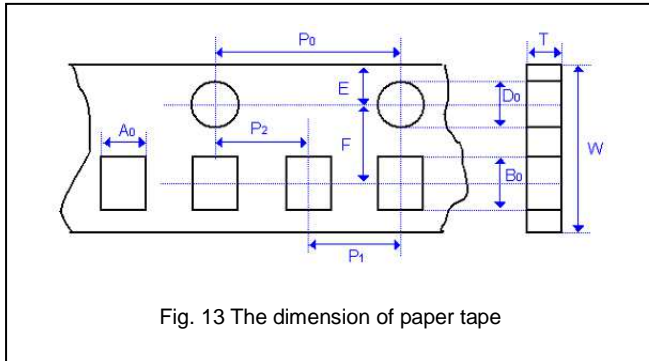

Fig. 13 The dimension of paper tape

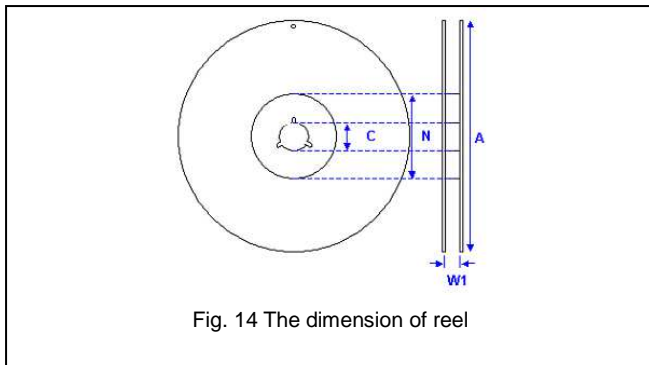
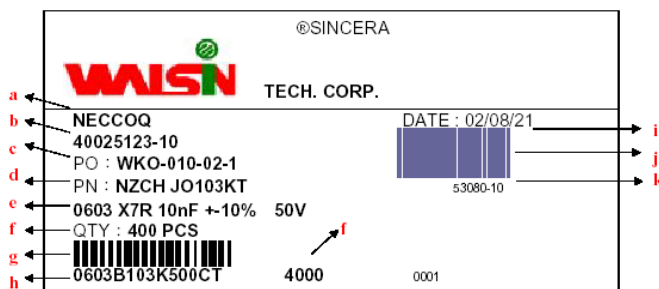

Fig. 14 The dimension of reel

Size	01005	0201	0402	0603	0805
Thickness	V	L	N	S	T
A₀	0.25 +/-0.05	0.39 +/-0.07	0.70 +/-0.2	1.05 +/-0.30	1.50 +/-0.20
B₀	0.45 +/-0.05	0.69 +/-0.07	1.20 +/-0.2	1.80 +/-0.30	2.30 +/-0.20
T	≤0.50	≤0.50	≤0.80	≤1.20	≤1.30
K₀	-	-	-	-	-
W	8.00 +/-0.10	8.00 +/-0.10	8.00 +/-0.10	8.00 +/-0.10	8.00 +/-0.10
P₀	4.00 +/-0.10	4.00 +/-0.10	4.00 +/-0.10	4.00 +/-0.10	4.00 +/-0.10
10xP₀	40.00 +/-0.10	40.00 +/-0.10	40.00 +/-0.10	40.00 +/-0.20	40.00 +/-0.20
P₁	2.00 +/-0.05	2.00 +/-0.05	2.00 +/-0.05	4.00 +/-0.10	4.00 +/-0.10
P₂	2.00 +/-0.05	2.00 +/-0.05	2.00 +/-0.05	2.00 +/-0.05	2.00 +/-0.05
D₀	1.55 +/-0.05	1.55 +/-0.05	1.55 +/-0.05	1.55 +/-0.05	1.55 +/-0.05
D₁	-	-	-	-	-
E	1.75 +/-0.05	1.75 +/-0.05	1.75 +/-0.05	1.75 +/-0.05	1.75 +/-0.05
F	3.50 +/-0.05	3.50 +/-0.05	3.50 +/-0.05	3.50 +/-0.05	3.50 +/-0.05

Size	01005, 0201, 0402, 0603, 0805	
Reel size	7"	13"
C	13.0+0.5/-0.2	13.0+0.5/-0.2
W₁	8.4+1.5/-0	8.4+1.5/-0
A	178.0±1.0	330.0±1.0
N	60.0+1.0/-0	100±1.0

▣ Description of customer label



- a. Customer name
- b. WTC order series and item number
- c. Customer P/O
- d. Customer P/N
- e. Description of product
- f. Quantity
- g. Bar code including quantity & WTC P/N or customer
- h. WTC P/N
- i. Shipping date
- j. Order bar code including series and item numbers
- k. Serial number of label

▣ **Constructions**

No.	Name	NPO	
①	Ceramic material	BaTiO ₃ based	
②	Inner electrode	Cu	
③	Termination	Inner layer	Cu
④		Middle layer	Ni
⑤		Outer layer	Sn (Matt)

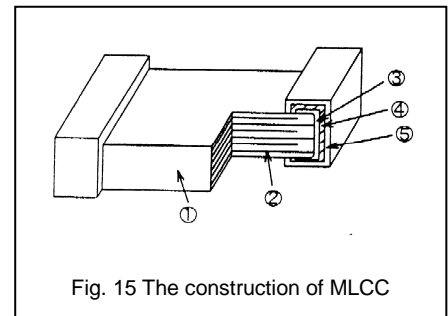

Fig. 15 The construction of MLCC

▣ **Storage and handling conditions**

- (1) To store products at 5 to 40°C ambient temperature and 20 to 70% related humidity conditions.
- (2) The product is recommended to be used within one year after shipment. Check solderability in case of shelf life extension is needed.

Cautions:

- a. The corrosive gas reacts on the terminal electrodes of capacitors, and results in the poor solderability. Do not store the capacitors in the ambience of corrosive gas (e.g., hydrogen sulfide, sulfur dioxide, chlorine, ammonia gas etc.)
- b. In corrosive atmosphere, solderability might be degraded, and silver migration might occur to cause low reliability.
- c. Due to the dewing by rapid humidity change, or the photochemical change of the terminal electrode by direct sunlight, the solderability and electrical performance may deteriorate. Do not store capacitors under direct sunlight or dewing condition. To store products on the shelf and avoid exposure to moisture.

▣ **Recommended soldering conditions**

The lead-free termination MLCCs are not only to be used on SMT against lead-free solder paste, but also suitable against lead-containing solder paste. If the optimized solder joint is requested, increasing soldering time, temperature and concentration of N₂ within oven are recommended.

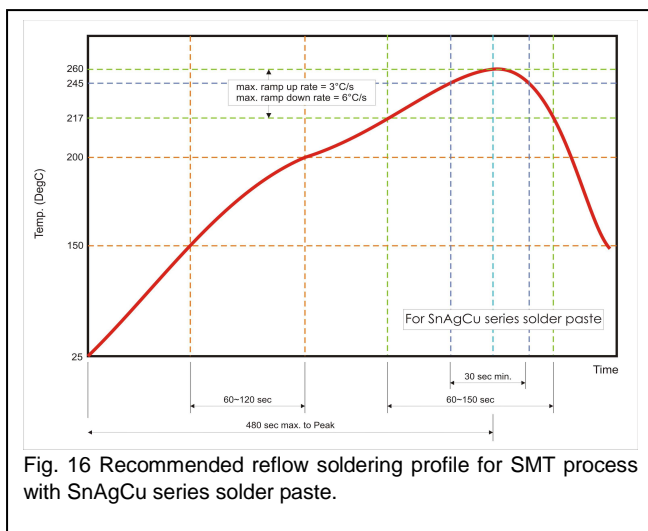

Fig. 16 Recommended reflow soldering profile for SMT process with SnAgCu series solder paste.

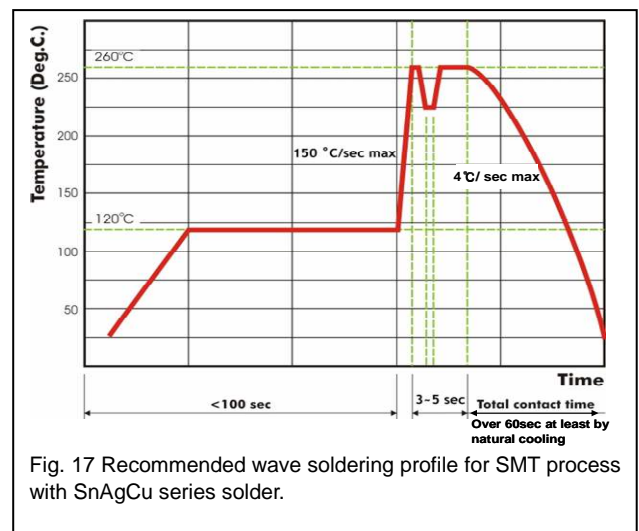

Fig. 17 Recommended wave soldering profile for SMT process with SnAgCu series solder.