

#### 4 一般特性(General Specification)

项 目 Item	规格/条件 Specification/Condition
01 产品型号Part No	SE-5R5-D155VY
02 额定放电容量Rate discharge capacitance (F 25℃ ΔV=3V-2.5V I=0.01A)	1.5
03 容量允许偏差Capacitance tolerance	-20%~+80%
04 额定电压Rated Voltage U <sub>0</sub> (V)	5.5
05 工作温度范围Operating temperature range	-25℃~70℃
06 最大等效串联电阻ESR(Ω 1KHz)	10
07 循环寿命Cycle life Expectancy	加额定电压，常温循环充放电实验50万次。 ΔC/C ≤30%, ESR≤4倍初始值(25℃)

#### 5 环境指标(Environmental)

项 目 Item	规格/条件 Specification/Condition
08 温度特性 Temperature characteristics	+70℃时  ΔC/C ≤30%，ESR≤规定值(25℃) -25℃时  ΔC/C ≤50%，ESR≤4倍初始值(25℃)
09 高温负荷特性 High temperature load	+70℃±2加额定电压，1000h后， ΔC/C ≤30%，ESR≤4倍规定值。
10 高温无负荷特性 High temperature without load	+70℃±2，1000±4h后， ΔC/C ≤30%，ESR≤2倍规定值。
11 湿热负荷特性 Humidity Resistance	+40℃±2，90-95%RH，240h， ΔC/C ≤30%，IL≤2倍规定值，ESR≤4倍规定值。

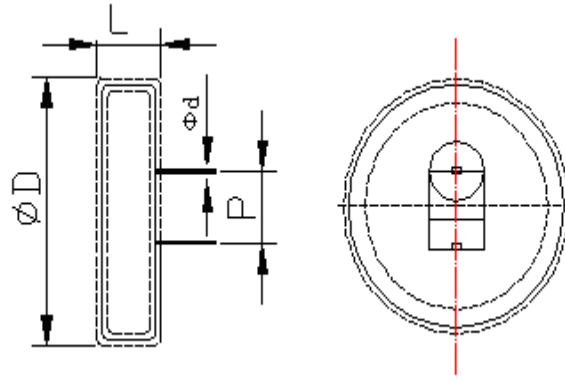

尺寸Size (mm $\Phi D \times L$ )	20.7( $\pm 0.5$ ) $\times$ 7.4( $\pm 0.5$ )
引线距离Down-lead distance(mm p)	6.0 $\pm$ 0.5
引线直径Down-lead diameter(mm $\Phi d$ )	1.0 $\pm$ 0.1

## 9 包装方法Packaging

产品型号	数量(PCS)			尺寸(L $\times$ W $\times$ H)mm		质量 Weight (Kg)
	管	内包装	外包装	内包装	外包装	
SE-5R5-D155VY	11	440	1760	270 $\times$ 195 $\times$ 95	415 $\times$ 295 $\times$ 210	

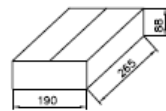

小箱

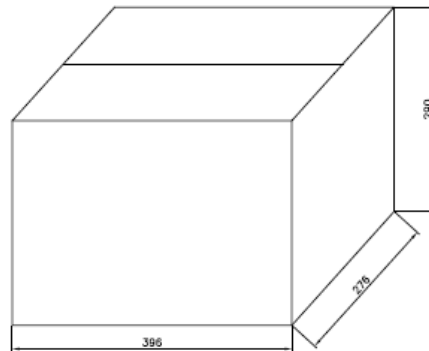

大箱

## 10 实验数据Test result

(1) 温度特性Temperature characteristics

(2) 寿命特性Life characteristics

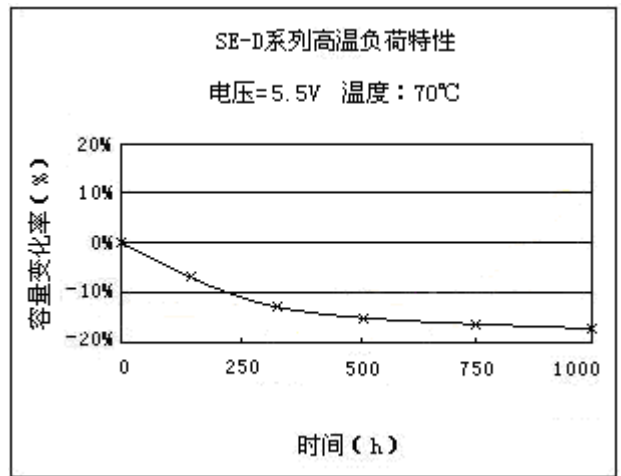
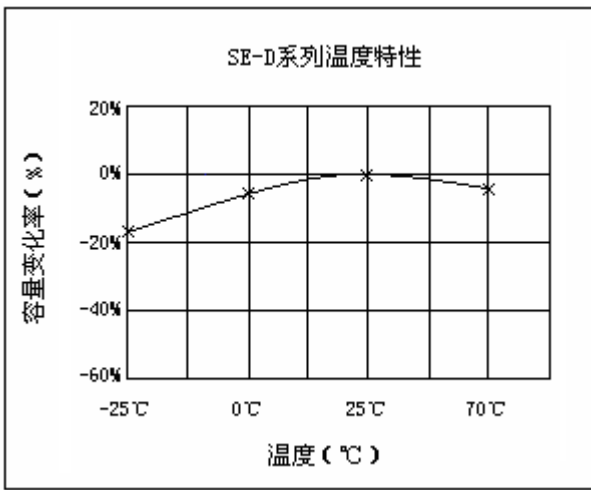
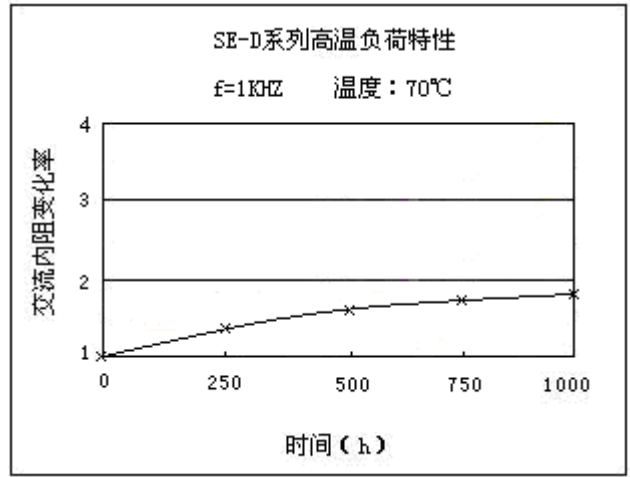
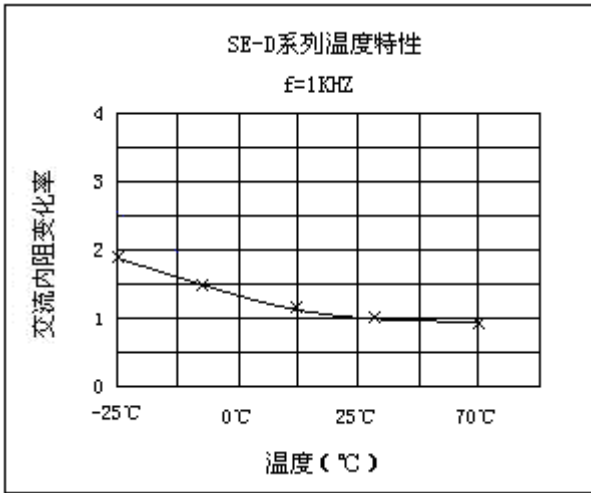

**(3) 漏电流曲线:**

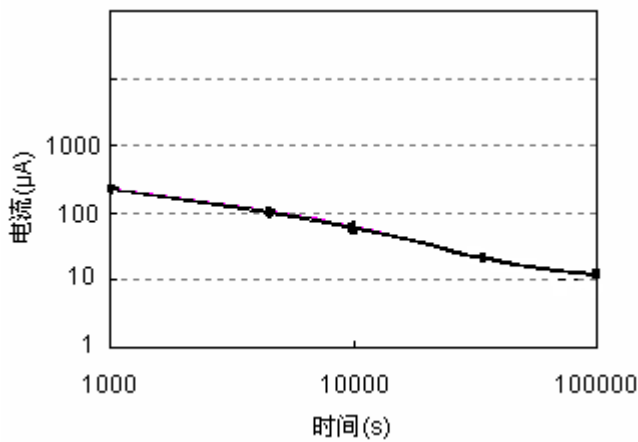

**(1) 依据标准**

IEC 62391-1 《Fixed electric double-layer capacitors for use in electronic equipment – Part 1: Generic specification》