



RoHS

Specification

Client Name :

客户名称 : _____

Client P/N :

客户品号 : _____

Product P/N :

产品型号 : HL-C3535K2G3EA

Sending Date :

送样日期 : _____

Client approval 客户审核		Hongli approval 鸿利光电审核		
Approval 核准	Audit 确认	Approval 核准	Audit 确认	Confirmation 制作
				马思达
<input type="checkbox"/> Qualified 接受	<input type="checkbox"/> Disqualified 不接受	DATE: 工程部 日期: 2015-05-21		

Adr : NO.1,Xianke Yi Road,Huadong Town,, Huadu District, Guangzhou, China

地址 : 中国广州市花都区花东镇先科一路1号

Tel/电话 : 020-86733333

Fax/传真 : 020-86733883 86733938 86733265

Web/网址 : www.honglitronic.com

注:1. 此规格书以中英文方式书写,若有冲突以中文版本为准文本.

2. 此规格书的最终解释权归广州市鸿利光电股份有限公司

3. 此规格书的有效期限为两年,自盖章或签字之日起计算,期满时双方可以续签协议,但应采用书面形式



ATTENTION
OBSERVE PRECAUTIONS
FOR HANDLING
ELECTROSTATIC
DISCHARGE
SENSITIVE
DEVICES

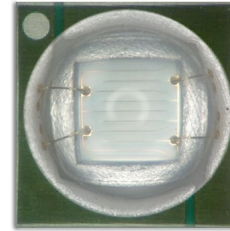

Features 特点

- Long operating life 寿命长
- High flux 光通量高
- More energy efficient than incandescent and most halogen lamps 比白炽灯与卤素灯节能
- Low voltage DC operated 低电压直流工作
- Cool beam, safe to the touch 冷光源，接触安全
- Instant light (less than 100ns) 瞬间点亮（小于100ns）
- Fully dimmable(属于可调光)
- No UV (无紫外线)
- Superior ESD protection(较好的防静电保护)
- RoHS compliant (符合RoHS标准)

Product naming rules 产品命名规则

C 3535 K2 G 3 E A
1 2 3 4 5 6 7

- 1：产品系列代码
- 2：尺寸代码
- 3：芯片代码
- 4：表示发光颜色为绿光
- 5：表示使用700mA分光
- 6：透镜代码
- 7：基板代码

Applications 应用

- Fiber optic alternative/Decorative/entertainment 光纤型/装饰/娱乐
- Landscape lighting 景观照明
- Stage Lighting 舞台照明
- Scene lighting 情景照明
- Bollards/Security/Garden 光柱/安全/花园
- Architectural, landscaping and entertainment/advertising installations. 建筑，园林绿化和娱乐/广告装置照明.

Radiation Pattern 辐射模式

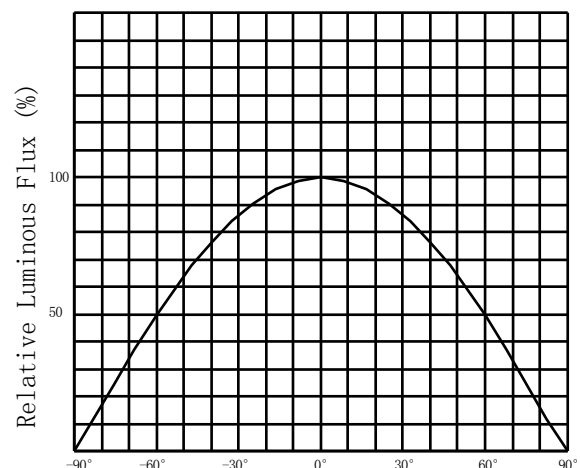
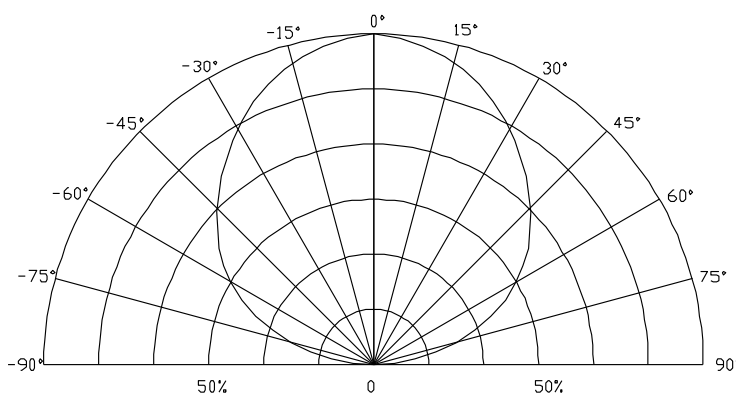

Specifications规范

(1) Typical Optical/ Electrical Characteristics @ $T_a=25^{\circ}\text{C}$ 典型的光学/电气特性在 $T_a=25^{\circ}\text{C}$

Symbol 符号	Item名称	Min. 最低	Typ. 典型	Max. 最高	Units 单位	Test Conditions 测试条件
Φ_V	Luminous Flux光通量	130	140	—	lm	IF=700mA
VF	Forward Voltage [1]正向电压	2.8	—	—	V	IF=700mA
λ_d	Wave Length主波长	520	—	530	nm	IF=700mA
$2\theta_{1/2}$	50% power angle发光角度	120	—	140	deg	IF=700mA
IR	Reverse Current反向电流	—	—	30	uA	VR = 5V

Notes注:

*1.the products after this specification refer to the parameters prevail, before the release of specification without refer to the above parameters.

此规格书发布日后生产的产品以上述参数为准, 发布前生产的库存品不参考上述参数。

2.Tolerance of measurement of forward voltage $\pm 3\%$ 、Wave Length $\pm 2\text{nm}$ 、luminous flux $\pm 5\%$

不同标准源测试存在仪器公差: 正向电压公差为 $\pm 3\%$ 、主波长公差为 $\pm 2\text{nm}$ 、光通量公差为 $\pm 5\%$ 。

3.All high power emitter LED products mounted on aluminum metal-core printed circuit board, can be lighted directly, but we do not recommend lighting the high power products for more than 5 seconds without a appropriate heat dissipation equipment. When using at 700mA, TS (cathode point) temperature should be controlled below 75°C , When using at 350mA, TS (cathode point) temperature should be controlled below 85°C 所有高功率的发光LED产品安装在铝金属为核心印刷电路板, 可直接点亮, 但我们不建议在没有一个适当的散热设备时, 照明高功率LED点亮超过5秒, 当产品为700mA使用, TS点(负极焊盘)温度控制在 75°C 以下. 当产品为350mA使用, TS点(负极焊盘)温度控制在 85°C 以下.

4.wave peak and soak-stannum soldering etc.is not suitable for this products.波峰焊、浸锡焊接不适合这个产品

5.Reflow soldering should not be done more than two times.The reflow temperature we recommend is 260°C

回流焊不能超过两次, 回流焊最高温度建议 260°C 。

(2)Absolute Maximum Ratings 绝对最大额定值在 $T_A=25^{\circ}\text{C}$

Item名称	Symbol 符号	Absolute Maximum Rating 绝对最大额定值	Units单位
Power dissipation[1]功率	Pd	3	W
DC Forward Current[1]正向电流	I _F	700	mA
Peak Forward Current峰值电流	I _{FP}	800	mA
Reverse Voltage[1]方向电压	V _R	5	V
Operating Temperature 工作温度范围	Topr	-20°C To $+65^{\circ}\text{C}$	
Storage Temperature 储存温度范围	Tstg	0°C To $+40^{\circ}\text{C}$	

Note:

1.1/10 Duty Cycle,0.1ms Pulse Width.1 / 10占空比, 0.1ms脉冲宽度。

2.The temperature of Aluminum PCB do not exceed 55°C .基板温度不超过 55°C 。



Under Development	
Mass production	●

Typical Optical/Electrical Characteristics Curves 典型光学/电性特征曲线
($T_a=25^{\circ}\text{C}$ Unless Otherwise Noted) ($T_a=25^{\circ}\text{C}$ 除非另有注释)

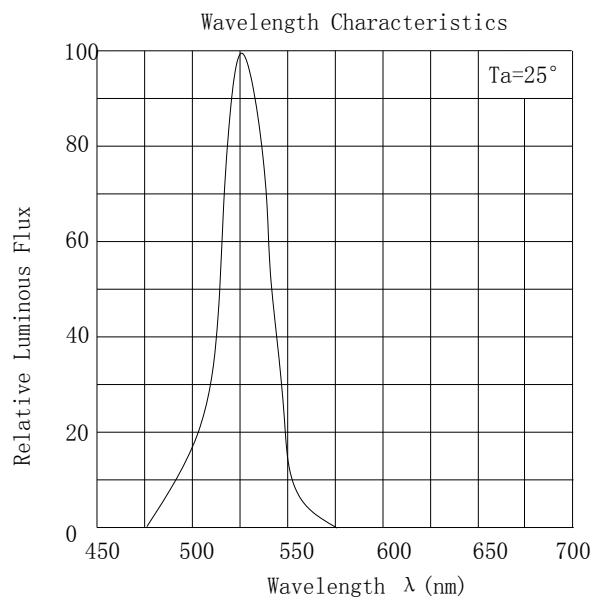
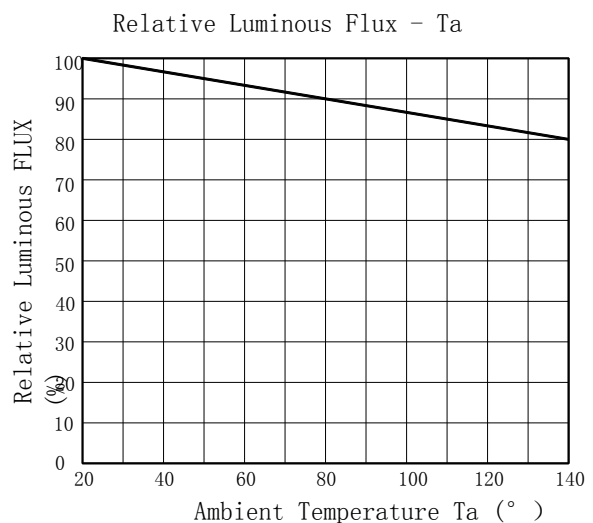
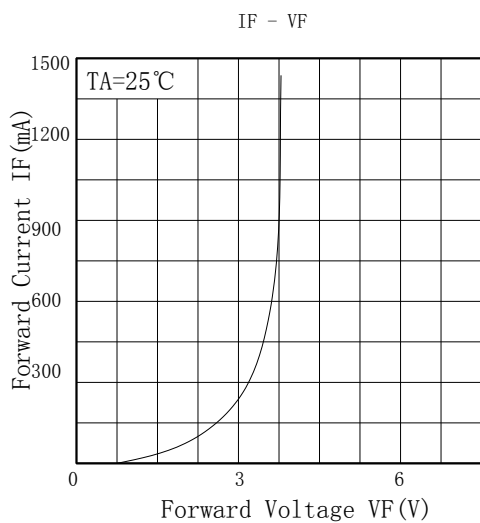
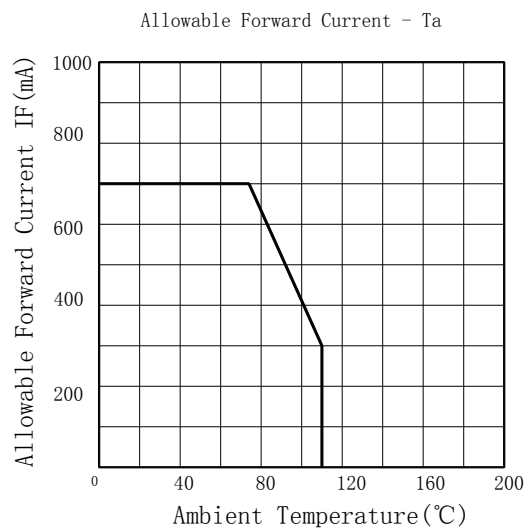
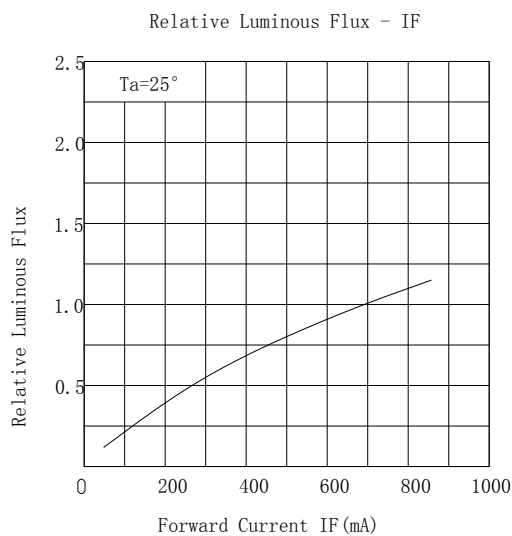



Under Development	
Mass production	●

Package Dimensions 封装尺寸

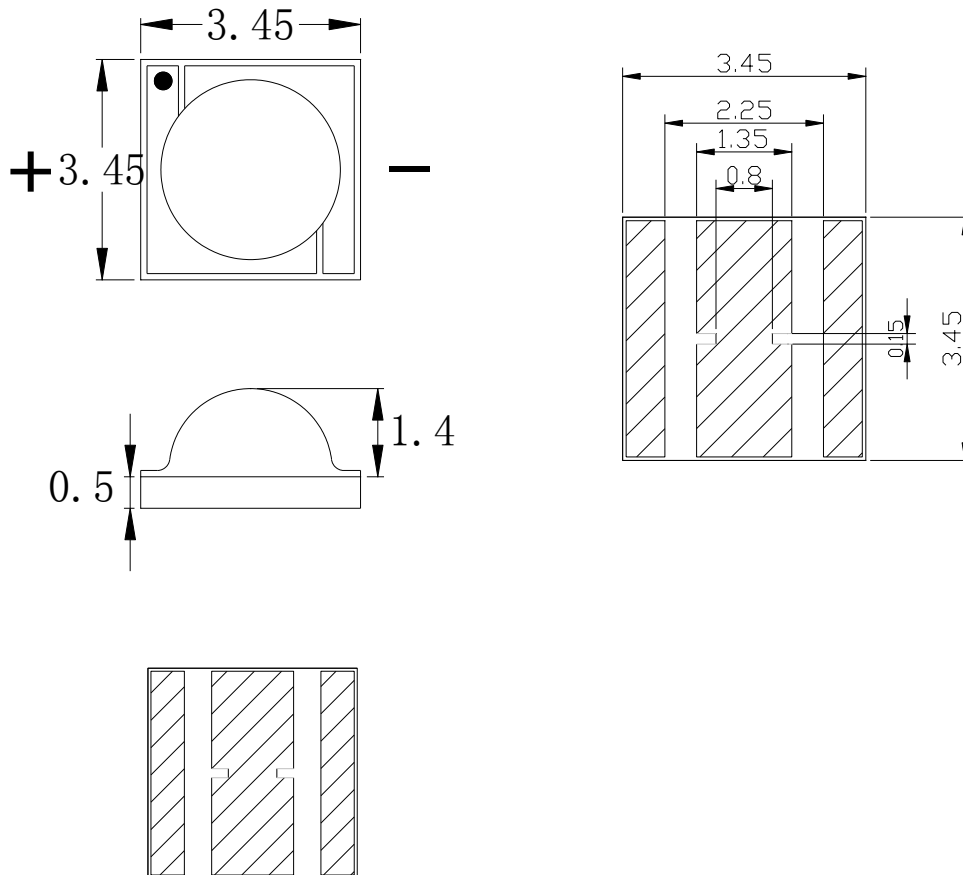

Notes 注意:

1. All dimension units are millimeters. 所有尺寸单位均为毫米.
2. All dimension tolerance is ±0.2mm unless otherwise noted. 所有尺寸误差是±0.2毫米除非另有说明

Label 标签

ΦV: Luminous Flux rank
光通量档次范围

VF: Forward voltage rank
正向电压档次范围

WD: Wave Length
波长

LOT.NO: Lot Number
批号

 HONGLITRONIC 鸿利光电		
TYPE:XXXXXXXXXXXX		QTY:XXX PCS
Bin:		
ΦV:	WD:	VF:
DATE:	LOT. NO:	



Under Development	
Mass production	●

Tape Specifications(Units:mm)包装规格 (单位:mm)

We provide tape as below 我们提供以下包装方式

Reel package (1000 pcs/reel) 卷轴包装 (1000 pcs/卷)

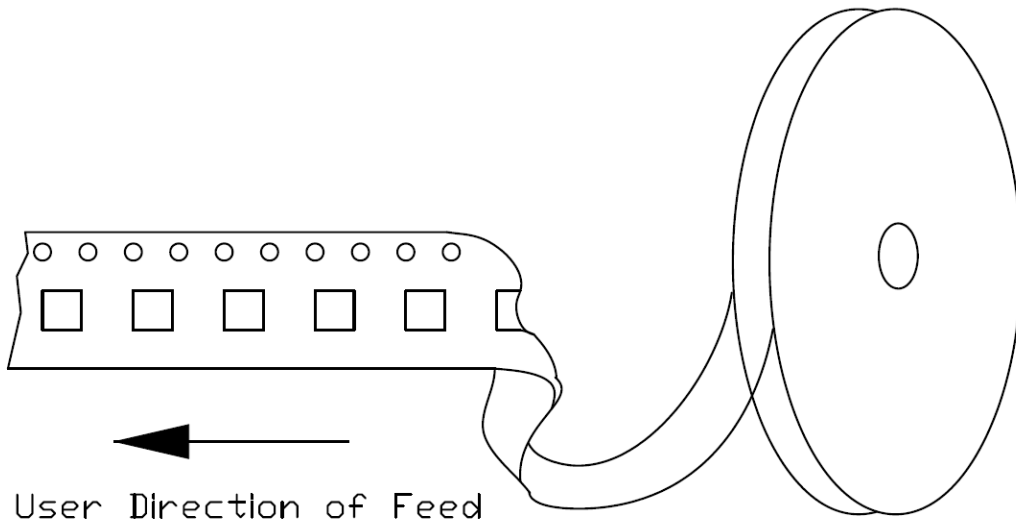
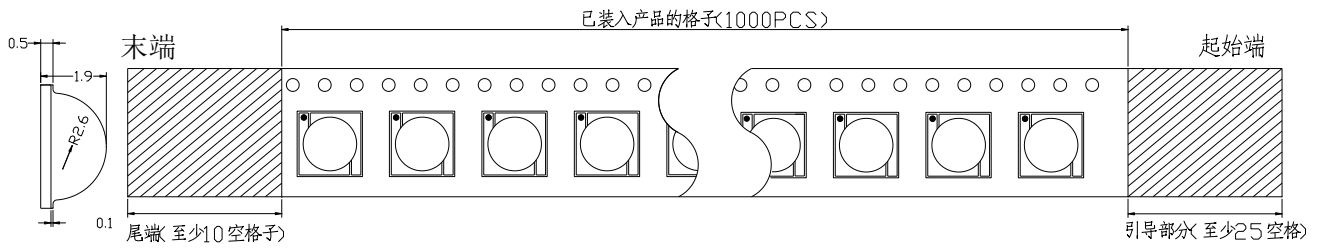

Moisture resistant packaging 防潮包装

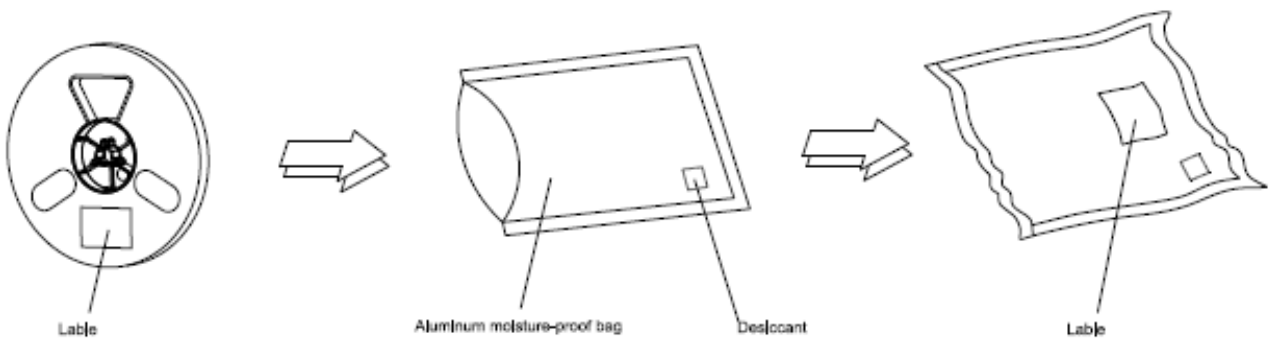



Reflow soldering instructions 回流焊说明

1. recommend to use a convection type reflow machine with 8 zones. 建议使用八温区回流焊机。
2. recommend to use Lead-Free Paste with a melting point between 230°C-240°C.
建议使用熔点为230°C-240°C的无铅锡膏
3. the reflow soldering time should not be more than 400s. 总的回流焊时间不要超过400s

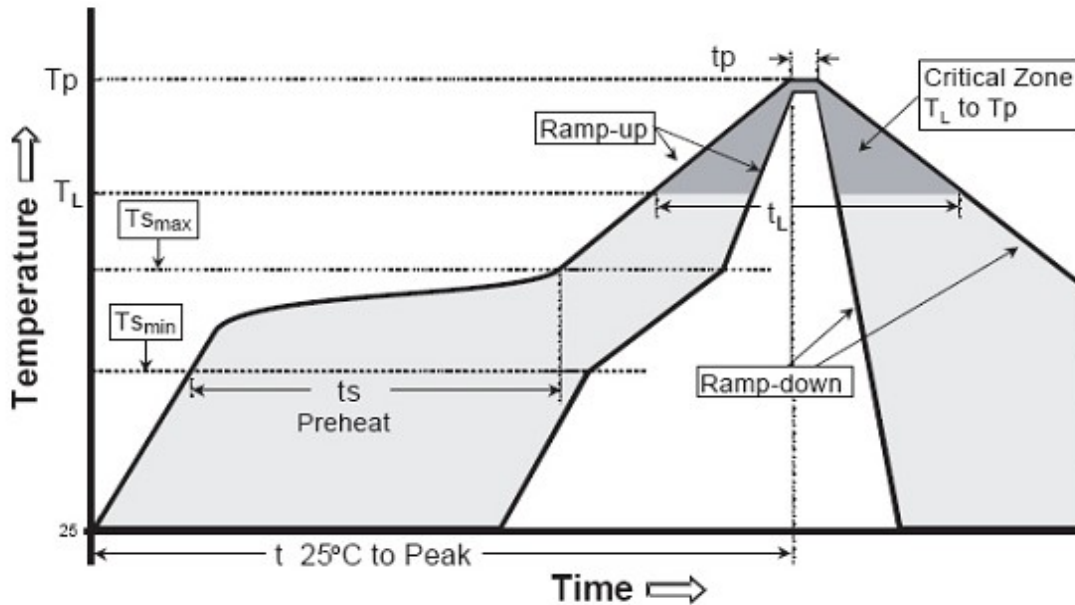

Profile Feature	Lead-Based solder	Lead-Free Solder
Average Ramp-Rate (T_{Smax} to T_p)	3°C/second max	3°C/second max
Preheat: Temperature Min (T_{Smin})	100°C	150°C
Preheat: Temperature Max (T_{Smax})	150°C	200°C
Preheat: Time (t_{Smin} to t_{Smax})	60-120 seconds	60-180 seconds
Time Maintained Above: Temperature (T_L)	183°C	217°C
Time Maintained Above: Time (t_L)	60-150 seconds	60-150 seconds
Peak/Classification Temperature (T_p)	215°C	260°C
Time Within 5°C of Actual Peak Temperature (t_p)	10-15 seconds	20-40 seconds
Ramp-Down Rate	6°C/second max	6°C/second max
Time 25°C to Peak Temperature	6 minutes max	8 minutes max



Under Development	
Mass production	●

Use the matters needing attention(使用注意事项)

一、储存(storage)：

为避免受潮的影响，我司建议产品在未开包装前储存条件为 5-30°C，相对湿度小于 60%；已开包装的 LED 光源请在 24H 内使用安装完毕，如未用完之产品，请进行除湿并抽真空后密封保存。开封超过一周或湿度卡发生变化时，请务必进行除湿，除湿条件：60°C±5°C，12H；

产品密封保存有效使用期为一年。

To avoid moisture, we recommend storage conditions for the unopened LED +5 ~ +30 °C, relative humidity <60%. LED should be used within 168 Hrs. of opening the package. Please make sure to dehumidify and vacuum pack the remaining/ unused LED. Dehumidifying condition: +120 ° C ± 5 ° C, 04 Hrs. Effective age for the sealed led is one year.

二、组装注意事项(the assembly notes)：

焊接条件：此产品必须使用回流焊接的作业方式，回流曲线最高温度不可超过 260°C。作业或存放过程中不可有 1000g 以上的外力或尖锐物体作用于透镜表面（如压力，摩擦等外力以及钳子镊子等工具），以免造成元件损伤；

如果超出此使用条件，鸿利光电将不能保证产品的稳定性，如需使用超出的操作条件，请务必进行风险评估。

Soldering Conditions : This product must be used reflow soldering practices, the maximum temperature of reflow should not exceed 260°C . Please make sure when soldering, there is no external force on the soldering surface (such as pressure, friction or sharp metal nails, etc.), to avoid gold wire deformation or damage and other abnormalities.

If beyond recommended conditions, we cannot guarantee the LED stability, please do the risk assessment first.

三、防静电措施(anti-Static Measures)：

请采取足够的措施来防止静电产生，比如带静电环或防静电手指套等；每个制造工程关于产品（工厂、设备、机器、载波机和运输单位）应当连接地面，避免产品电气带电。

Please take adequate measures to prevent electrostatic generation, such as wearing electrostatic ring or anti-static fingerstall etc; any relative products like plant equipment, machinery, carrier and transportation units shall be connected to discharging unit/ ground. After assembly, please make sure to discharge Static Electricity with proper ESD equipment.

四、温度控制(temperature Control)：

保证散热前提条件为：TS点（负极焊盘）为75/85摄氏度以下，在此温度以下，散热符合产品寿命要求；为确保在组装时降低接触热阻，请注意在组装过程中，散热片采用良好品质的导热膏涂布均匀且分布面积合理，不可出现太少或高低不平等现象。散热介质需保证电介质耐压测试至少通过500V。



Under Development	
Mass production	●

Recommended temperature conditions for enhanced product life: TS (Cathode Point) is <math><75/85^{\circ}\text{C}</math>. During assembly, please ensure that a good quality thermal paste is applied and distributed evenly over the surface. While using thermal pad (Heat Sink), make sure LED is firmly tightened and there is no gap between surfaces. The need to ensure the cooling medium dielectric withstand test at least through 500V.

五、驱动控制 (drive control):

本产品需使用恒流源进行驱动，且输出电流符合规格书上的功率使用范围，如需使用恒压源或其他使用条件，请进行使用效果风险评估。

Drive this product at constant current. Output current range specifications should be according to the operational and other conditions, as mentioned in data sheet. Before using a constant voltage source or altered specifications, other than recommended, please consider risk factors.

六、其他 (other):

本产品不可在以下条件下使用，如果产品在以下条件下使用，评估其使用效果和风险是有必要的：

- 直接或间接的打湿或受潮，比如淋雨等；
- 被海水损害或侵蚀；
- 被暴露于腐蚀性气体(如 Cl_2 , H_2S 、 NH_3 、 SO_x 、 NO_x 等) ；
- 被暴露于粉尘、液体或油；

Product is not suitable to use in following conditions;

- Direct or indirect wet / damp conditions, such as rain, etc;
- in contact with sea water and erosive materials;
- Exposed to corrosive gases (e.g., Cl_2 , H_2S , NH_3 , SO_x , NO_x , etc.);
- Exposed to dust, liquids or oils;



OK

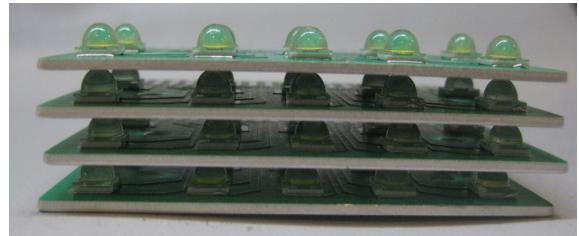

NG

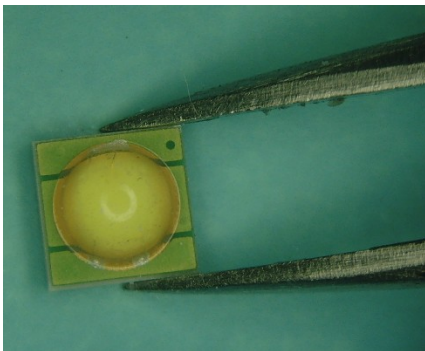

OK

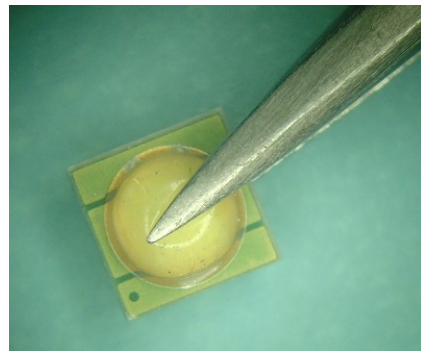

NG