



Under Development	
Mass production	●

RoHS

Specification

Client Name :
客户名称 : _____

Client P/N :
客户品号 : _____

Product P/N :
产品型号 : HL-EF32W1NAMS(Ra1)

Sending Date :
送样日期 : _____

Client approval 客户审核			Hongli approval 鸿利光电审核		
Approval 核准	Audit 确认	Confirmation 制作	Approval 核准	Audit 确认	Confirmation 制作
					陆旭秋
<input type="checkbox"/> Qualified 接受		<input type="checkbox"/> Disqualified 不接受		DATE: 日期:	

Adr : Airport High-tech Industry Base Jinggu South Road (XianKe 1st Road Inter-section), Huadu District, Guangzhou, China

地址 : 中国广州市花都区机场高科技产业基地金谷南路与先科一路交汇

Tel/电话 : 020-86733333

Fax/传真 : 020-86733883 86733938

注:1. 此规格书以中英文方式书写,若有冲突以中文版本为准文本.

2. 此规格书的最终解释权归广州市鸿利光电股份有限公司

3. 此规格书的有效期限为两年,自盖章或签字之日起计算,期满时双方可以续签协议,但应采用书面形式



Under Development	
Mass production	●



ATTENTION
OBSERVE PRECAUTIONS
FOR HANDLING
ELECTROSTATIC
DISCHARGE
SENSITIVE
DEVICES

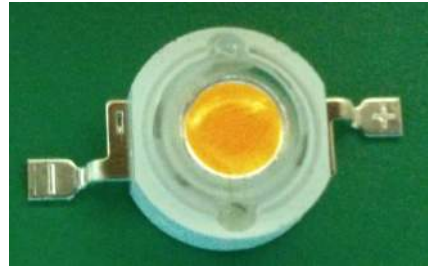

Features 特点

- Long operating life 寿命长
- High flux 光通量高
- More energy efficient than incandescent and most halogen lamps 比白炽灯与卤素灯节能
- Low voltage DC operated 低电压直流工作
- Cool beam, safe to the touch 冷光源，接触安全
- Instant light (less than 100ns) 瞬间点亮（小于100ns）
- Fully dimmable(属于可调光)
- No UV (无紫外线)
- Superior ESD protection(较好的防静电保护)
- RoHS compliant (符合RoHS标准)

Product naming rules 产品命名规则

E F32 W 1 N A M S (Ra1)
1 2 3 4 5 6 7 8 9

- 1：产品系列代码
- 2：芯片代码
- 3：表示发光颜色为白光
- 4：表示使用350mA分光
- 5：透镜代码
- 6：电路组合代码
- 7：支架代码
- 8：表示为硅胶工艺
- 9：表示Ra≥70

Applications 应用

- Portable lightings /(flash lightings, bicycle)便携式照明
- Spot lighting 射灯
- General lighting通用照明
- Other lighting 其他照明

Radiation Pattern 辐射模式

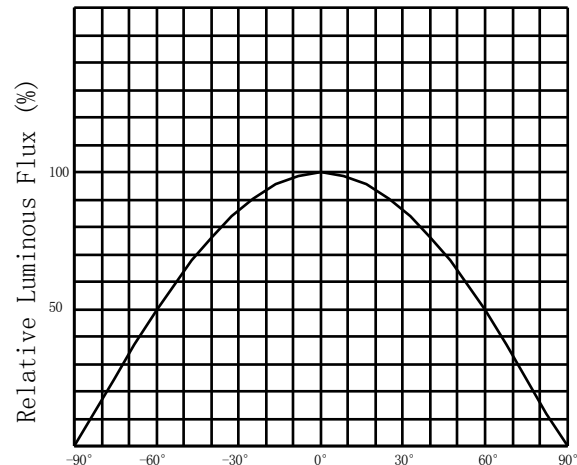
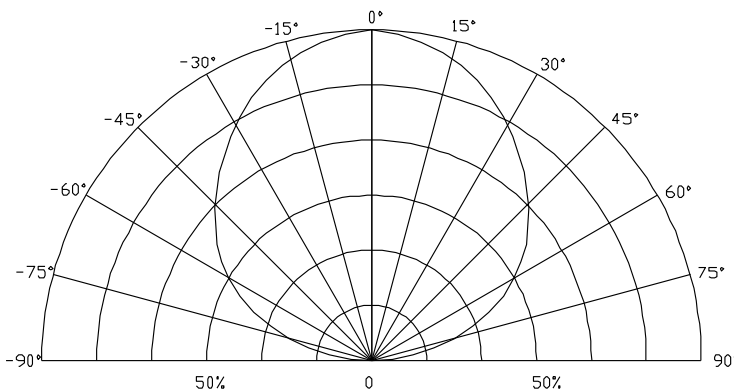



Specifications规范

(1) Absolute Maximum Ratings at Ta=25°C 在25°C时绝对极限条件

Parameter参数	Symbol符号	Rating 值	Units单位
Input power 输入功率	Pi	1.28	W
Forward Current 正向电流	IF	400	mA
Reverse Current反向电流	IR	10	uA
thermal resistance 热阻	Rth	11	°C/W
Junction Temperature结温	Tj	150	°C
Operating Temperature Range工作温度	Topr	-20°C To +85°C	
Storage Temperature Range储藏温度	Tstg	-40°C To +100°C	
Lead Soldering Temperature*引线焊接温度	Tsol	Max. 350°C for 3sec Max.	

Note :

- * All high power emitter LED products mounted on aluminum metal-core printed circuit board, can be lighted directly, but we do not recommend lighting the high power products for more than 5 seconds without a appropriate heat dissipation equipment. When using at 350mA, the temperature of copper pad should be controlled below 85°C 所有高功率的发光LED产品安装在铝金属为核心印刷电路板, 可直接点亮, 但我们不建议在没有一个适当的散热设备时, 照明高功率LED点亮超过5秒. 当产品为350mA使用, 铜柱温度控制在85°C以下.
- wave peak and soak-stannum soldering etc.is not suitable for this products.波峰焊、浸锡焊接不适合这个产品
- Reflow soldering should not be done more than two times.The reflow temperature we recommend is 210°C
回流焊不能超过两次, 回流焊最高温度建议210°C。

(2) Optical Characteristics at Ta=25°C IF=350mA

在Ta=25°C 时的典型光学特性 IF=350mA

HL-EF32W1NAMS(Ra1)						
Center Tc (K)	Tc (K)	Ra	Min (lm)	Typ (lm)	Luminous flux bins (lm)	
2725	2580-2870	70(min)	90	100	90-100	100-120
3045	2870-3220	70(min)	90	100	90-100	100-120
3985	3710-4260	70(min)	95	105	95-105	105-130
5028	4745-5310	70(min)	100	110	100-110	110-145
5665	5310-6020	70(min)	100	110	100-110	110-145
6020	5665-6530	70(min)	100	110	100-110	110-145
6530	6020-7040	70(min)	100	110	100-110	110-145

Notes注:

*1.the products after this specification refer to the parameters prevail, before the release of specification without refer to the above parameters.

此规格书发布日后生产的产品以上述参数为准, 发布前生产的库存品不参考上述参数。

2.Tolerance of measurement of forward voltage±3%、Color-rendering index±2、luminous flux±5%

不同标准源测试存在仪器公差: 正向电压公差为±3%、显指公差为±2、光通量公差为±5%。

(3) Optical Electrical /Thermal Characteristics at Ta=25° IF=350mA

在Ta=25°C 时典型的电学/热学特性IF=350mA

IF (mA)	VF (V)			R (j-s) (°C/W)	Po (W)
	min	typ	max		
350	3.0	3.2	3.6	11	1.1



Under Development	
Mass production	●

Product bins 产品分级

Forward Voltage bins 电压分级	Min (V)	Max (V)
	2.6	2.8
	2.8	3.0
	3.0	3.2
	3.2	3.4
	3.4	3.6

Chromaticity bins

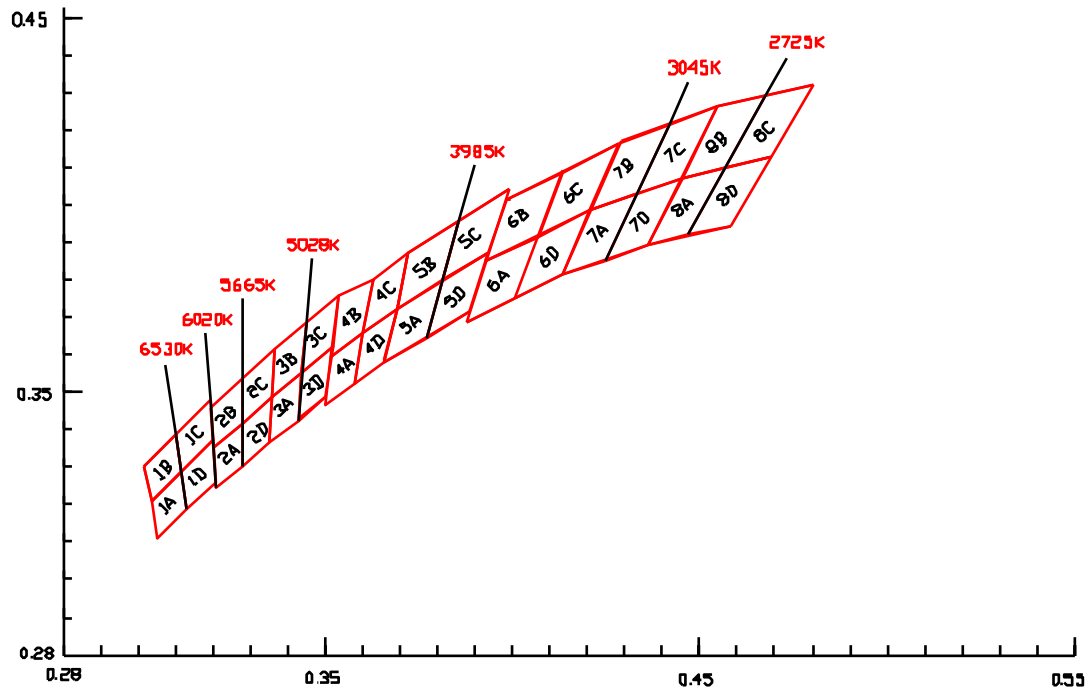

色温中心	2725K	3045K	3985K	5028K	5665K	6020K	6530K
X, Y	0.4578, 0.4101	0.4338, 0.403	0.3818, 0.3797	0.3447, 0.3553	0.329, 0.3417	0.3213, 0.3373	0.3123, 0.3282

Notes for Table

*1. Products are tested and binned at a transient forward current (IF) with 700mA. With the use of different IF, it may probably cause differences in CCT & forward voltage. Generally, with the increase of IF, the CCT will be raised as well.

该产品通过瞬态350mA 点亮, 分光分色. 若使用不同电流, 可能会引起色温及电压的变化, 一般情况下, 使用电流增加, 色温会上升。

2. Tolerance of ± 0.005 on x,y coordinates.

色坐标的测量误差允许在 ± 0.005

3. The chromaticity center refers to ANSI C78.377-2008

色温分bin参考ANSI C78.377-2008



Under Development	
Mass production	●

Typical Optical/Electrical Characteristics Curves 典型光学/电性特征曲线 ($T_a=25^{\circ}\text{C}$ Unless Otherwise Noted) ($T_a=25^{\circ}\text{C}$ 除非另有注释)

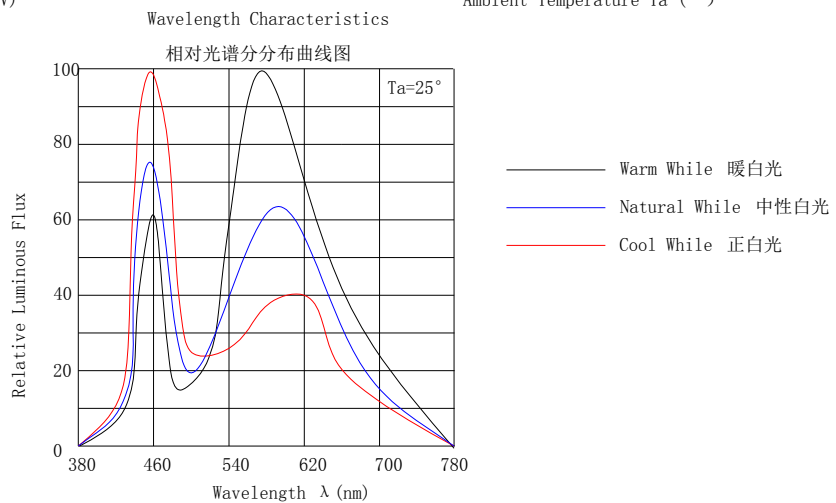
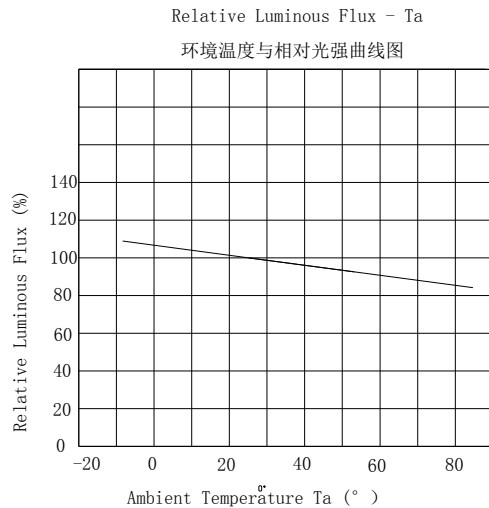
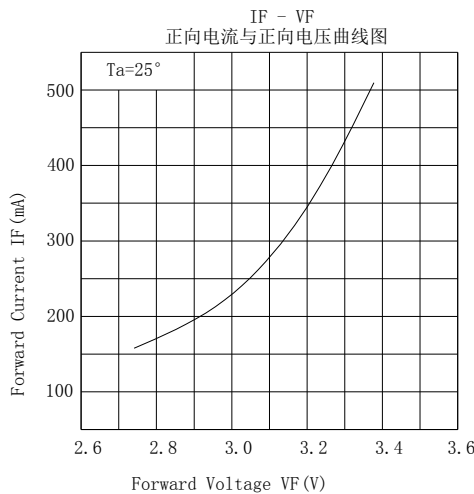
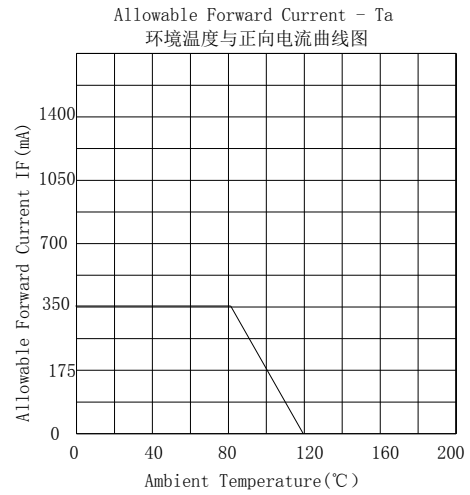
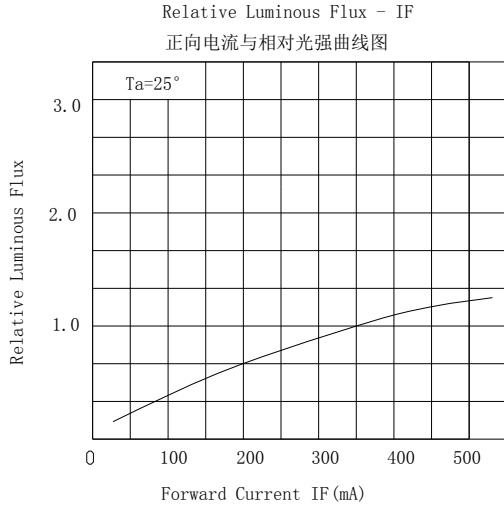



Under Development	
Mass production	●

Package Dimensions 封装尺寸

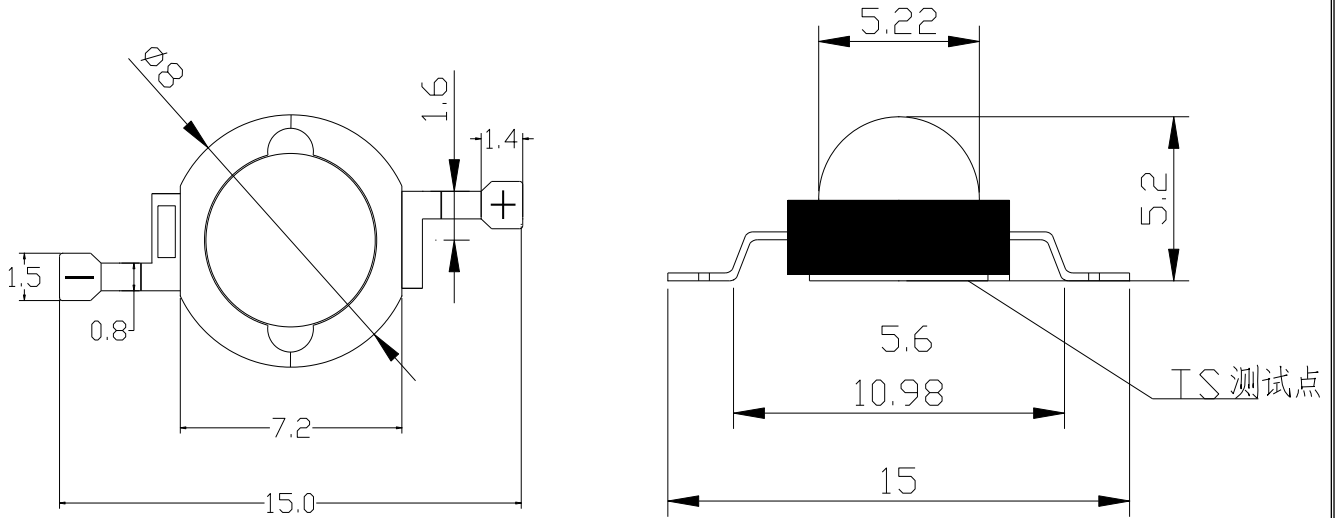

Notes 注意:

1. All dimension units are millimeters. 所有尺寸单位均为毫米.
2. All dimension tolerance is $\pm 0.2\text{mm}$ unless otherwise noted. 所有尺寸误差是 ± 0.2 毫米除非另有说明

Label 标签

ΦV : Luminous Flux rank
光通量档次范围

V_F : Forward voltage rank
正向电压档次范围

TC : Color temperature
色温

LOT.NO: Lot Number
批号

 HONGLITRONIC 鸿利光电		
TYPE:XXXXXXXXXXXX		QTY:XXX PCS
Bin:		
ΦV :	TC:	V_F :
DATE:	LOT. NO:	



Under Development	
Mass production	●

Tape Specifications(Units:mm)包装规格 (单位:mm)

We provide tape as below 我们提供以下包装方式

Tape by reel (suitable for automatic machine) 卷轴包装 (适用于自动贴片机)

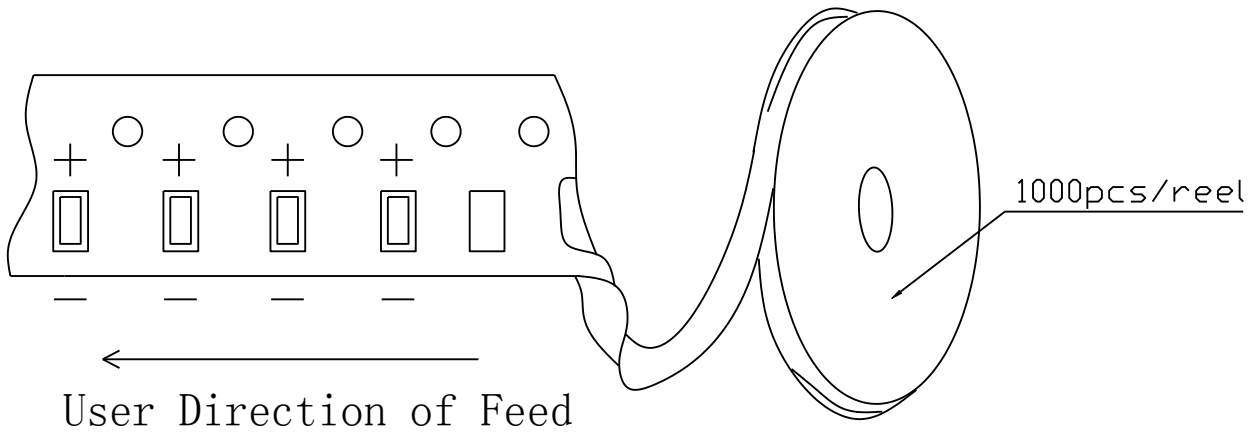
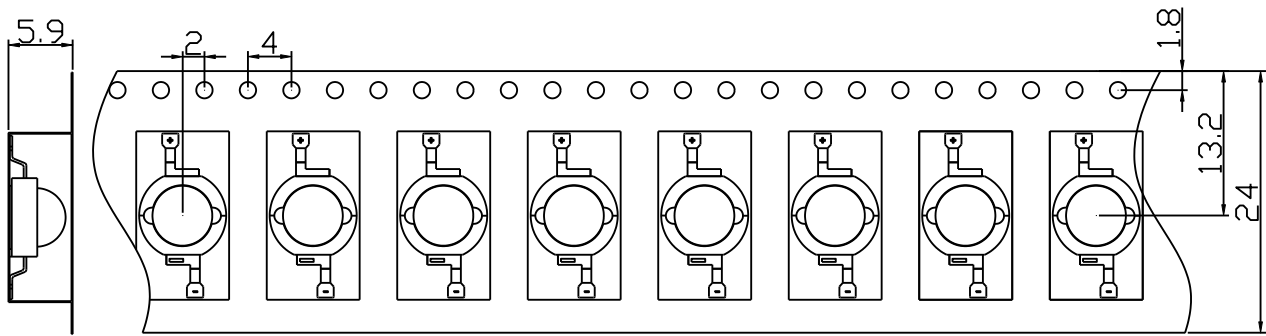

Moisture resistant packaging 防潮包装

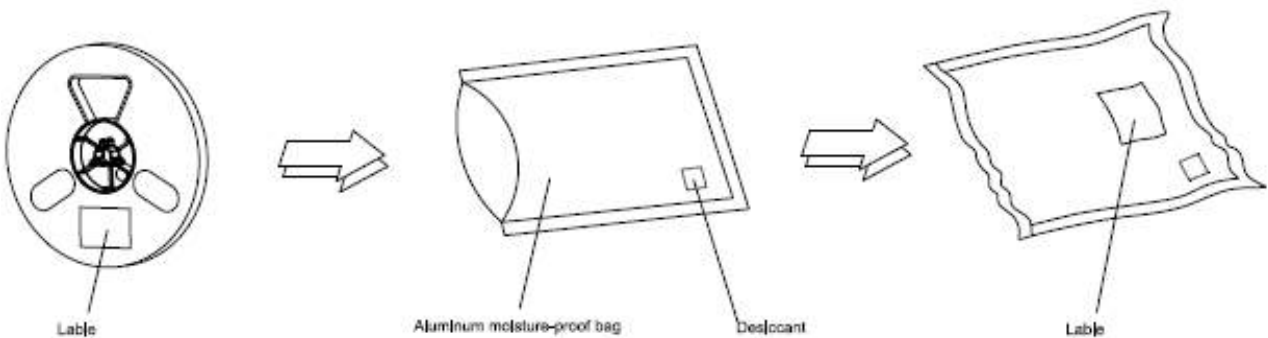



Reflow soldering instructions 回流焊说明

- 1.recommend to use a convection type reflow machine with 8 zones.建议使用八温区回流焊机。
- 2.recommend to use Lead-Free Paste with a melting point between 190°C-200°C.
建议使用熔点为190°C-200°C的无铅锡膏
- 3.the reflow soldering time should not be more than 400s.总的回流焊时间不要超过400s

Temperature-Time
温度-时间图

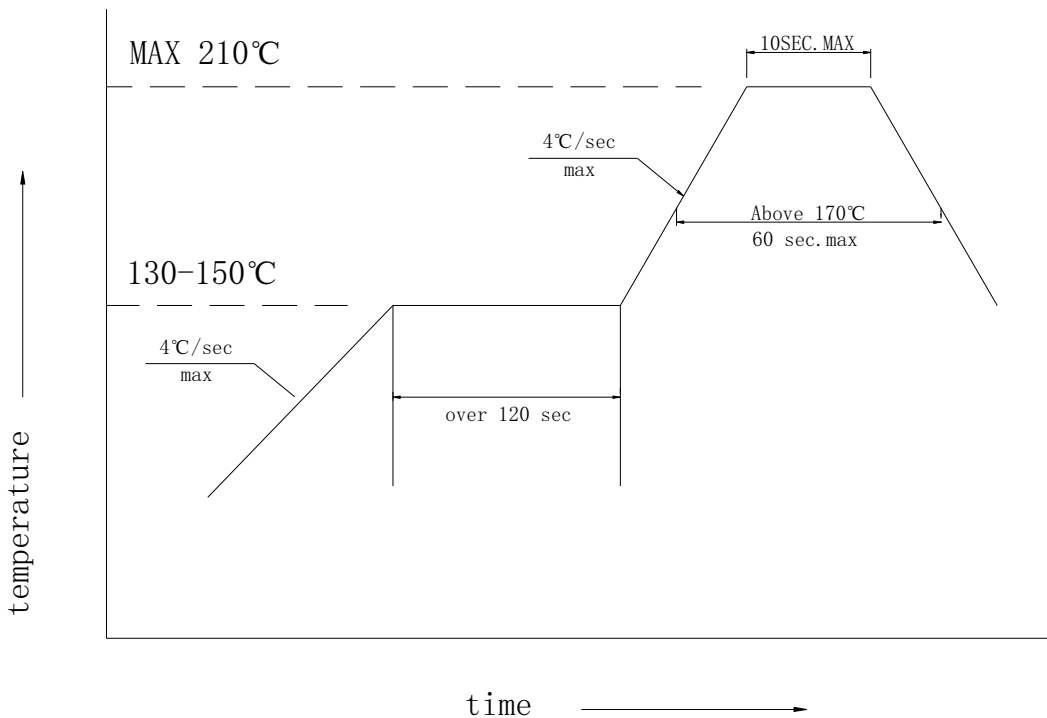

Recommend the temperature of each reflow machine zone 回流焊机每个温区建议使用的温度

第一温区/°C	第二温区/°C	第三温区/°C	第四温区/°C	第五温区/°C	第六温区/°C	第七温区/°C	第八温区/°C
120	135	150	165	180	195	210	180
时间/S	—	—	—	—	—	5-10S	—



Under Development	
Mass production	●

Use the matters needing attention(使用注意事项)

一、储存(storage)：

为避免受潮的影响，我司建议产品在未开包装前储存条件为 5-30℃，相对湿度小于 60%；已开包装的 LED 光源请在 24H 内使用安装完毕，如未用完之产品，请进行除湿并抽真空后密封保存。开封超过一周或湿度卡发生变化时，请务必进行除湿，除湿条件：60℃±5℃，12H；

产品密封保存有效使用期为一年。

To avoid moisture, we recommend storage conditions for the unopened LED +5 ~ +30 ℃, relative humidity <60%. LED should be used within 24 Hrs. of opening the package. Please make sure to dehumidify and vacuum pack the remaining/ unused LED. Dehumidifying condition: +60 ℃ ±5 ℃, 12 Hrs. Effective age for the sealed led is one year.

二、组装注意事项(the assembly notes)：

焊接条件：此产品推荐使用回流焊接的作业方式，回流曲线最高温度不可超过 210℃，（当产品为700mA 使用，请务必采用 铜柱底部焊接 的作业模式，如采用铜柱底部导热树脂模式，请自行评估寿命风险），如采用手工焊接，手工焊接烙铁温度设定 350℃，焊接时间不可超过 3 秒，第一焊点焊接后请确保基板表面温度恢复到环境温度，方可进行第二次的焊接；焊接完毕后请不要弯曲已焊 LED 的 PCB 板，清洗 PCB 板请使用洗板水手工擦拭，且不可直接用于于流体之中。

作业或存放过程中不可有 1000g 以上的外力或尖锐物体作用于透镜表面（如压力，摩擦等外力以及钳子镊子等工具），以免造成元件损伤；

如果超出此使用条件，鸿利光电将不能保证产品的稳定性，如需使用超出的操作条件，请务必进行风险评。另，型号含有“-LD”为路灯专用产品，组装条件请另行咨询。

Soldering Conditions: Reflow soldering is recommended for this LED, the maximum temperature of reflow should not exceed 210℃ (when using at 700mA, please adopt the soldering operation mode with copper pad at the bottom. Please consider the life time risk if use the thermal conductive resin with Copper pad at the bottom). If hand soldering, set soldering iron temperature at 350℃ and soldering time not More than 3 seconds, after the first soldering, make sure the substrate surface temperature returns to ambient temperature before a second soldering. Do not bend the LED PCB after soldering. Use recommended cleaning agent for PCB cleaning (Should not be use directly in the fluid)

Please make sure when soldering, there is no external force on the soldering surface (such as pressure, friction or sharp metal nails, etc.), to avoid gold wire deformation or damage and other abnormalities. If beyond recommended conditions, we cannot guarantee the LED stability, please do the risk assessment first.

三、防静电措施(anti-Static Measures)：

请采取足够的措施来防止静电产生，比如带静电环或防静电手指套等；每个制造工程关于产品（工厂、设备、机器、载波机和运输单位）应当连接地面，避免产品电气带电。

Please take adequate measures to prevent electrostatic generation, such as wearing electrostatic ring or anti-static fingerstall etc; any relative products like plant equipment, machinery, carrier and transportation units shall be connected to discharging unit/ ground. After assembly, please make sure to discharge Static Electricity with proper ESD equipment.

四、温度控制(temperature Control)：

保证散热前提条件为：支架铜柱温度为85度以下，在此温度以下，散热符合产品寿命要求；为确保在组装时降低接触热阻，请注意底部锡膏焊接或导热膏涂布均匀且分布面积合理，不可出现太少或高低不平等现象。以上散热介质需保证电介质耐压测试至少通过500V。



Under Development	
Mass production	●

Recommended temperature conditions for enhanced product life: The temperature of copper pad is <math><85^{\circ}\text{C}</math>. During assembly, please ensure that a good quality thermal paste is applied and distributed evenly over the surface. While using thermal pad (Heat Sink), make sure LED is firmly tightened and there is no gap between surfaces. This product Heating conditions, tested at 500V with medium surface contact.

五、驱动控制(drive control)：

本产品需使用恒流源进行驱动，且输出电流符合规格书上的功率使用范围，如需使用恒压源或其他使用条件，请进行使用效果风险评估。

Drive this product at constant current. Output current range specifications should be according to the operational and other conditions, as mentioned in data sheet. Before using a constant voltage source or altered specifications, other than recommended, please consider risk factors.

六、其他(other)：

本产品不可在以下条件下使用，如果产品在以下条件下使用，评估其使用效果和风险是有必要的：

- 直接或间接的打湿或受潮，比如淋雨等；
- 被海水损害或侵蚀；
- 被暴露于腐蚀性气体(如 Cl_2 , H_2S 、 NH_3 、 SO_x 、 NO_x 等)；
- 被暴露于粉尘、液体或油；

Product is not suitable to use in following conditions;

- Direct or indirect wet / damp conditions, such as rain, etc;
- in contact with sea water and erosive materials;
- Exposed to corrosive gases (e.g., Cl_2 , H_2S , NH_3 , SO_x , NO_x , etc.);
- Exposed to dust, liquids or oils;



OK



NG