

## LM2936 Ultra-Low Quiescent Current LDO Voltage Regulator

### 1 Features

- LM2936 Operating  $V_{IN}$  range of 5.5 V to 40 V
- LM2936HV Operating  $V_{IN}$  range of 5.5 V to 60 V
- Ultra Low Quiescent Current ( $I_Q \leq 15 \mu\text{A}$  for  $I_{OUT} = 100 \mu\text{A}$ )
- Fixed 3-V, 3.3-V or 5-V with 50-mA Output
- $\pm 2\%$  Initial Output Tolerance
- $\pm 3\%$  Output Tolerance Over Line, Load, and Temperature
- Dropout Voltage Typically 200 mV at  $I_{OUT} = 50 \text{ mA}$
- $-24\text{-V}$  Input Voltage Protection
- $-50\text{-V}$  Input Transient Protection
- Internal Short Circuit Current Limit
- Internal Thermal Shutdown Protection
- Shutdown Pin Available with LM2936BM Package

### 2 Applications

- Automotive
- Industrial Controls
- Point of Load

### 3 Description

The LM2936 ultra-low quiescent current regulator features low dropout voltage and low current in the standby mode. With less than  $15\text{-}\mu\text{A}$  quiescent current at a  $100\text{-}\mu\text{A}$  load, the LM2936 is ideally suited for automotive and other battery operated systems. The LM2936 retains all of the features that are common to low dropout regulators including a low dropout PNP pass device, short circuit protection, reverse battery protection, and thermal shutdown. The LM2936 has a  $40\text{-V}$  maximum operating voltage limit, a  $-40^\circ\text{C}$  to  $125^\circ\text{C}$  operating temperature range, and  $\pm 3\%$  output voltage tolerance over the entire output current, input voltage, and temperature range. The LM2936 is available in a TO-92 through-hole package, as well as SOIC-8, VSSOP, SOT-223, and TO-252 surface mount packages.

#### Device Information<sup>(1)</sup>

PART NUMBER	PACKAGE	BODY SIZE (NOM)
LM2936	SOIC (8)	4.90 mm x 3.91 mm
	TO-252 (3)	6.10 mm x 6.58 mm
	VSSOP (8)	3.00 mm x 3.00 mm
	SOT-223 (4)	6.50 mm x 3.50 mm
	TO-92 (3)	4.30 mm x 4.30 mm

(1) For all available packages, see the orderable addendum at the end of the datasheet.

#### Simplified Schematic

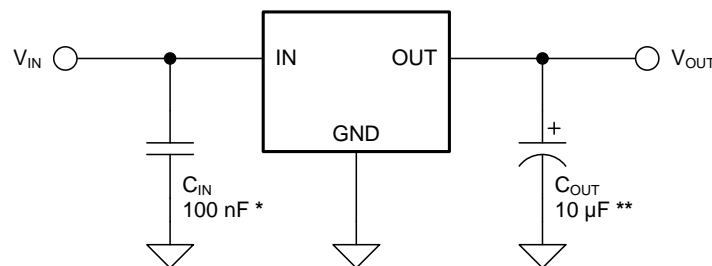

\* Required if regulator is located more than 2" from power supply filter capacitor.

\*\* Required for stability. See [Electrical Characteristics for 3-V LM2936](#) for required values. Must be rated over intended operating temperature range. Effective series resistance (ESR) is critical, see [Typical Characteristics](#). Locate capacitor as close as possible to the regulator output and ground pins. Capacitance may be increased without bound.



## Table of Contents

<b>1 Features</b> ..... 1 <b>2 Applications</b> ..... 1 <b>3 Description</b> ..... 1 <b>4 Revision History</b> ..... 2 <b>5 Pin Configuration and Functions</b> ..... 3 <b>6 Specifications</b> ..... 4 6.1 Absolute Maximum Ratings ..... 4 6.2 ESD Ratings ..... 4 6.3 Recommended Operating Conditions ..... 4 6.4 Thermal Information ..... 4 6.5 Electrical Characteristics for 3-V LM2936 ..... 5 6.6 Electrical Characteristics for 3.3-V LM2936 ..... 6 6.7 Electrical Characteristics for 5-V LM2936 ..... 7 6.8 Typical Characteristics ..... 8 <b>7 Detailed Description</b> ..... 12 7.1 Overview ..... 12 7.2 Functional Block Diagram ..... 12	7.3 Feature Description ..... 12 7.4 Device Functional Modes ..... 13 <b>8 Application and Implementation</b> ..... 14 8.1 Application Information ..... 14 8.2 Typical Application ..... 14 <b>9 Power Supply Recommendations</b> ..... 15 <b>10 Layout</b> ..... 16 10.1 Layout Guidelines ..... 16 10.2 Layout Examples ..... 16 10.3 Thermal Considerations ..... 16 <b>11 Device and Documentation Support</b> ..... 18 11.1 Documentation Support ..... 18 11.2 Trademarks ..... 18 11.3 Electrostatic Discharge Caution ..... 18 11.4 Glossary ..... 18 <b>12 Mechanical, Packaging, and Orderable Information</b> ..... 18
--	---

## 4 Revision History

NOTE: Page numbers for previous revisions may differ from page numbers in the current version.

Changes from Revision N (March 2013) to Revision O	Page
<ul style="list-style-type: none"> <li>• Added <i>Pin Configuration and Functions</i> section, <i>ESD Rating</i> table, <i>Feature Description</i> section, <i>Device Functional Modes</i>, <i>Application and Implementation</i> section, <i>Power Supply Recommendations</i> section, <i>Layout</i> section, <i>Device and Documentation Support</i> section, and <i>Mechanical, Packaging, and Orderable Information</i> section ..... 1</li> </ul>	1

Changes from Revision M (March 2013) to Revision N	Page
<ul style="list-style-type: none"> <li>• Changed layout of National Data Sheet to TI format ..... 13</li> </ul>	13

## 5 Pin Configuration and Functions

LM2936DT TO-252 (NDP) Package  
3-Pins  
Top View

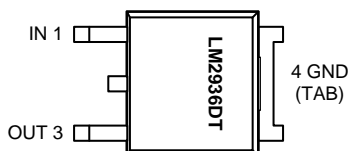

LM2936MP SOT-223 (DCY) Package  
4-Pins  
Top View



LM2936BM SOIC (D) Package  
8-Pins  
Top View



LM2936M SOIC (D) Package  
8-Pins  
Top View

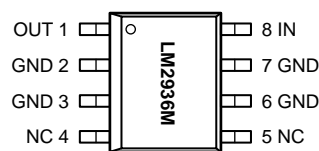

LM2936Z TO-92 (LP) Package  
3-Pins  
Bottom View

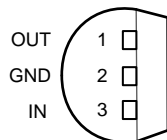

LM2936MM VSSOP (DGK) Package  
8-Pins  
Top View

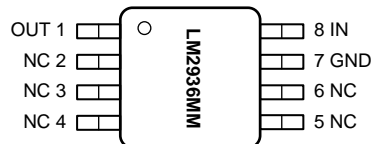

### Pin Functions

NAME	PIN						I/O	DESCRIPTION
	D (LM2936BM)	D (LM2936M)	NDP	DGK	DCY	LP		
IN	8	8	1	8	1	3	I	Unregulated input voltage.
GND	2, 3, 6, 7	2, 3, 6, 7	4	7	2, 4	2	—	Ground.
OUT	1	1	3	1	3	1	O	Regulated output voltage. Requires a minimum output capacitance, with specific ESR, on this pin to maintain stability.
SD	5	—	—	—	—	—	I	Shutdown. LM2936BM only. Pull this pin HIGH (> 2 V) to turn the output OFF. If this pin is left open, pulled low (< 0.6 V), or connected to GND, the output will be ON by default. Avoid having any voltage between 0.6 V and 2 V on this pin as the output status may not be predictable across the operating range.
NC	4	4, 5	—	2, 3, 4, 5, 6	—	—	—	No internal connection, Connect to GND, or leave open.

## 6 Specifications

### 6.1 Absolute Maximum Ratings <sup>(1)(2)</sup>

	MIN	MAX	UNIT
Input voltage (survival)	-50	60	V
Power dissipation <sup>(3)</sup>	Internally limited		
Junction temperature ( $T_{J(MAX)}$ )		150	°C
Storage temperature, $T_{stg}$	-65	150	

- (1) *Absolute Maximum Ratings* indicate limits beyond which damage to the device may occur. DC and AC electrical specifications do not apply when operating the device beyond its specified operating ratings.
- (2) If Military/Aerospace specified devices are required, please contact the TI Sales Office/ Distributors for availability and specifications.
- (3) The maximum power dissipation is a function of  $T_{J(MAX)}$ ,  $R_{\theta JA}$ , and  $T_A$ . The maximum allowable power dissipation at any ambient temperature is  $P_D = (T_{J(MAX)} - T_A) / R_{\theta JA}$ . If this dissipation is exceeded, the die temperature can rise above the  $T_{J(MAX)}$  of 150°C, and the LM2936 may go into thermal shutdown.

### 6.2 ESD Ratings

	VALUE	UNIT
$V_{(ESD)}$ Electrostatic discharge Human-body model (HBM), per ANSI/ESDA/JEDEC JS-001 <sup>(1)</sup>	±2000	V

- (1) JEDEC document JEP155 states that 500-V HBM allows safe manufacturing with a standard ESD control process. .

### 6.3 Recommended Operating Conditions

	MIN	MAX	UNIT
Temperature, $T_J$	-40	125	°C
Input voltage, $V_{IN}$ , LM2936	5.5	40	V
Input voltage, $V_{IN}$ , LM2936HV only	5.5	60	V
Shutdown pin voltage, $V_{SD}$ , LM2936BM only	0	40	V

### 6.4 Thermal Information

THERMAL METRIC <sup>(1)</sup>	LM2936					UNIT
	SOIC (D)	TO-252 (NDP)	VSSOP (DGK)	SOT-223 (DCY)	TO-92 (LP)	
	8 PINS	3 PINS	8 PINS	4 PINS	3 PINS	
$R_{\theta JA}$ Junction-to-ambient thermal resistance	111.4	50.5	173.4	62.8	156.8	°C/W
$R_{\theta JC(top)}$ Junction-to-case (top) thermal resistance	56.3	52.6	65.9	44.2	80.4	
$R_{\theta JB}$ Junction-to-board thermal resistance	51.9	29.7	94.9	11.7	n/a	
$\psi_{JT}$ Junction-to-top characterization parameter	10.9	4.8	9.6	3.6	24.5	
$\psi_{JB}$ Junction-to-board characterization parameter	51.4	29.3	93.3	11.6	136.0	
$R_{\theta JC(bot)}$ Junction-to-case (bottom) thermal resistance	n/a	1.6	n/a	n/a	n/a	

- (1) For more information about traditional and new thermal metrics, see the *IC Package Thermal Metrics* application report, [SPRA953](#).

## 6.5 Electrical Characteristics for 3-V LM2936

 $V_{IN} = 14\text{ V}$ ,  $I_{OUT} = 10\text{ mA}$ ,  $T_J = 25^\circ\text{C}$ , unless otherwise specified.

PARAMETER	TEST CONDITIONS	MIN <sup>(1)</sup>	TYP <sup>(2)</sup>	MAX <sup>(1)</sup>	UNIT
<b>3-V LM2936HV ONLY</b>					
Output voltage	$5.5\text{ V} \leq V_{IN} \leq 48\text{ V}$ , $100\ \mu\text{A} \leq I_{OUT} \leq 50\text{ mA}$ , <sup>(2)</sup> $-40^\circ\text{C} \leq T_J \leq 125^\circ\text{C}$	2.91	3	3.09	V
Line regulation	$6\text{ V} \leq V_{IN} \leq 60\text{ V}$ , $I_{OUT} = 1\text{ mA}$		10	30	mV
<b>ALL 3-V LM2936</b>					
Output voltage		2.94	3	3.06	V
	$4\text{ V} \leq V_{IN} \leq 26\text{ V}$ , $100\ \mu\text{A} \leq I_{OUT} \leq 50\text{ mA}$ , <sup>(2)</sup> $-40^\circ\text{C} \leq T_J \leq 125^\circ\text{C}$	2.91	3.000	3.09	
Quiescent current	$I_{OUT} = 100\ \mu\text{A}$ , $8\text{ V} \leq V_{IN} \leq 24\text{ V}$		15	20	$\mu\text{A}$
	$I_{OUT} = 10\text{ mA}$ , $8\text{ V} \leq V_{IN} \leq 24\text{ V}$		0.2	0.5	mA
	$I_{OUT} = 50\text{ mA}$ , $8\text{ V} \leq V_{IN} \leq 24\text{ V}$		1.5	2.5	mA
Line regulation	$9\text{ V} \leq V_{IN} \leq 16\text{ V}$		5	10	mV
	$6\text{ V} \leq V_{IN} \leq 40\text{ V}$ , $I_{OUT} = 1\text{ mA}$		10	30	
Load regulation	$100\ \mu\text{A} \leq I_{OUT} \leq 5\text{ mA}$		10	30	mV
	$5\text{ mA} \leq I_{OUT} \leq 50\text{ mA}$		10	30	
Dropout voltage	$I_{OUT} = 100\ \mu\text{A}$		0.05	0.1	V
	$I_{OUT} = 50\text{ mA}$		0.20	0.40	V
Short-circuit current	$V_{OUT} = 0\text{ V}$	65	120	250	mA
Output impedance	$I_{OUT} = 30\text{ mAdc}$ and $10\text{ mArms}$ , $f = 1000\text{ Hz}$		450		$\text{m}\Omega$
Output noise voltage	10 Hz–100 kHz		500		$\mu\text{V}$
Long-term stability			20		mV/1000 Hr
Ripple rejection	$V_{\text{ripple}} = 1\text{ V}_{\text{rms}}$ , $f_{\text{ripple}} = 120\text{ Hz}$	-40	-60		dB
Reverse polarity transient input voltage	$R_L = 500\ \Omega$ , $t = 1\text{ ms}$	-50	-80		V
Output voltage with reverse polarity input	$V_{IN} = -15\text{ V}$ , $R_L = 500\ \Omega$		0	-0.3	V
Maximum Line Transient	$R_L = 500\ \Omega$ , $V_{OUT} \leq 3.3\text{ V}$ , $T = 40\text{ ms}$	60			V
Output bypass capacitance ( $C_{OUT}$ ) ESR	$C_{OUT} = 22\ \mu\text{F}$ , $0.1\text{ mA} \leq I_{OUT} \leq 50\text{ mA}$	0.3		8	$\Omega$
<b>SHUTDOWN INPUT – 3-V LM2936BM ONLY</b>					
Output voltage, $V_{OUT}$	Output off, $V_{SD} = 2.4\text{ V}$ , $R_{LOAD} = 500\ \Omega$		0	0.01	V
Shutdown high threshold voltage, $V_{IH}$	Output off, $R_{LOAD} = 500\ \Omega$	2	1.1		V
Shutdown low threshold voltage, $V_{IL}$	Output on, $R_{LOAD} = 500\ \Omega$		1.1	0.6	V
Shutdown high current, $I_{IH}$	Output off, $V_{SD} = 2.4\text{ V}$ , $R_{LOAD} = 500\ \Omega$		12		$\mu\text{A}$
Quiescent current	Output off, $V_{SD} = 2.4\text{ V}$ , $R_{LOAD} = 500\ \Omega$ , includes $I_{IH}$ current		30		$\mu\text{A}$

(1) Datasheet min/max specification limits are ensured by design, test, or statistical analysis.

(2) Typicals are at  $25^\circ\text{C}$  (unless otherwise specified) and represent the most likely parametric norm.

## 6.6 Electrical Characteristics for 3.3-V LM2936

 $V_{IN} = 14\text{ V}$ ,  $I_{OUT} = 10\text{ mA}$ ,  $T_J = 25^\circ\text{C}$ , unless otherwise specified.

PARAMETER	TEST CONDITIONS	MIN <sup>(1)</sup>	TYP <sup>(2)</sup>	MAX <sup>(1)</sup>	UNIT
<b>3.3-V LM2936HV ONLY</b>					
Output voltage	$5.5\text{ V} \leq V_{IN} \leq 48\text{ V}$ , $100\text{ }\mu\text{A} \leq I_{OUT} \leq 50\text{ mA}$ , <sup>(3)</sup> $-40^\circ\text{C} \leq T_J \leq 125^\circ\text{C}$	3.201	3.300	3.399	V
Line regulation	$6\text{ V} \leq V_{IN} \leq 60\text{ V}$ , $I_{OUT} = 1\text{ mA}$		10	30	mV
<b>ALL 3.3-V LM2936</b>					
Output voltage	$4\text{ V} \leq V_{IN} \leq 26\text{ V}$ , $100\text{ }\mu\text{A} \leq I_{OUT} \leq 50\text{ mA}$ , <sup>(3)</sup> $-40^\circ\text{C} \leq T_J \leq 125^\circ\text{C}$	3.234	3.300	3.366	V
Quiescent current	$I_{OUT} = 100\text{ }\mu\text{A}$ , $8\text{ V} \leq V_{IN} \leq 24\text{ V}$		15	20	
	$I_{OUT} = 10\text{ mA}$ , $8\text{ V} \leq V_{IN} \leq 24\text{ V}$		0.2	0.5	mA
	$I_{OUT} = 50\text{ mA}$ , $8\text{ V} \leq V_{IN} \leq 24\text{ V}$		1.5	2.5	mA
Line regulation	$9\text{ V} \leq V_{IN} \leq 16\text{ V}$		5	10	mV
	$6\text{ V} \leq V_{IN} \leq 40\text{ V}$ , $I_{OUT} = 1\text{ mA}$		10	30	
Load regulation	$100\text{ }\mu\text{A} \leq I_{OUT} \leq 5\text{ mA}$		10	30	mV
	$5\text{ mA} \leq I_{OUT} \leq 50\text{ mA}$		10	30	
Dropout voltage	$I_{OUT} = 100\text{ }\mu\text{A}$		0.05	0.10	V
	$I_{OUT} = 50\text{ mA}$		0.2	0.4	V
Short-circuit current	$V_{OUT} = 0\text{ V}$	65	120	250	mA
Output impedance	$I_{OUT} = 30\text{ mAdc}$ and $10\text{ mArms}$ , $f = 1000\text{ Hz}$		450		$\text{m}\Omega$
Output noise voltage	10 Hz–100 kHz		500		$\mu\text{V}$
Long-term stability			20		mV/1000 Hr
Ripple rejection	$V_{\text{ripple}} = 1\text{ V}_{\text{rms}}$ , $f_{\text{ripple}} = 120\text{ Hz}$	-40	-60		dB
Reverse polarity transient input voltage	$R_L = 500\text{ }\Omega$ , $T = 1\text{ ms}$	-50	-80		V
Output voltage with reverse polarity input	$V_{IN} = -15\text{ V}$ , $R_L = 500\text{ }\Omega$		0	-0.3	V
maximum line transient	$R_L = 500\text{ }\Omega$ , $V_{OUT} \leq 3.63\text{ V}$ , $T = 40\text{ ms}$	60			V
Output bypass capacitance ( $C_{OUT}$ ) ESR	$C_{OUT} = 22\text{ }\mu\text{F}$ , $0.1\text{ mA} \leq I_{OUT} \leq 50\text{ mA}$	0.3		8	$\Omega$
<b>SHUTDOWN INPUT – 3.3-V LM2936BM ONLY</b>					
Output voltage, $V_{OUT}$	Output off, $V_{SD} = 2.4\text{ V}$ , $R_{LOAD} = 500\text{ }\Omega$		0	0.01	V
Shutdown high threshold voltage, $V_{IH}$	Output off, $R_{LOAD} = 500\text{ }\Omega$	2	1.1		V
Shutdown low threshold voltage, $V_{IL}$	Output on, $R_{LOAD} = 500\text{ }\Omega$		1.1	0.6	V
Shutdown high current, $I_{IH}$	Output off, $V_{SD} = 2.4\text{ V}$ , $R_{LOAD} = 500\text{ }\Omega$		12		$\mu\text{A}$
Quiescent current	Output off, $V_{SD} = 2.4\text{ V}$ , $R_{LOAD} = 500\text{ }\Omega$ , includes $I_{IH}$ current		30		$\mu\text{A}$

(1) Datasheet min/max specification limits are ensured by design, test, or statistical analysis.

(2) Typicals are at  $25^\circ\text{C}$  (unless otherwise specified) and represent the most likely parametric norm.

(3) To ensure constant junction temperature, pulse testing is used.

## 6.7 Electrical Characteristics for 5-V LM2936

 $V_{IN} = 14\text{ V}$ ,  $I_{OUT} = 10\text{ mA}$ ,  $T_J = 25^\circ\text{C}$ , unless otherwise specified.

PARAMETER	TEST CONDITIONS	MIN <sup>(1)</sup>	TYP <sup>(2)</sup>	MAX <sup>(1)</sup>	UNIT
<b>5-V LM2936HV ONLY</b>					
Output voltage	$5.5\text{ V} \leq V_{IN} \leq 48\text{ V}$ , $100\text{ }\mu\text{A} \leq I_{OUT} \leq 50\text{ mA}$ , <sup>(3)</sup> $-40^\circ\text{C} \leq T_J \leq 125^\circ\text{C}$	4.85	5	5.15	V
Line regulation	$6\text{ V} \leq V_{IN} \leq 60\text{ V}$ , $I_{OUT} = 1\text{ mA}$		15	35	mV
<b>ALL 5-V LM2936</b>					
Output voltage		4.9	5	5.1	V
	$5.5\text{ V} \leq V_{IN} \leq 26\text{ V}$ , $100\text{ }\mu\text{A} \leq I_{OUT} \leq 50\text{ mA}$ , <sup>(3)</sup> $-40^\circ\text{C} \leq T_J \leq 125^\circ\text{C}$	4.85	5	5.15	
Quiescent current	$I_{OUT} = 100\text{ }\mu\text{A}$ , $8\text{ V} \leq V_{IN} \leq 24\text{ V}$		9	15	$\mu\text{A}$
	$I_{OUT} = 10\text{ mA}$ , $8\text{ V} \leq V_{IN} \leq 24\text{ V}$		0.2	0.5	mA
	$I_{OUT} = 50\text{ mA}$ , $8\text{ V} \leq V_{IN} \leq 24\text{ V}$		1.5	2.5	mA
Line regulation	$9\text{ V} \leq V_{IN} \leq 16\text{ V}$		5	10	mV
	$6\text{ V} \leq V_{IN} \leq 40\text{ V}$ , $I_{OUT} = 1\text{ mA}$		10	30	
Load regulation	$100\text{ }\mu\text{A} \leq I_{OUT} \leq 5\text{ mA}$		10	30	mV
	$5\text{ mA} \leq I_{OUT} \leq 50\text{ mA}$		10	30	
Dropout voltage	$I_{OUT} = 100\text{ }\mu\text{A}$		0.05	0.1	V
	$I_{OUT} = 50\text{ mA}$		0.2	0.4	V
Short-circuit current	$V_{OUT} = 0\text{ V}$	65	120	250	mA
Output impedance	$I_{OUT} = 30\text{ mAdc}$ and $10\text{ mArms}$ , $f = 1000\text{ Hz}$		450		$\text{m}\Omega$
Output noise voltage	10 Hz–100 kHz		500		$\mu\text{V}$
Long-term stability			20		mV/1000 Hr
Ripple rejection	$V_{\text{ripple}} = 1\text{ V}_{\text{rms}}$ , $f_{\text{ripple}} = 120\text{ Hz}$	-40	-60		dB
Reverse polarity transient input voltage	$R_L = 500\text{ }\Omega$ , $T = 1\text{ ms}$	-50	-80		V
Output voltage with reverse polarity input	$V_{IN} = -15\text{ V}$ , $R_L = 500\text{ }\Omega$		0	-0.3	V
Maximum line transient	$R_L = 500\text{ }\Omega$ , $V_{OUT} \leq 5.5\text{ V}$ , $T = 40\text{ ms}$	60			V
Output bypass capacitance ( $C_{OUT}$ ) ESR	$C_{OUT} = 10\text{ }\mu\text{F}$ , $0.1\text{ mA} \leq I_{OUT} \leq 50\text{ mA}$	0.3		8	$\Omega$
<b>SHUTDOWN INPUT – 5-V LM2936BM ONLY</b>					
Output voltage, $V_{OUT}$	Output off, $V_{SD} = 2.4\text{ V}$ , $R_{LOAD} = 500\text{ }\Omega$		0	0.01	V
Shutdown high threshold voltage, $V_{IH}$	Output off, $R_{LOAD} = 500\text{ }\Omega$	2	1.1		V
Shutdown low threshold voltage, $V_{IL}$	Output on, $R_{LOAD} = 500\text{ }\Omega$		1.1	0.6	V
Shutdown high current, $I_{IH}$	Output off, $V_{SD} = 2.4\text{ V}$ , $R_{LOAD} = 500\text{ }\Omega$		12		$\mu\text{A}$
Quiescent current	Output off, $V_{SD} = 2.4\text{ V}$ , $R_{LOAD} = 500\text{ }\Omega$ , includes $I_{IH}$ current		30		$\mu\text{A}$

(1) Datasheet min/max specification limits are ensured by design, test, or statistical analysis.

(2) Typicals are at  $25^\circ\text{C}$  (unless otherwise specified) and represent the most likely parametric norm.

(3) To ensure constant junction temperature, pulse testing is used.

### 6.8 Typical Characteristics

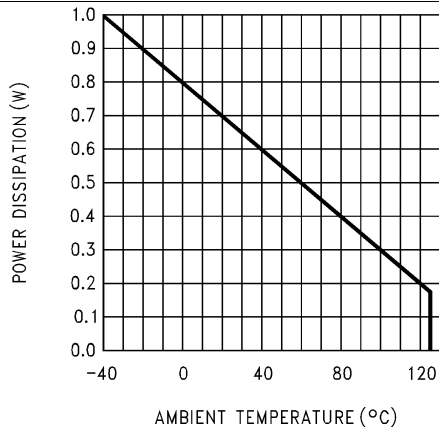

Figure 1. Maximum Power Dissipation (TO-92)

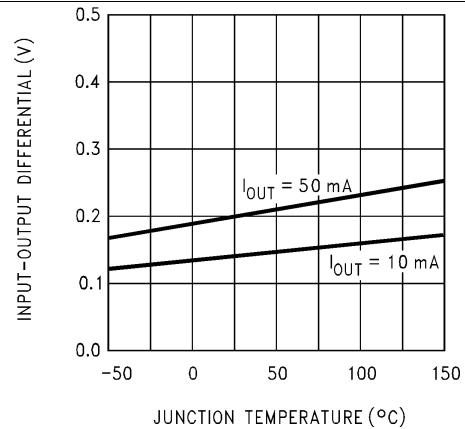

Figure 2. Dropout Voltage

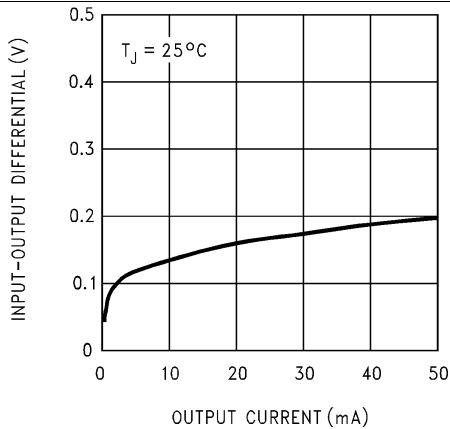

Figure 3. Dropout Voltage

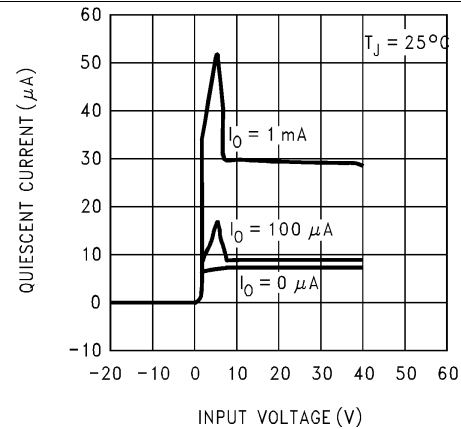

Figure 4. Quiescent Current

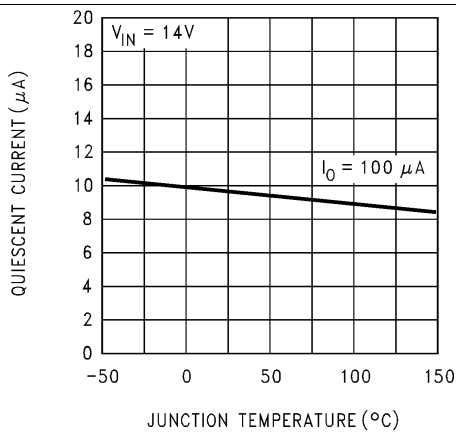

Figure 5. Quiescent Current

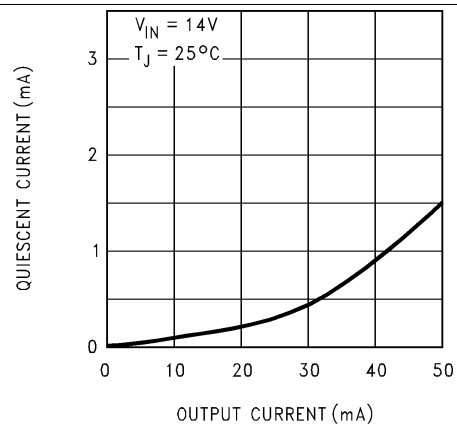

Figure 6. Quiescent Current



Typical Characteristics (continued)

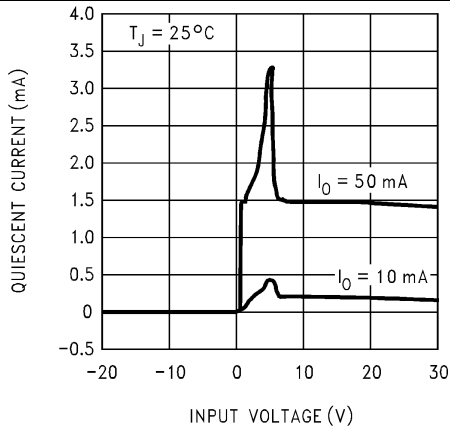

Figure 7. Quiescent Current

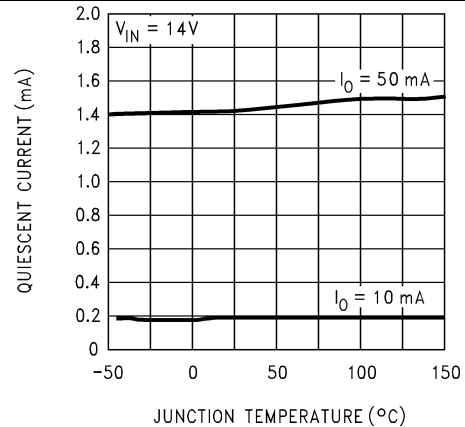

Figure 8. Quiescent Current

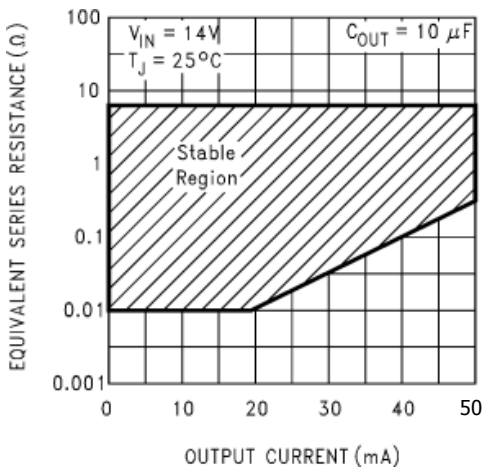

Figure 9. 5-V LM2936 C<sub>OUT</sub> ESR

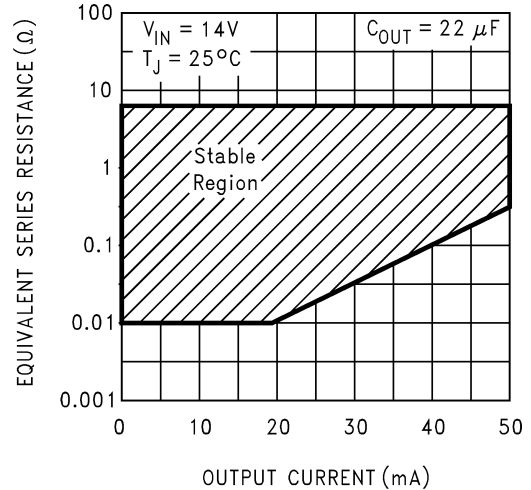

Figure 10. 3-V LM2936 C<sub>OUT</sub> ESR

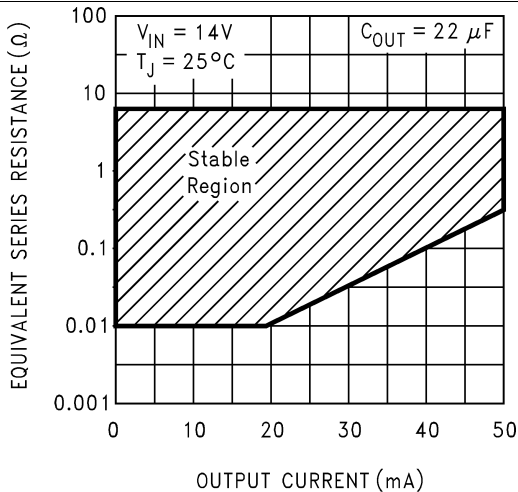

Figure 11. 3.3-V LM2936 C<sub>OUT</sub> ESR

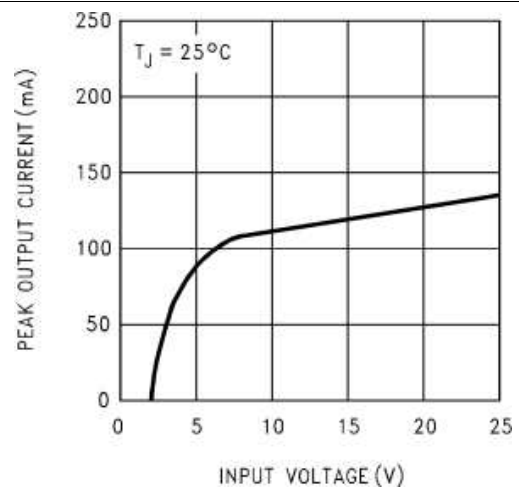

Figure 12. Peak Output Current

Typical Characteristics (continued)

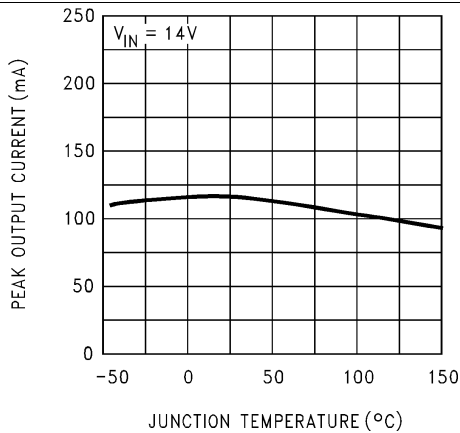

Figure 13. Peak Output Current

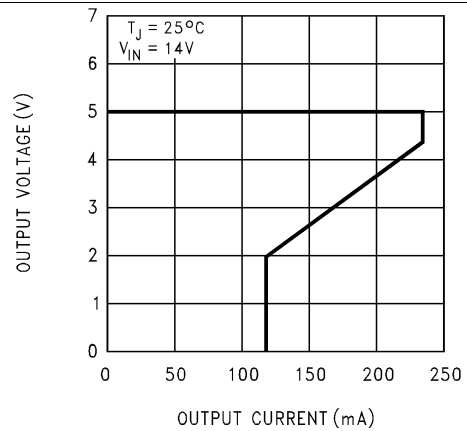

Figure 14. 5-V LM2936 Current Limit

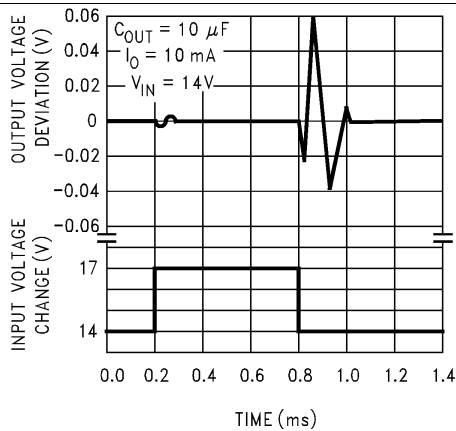

Figure 15. 5-V LM2936 Line Transient Response

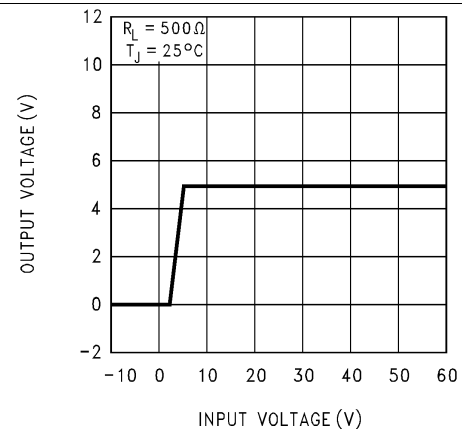

Figure 16. 5-V LM2936 Output at Voltage Extremes

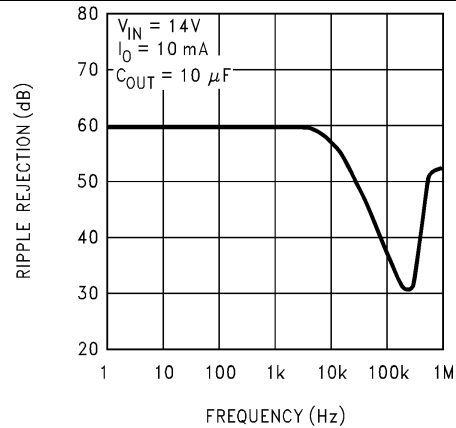

Figure 17. 5-V LM2936 Ripple Rejection

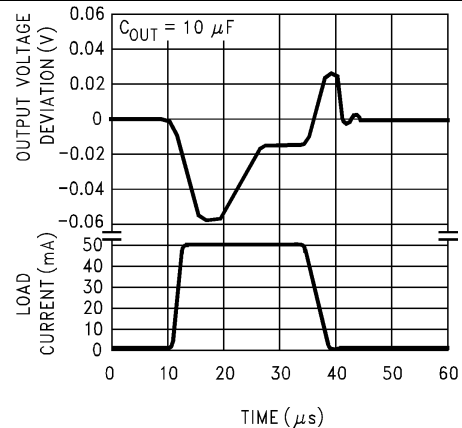
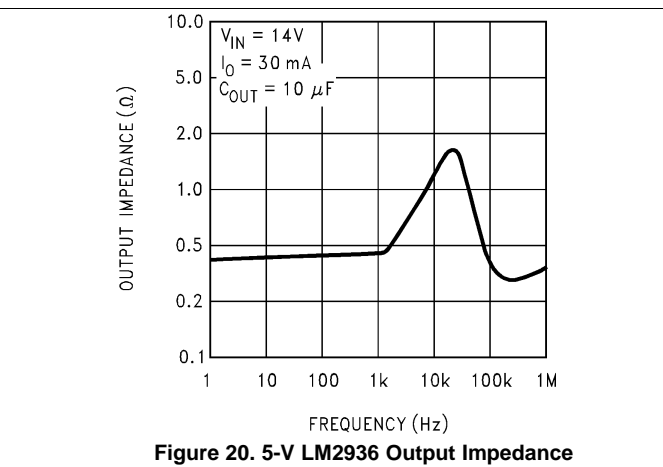
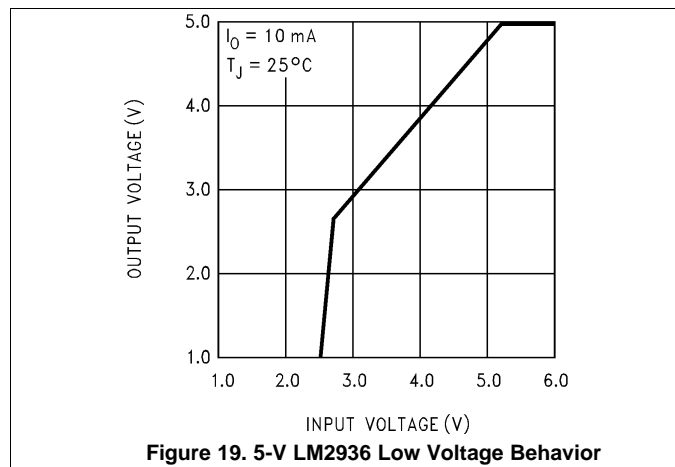

Figure 18. 5-V LM2936 Load Transient Response

**Typical Characteristics (continued)**



## 7 Detailed Description

### 7.1 Overview

The LM2936 ultra-low quiescent current regulator features low dropout voltage and low current in the standby mode. With less than 15  $\mu\text{A}$  quiescent current at a 100- $\mu\text{A}$  load, the LM2936 is ideally suited for automotive and other battery operated systems. The LM2936 retains all of the features that are common to low dropout regulators including a low dropout PNP pass device, short circuit protection, reverse battery input protection, and thermal shutdown. The LM2936 has a 40-V maximum operating voltage limit, a  $-40^{\circ}\text{C}$  to  $125^{\circ}\text{C}$  operating temperature range, and  $\pm 3\%$  output voltage tolerance over the entire output current, input voltage, and temperature range.

### 7.2 Functional Block Diagram



### 7.3 Feature Description

#### 7.3.1 High Input Operating Voltage

Unlike many other PNP low dropout regulators, the LM2936 remains fully operational with  $V_{\text{IN}} = 40\text{ V}$ , and the LM2936HV remains fully operational with  $V_{\text{IN}} = 60\text{ V}$ . Owing to power dissipation characteristics of the available packages, full output current cannot be ensured for all combinations of ambient temperature and input voltage.

While the LM2936HV maintains regulation to 60 V, it will not withstand a short circuit to ground on the output when  $V_{\text{IN}}$  is above 40 V because of safe operating area limitations in the internal PNP pass device. Above 60V the LM2936 will break down with catastrophic effects on the regulator and possibly the load as well. Do not use this device in a design where the input operating voltage may exceed 40 V, or where transients are likely to exceed 60 V.

#### 7.3.2 Thermal Shutdown (TSD)

The TSD circuitry of the LM2936 has been designed to protect the device against temporary thermal overload conditions. The TSD circuitry is not intended to replace proper heat-sinking. Continuously running the LM2936 device at TSD may degrade device reliability as the junction temperature will be exceeding the absolute maximum junction temperature rating. If the LM2936 goes into TSD mode, the output current will be shut off until the junction temperature falls approximately  $10^{\circ}\text{C}$ , then the output current will automatically be restored. The LM2936 will continuously cycle in and out of TSD until the condition is corrected. The LM2936 TSD junction temperature is typically  $160^{\circ}\text{C}$ .

## Feature Description (continued)

### 7.3.3 Short-Circuit Current Limit

The output current limiting circuitry of the LM2936 has been designed to limit the output current in cases where the load impedance is unusually low. This includes situations where the output may be shorted directly to ground. Continuous operation of the LM2936 at the current limit will typically result in the LM2936 transitioning into TSD mode.

### 7.3.4 Shutdown (SD) Pin

The LM2936BM has a pin for shutting down the regulator output. Applying a Logic Level High ( $> 2\text{ V}$ ) to the SD pin will cause the output to turn off. Leaving the SD pin open, connecting it to Ground, or applying a Logic Level Low ( $< 0.6\text{ V}$ ) will allow the regulator output to turn on.

## 7.4 Device Functional Modes

The LM2936 design does not include any undervoltage lockout (UVLO), or overvoltage shutdown (OVSD) functions. Generally, the output voltage will track the input voltage until the input voltage is greater than  $V_{\text{OUT}} + 1\text{ V}$ . When the input voltage is greater than  $V_{\text{OUT}} + 1\text{ V}$  the LM2936 will be in linear operation, and the output voltage will be regulated; however, the device will be sensitive to any small perturbation of the input voltage. Device dynamic performance is improved when the input voltage is at least  $2\text{ V}$  greater than the output voltage.

## 8 Application and Implementation

### NOTE

Information in the following applications sections is not part of the TI component specification, and TI does not warrant its accuracy or completeness. TI's customers are responsible for determining suitability of components for their purposes. Customers should validate and test their design implementation to confirm system functionality.

### 8.1 Application Information

The LM2936 ultra-low quiescent current regulator features low dropout voltage and low current in the standby mode. The LM2936 has a 40-V maximum operating voltage limit, a  $-40^{\circ}\text{C}$  to  $125^{\circ}\text{C}$  operating temperature range,  $-24\text{-V}$  input voltage protection and  $\pm 3\%$  output voltage tolerance over the entire output current, input voltage, and temperature range. This following section presents a simplified discussion of the design process. Also the WEBENCH<sup>®</sup> software may be used to generate complete designs. When generating a design, WEBENCH utilizes iterative design procedure and accesses comprehensive databases of components. Please go to [www.ti.com](http://www.ti.com) for more details.

### 8.2 Typical Application

Figure 21 shows the typical application circuit for the LM2936. For the LM2936 5-V option, the output capacitor,  $C_{\text{OUT}}$ , must have a capacitance value of at least  $10\ \mu\text{F}$  with an equivalent series resistance (ESR) of at least  $300\ \text{m}\Omega$ , but no more than  $8\ \Omega$ . For the LM2936 3.3-V and 3-V options, the output capacitor,  $C_{\text{OUT}}$ , must have a capacitance value of at least  $22\ \mu\text{F}$  with an ESR of at least  $300\ \text{m}\Omega$ , but no more than  $8\ \Omega$ . The minimum capacitance value and the ESR requirements apply across the entire expected operating ambient temperature range.

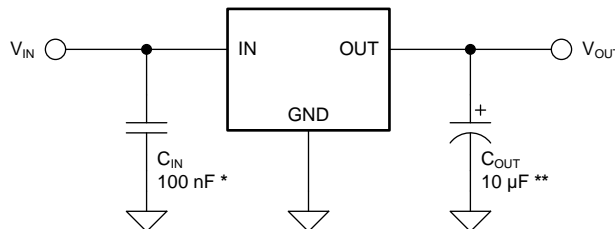

\*  $C_{\text{IN}}$  is required only if the regulator is located more than 3 inches from the power-supply-filter capacitors.

\*\* Required for stability.  $C_{\text{OUT}}$  must be at least  $10\ \mu\text{F}$  for the LM2936 5-V option, and at least  $22\ \mu\text{F}$  for the 3.3-V and 3-V options. Capacitance must be maintained over entire expected operating temperature range, and located as close as possible to the regulator. The ESR, of the  $C_{\text{OUT}}$  capacitor must at least  $300\ \text{m}\Omega$ , but no more than  $8\ \Omega$ .

Figure 21. LM2936 Typical Application

#### 8.2.1 Design Requirements

Table 1. Design Parameters

DESIGN PARAMETER	EXAMPLE VALUE
Output voltage	5 V
Input voltage	10 V to 26 V
Output current requirement	1 mA to 50 mA
Input capacitor	0.1 $\mu\text{F}$
Output capacitance	10 $\mu\text{F}$ minimum
Output capacitor ESR value	300 $\text{m}\Omega$ to 8 $\Omega$

## 8.2.2 Detailed Design Procedure

### 8.2.2.1 External Capacitors

The output capacitor is critical to maintaining regulator stability, and must meet the required conditions for both ESR and minimum amount of capacitance.

#### 8.2.2.1.1 Minimum Capacitance

The minimum output capacitance required to maintain stability is at least 10  $\mu\text{F}$  for the LM2936 5-V option, and at least 22  $\mu\text{F}$  for the 3.3-V and 3-V options. This value may be increased without limit. Larger values of output capacitance will give improved transient response.

#### 8.2.2.1.2 ESR Limits

The ESR of the output capacitor will cause loop instability if it is too high, or too low. ESR, of the  $C_{\text{OUT}}$  capacitor must at least 300  $\text{m}\Omega$ , but no more than 8  $\Omega$ .

### 8.2.2.2 Output Capacitor ESR

It is essential that the output capacitor meet the capacitance and ESR requirements, or oscillations can result. The ESR is used with the output capacitance in

Ceramic capacitors (MLCC) can be used for  $C_{\text{OUT}}$  only if a series resistor is added to simulate the ESR requirement. The ESR is not optional, it is mandatory. Typically, a 500- $\text{m}\Omega$  to 1- $\Omega$  series resistor is used for this purpose. When using ceramic capacitors, due diligence must be given to initial tolerances, capacitance derating due to applied DC voltage, and capacitance variations due to temperature. Dielectric types X5R and X7R are preferred.

## 8.2.3 Application Curve



**Figure 22. LM2936  $V_{\text{OUT}}$  vs.  $V_{\text{IN}}$**

## 9 Power Supply Recommendations

This device is designed to operate from an input supply voltage from at least  $V_{\text{OUT}} + 1\text{ V}$  up to a maximum of 40 V. The input supply should be well regulated and free of spurious noise. To ensure that the LM2936 output voltage is well regulated the input supply should be at least  $V_{\text{OUT}} + 2\text{ V}$ . A capacitor at the IN pin may not be specifically required if the bulk input supply filter capacitors are within three inches of the IN pin, but adding one will not be detrimental to operation.

While the LM2936 maintains regulation to  $V_{\text{IN}} = 60\text{ V}$ , it will not withstand a short circuit on the output with  $V_{\text{IN}}$  above 40 V because of safe operating area limitations in the internal PNP pass device. With  $V_{\text{IN}}$  above 60 V the LM2936 will break down with catastrophic effects on the regulator and possibly the load as well. Do not use this device in a design where the input operating voltage, including transients, is likely to exceed 60 V.

## 10 Layout

### 10.1 Layout Guidelines

The dynamic performance of the LM2936 is dependent on the layout of the PCB. PCB layout practices that are adequate for typical LDOs may degrade the PSRR, noise, or transient performance of the LM2936. Best performance is achieved by placing  $C_{IN}$  and  $C_{OUT}$  on the same side of the PCB as the LM2936, and as close as is practical to the package. The ground connections for  $C_{IN}$  and  $C_{OUT}$  should be back to the LM2936 ground pin using as wide, and as short, of a copper trace as is practical.

Connections using long trace lengths, narrow trace widths, and/or connections through vias should be avoided as these will add parasitic inductances and resistances that will give inferior performance, especially during transient conditions

### 10.2 Layout Examples



**Figure 23. LM2936BM SOIC (D) Layout**

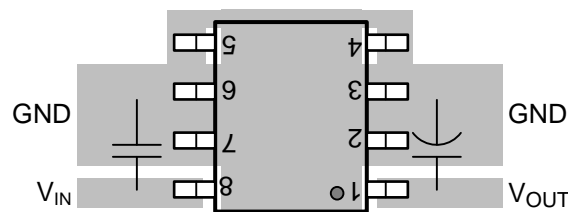

**Figure 24. LM2936M SOIC (D) Layout**



**Figure 25. LM2936 TO-252 (NDP) Layout**

### 10.3 Thermal Considerations

Due to the power dissipation characteristics of the available packages ( $R_{\theta JA}$ ), full output current cannot be ensured for all combinations of ambient temperature and input voltage.

Exceeding the maximum allowable power dissipation as defined by the final package  $R_{\theta JA}$  will cause excessive die junction temperature, and the regulator may go into thermal shutdown.

Power dissipation,  $P_D$ , is calculated from the following formula:

$$P_D = ((V_{IN} - V_{OUT}) \times I_{OUT}) + (V_{IN} \times I_{GND}) \quad (1)$$



## Thermal Considerations (continued)

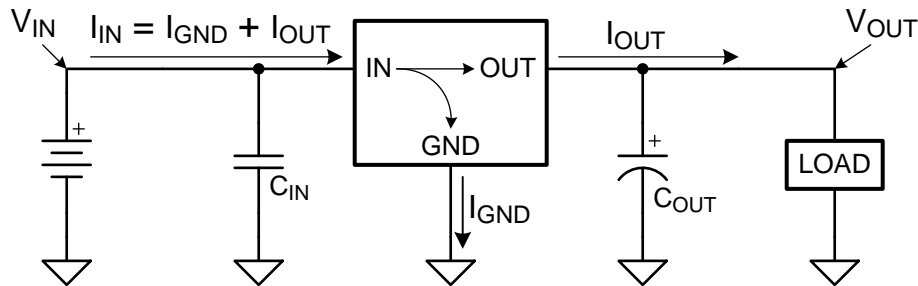

**Figure 26. Current Paths for Power Dissipation Calculation**

Knowing the power dissipation ( $P_D$ ), the thermal resistance of the package ( $R_{\theta JA}$ ), and the ambient temperature ( $T_A$ ), the junction temperature ( $T_J$ ) can be estimated using the following formula:

$$T_J = (P_D \times R_{\theta JA}) + T_A \quad (2)$$

Knowing the thermal resistance of the package ( $R_{\theta JA}$ ), the ambient temperature ( $T_A$ ), and the maximum allowed operating junction temperature ( $T_J$ ) of 125°C, the maximum power dissipation can be estimated using the following formula:

$$P_{D(MAX)} = (125^\circ\text{C} - T_A) / R_{\theta JA} \quad (3)$$

Alternately, solving for the required thermal resistance ( $R_{\theta JA}$ ):

$$R_{\theta JA} = (125^\circ\text{C} - T_A) / P_{D(MAX)} \quad (4)$$

The maximum allowed  $P_D$  information from [Equation 3](#) can be used to estimate the maximum allowed load current ( $I_{OUT}$ ), or the maximum allowed  $V_{IN}$ :

$$V_{IN(MAX)} = (P_{D(MAX)} / I_{OUT}) + V_{OUT} \quad (5)$$

$$I_{OUT(MAX)} = (P_{D(MAX)} / (V_{IN} - V_{OUT})) \quad (6)$$

As an example, an application requires :  $V_{IN} = 14\text{ V}$ ,  $V_{OUT} = 5\text{ V}$ ,  $I_{OUT} = 25\text{ mA}$ , and  $T_A = 85^\circ\text{C}$ . Find the maximum  $R_{\theta JA}$  to keep the junction temperature under 125°C.

$$R_{\theta JA} \leq (125^\circ\text{C} - T_A) / P_{D(MAX)} \quad (7)$$

$$R_{\theta JA} \leq (125^\circ\text{C} - 85^\circ\text{C}) / ((14\text{ V} - 5\text{ V}) \times 0.025\text{ A}) \quad (8)$$

$$R_{\theta JA} \leq 40^\circ\text{C} / 0.225\text{ W} \quad (9)$$

$$R_{\theta JA} \leq 177^\circ\text{C/W} \quad (10)$$

The EIA/JEDEC standard (JESD51-2) provides methodologies to estimate the junction temperature from external measurements ( $\Psi_{JB}$  references the temperature at the PCB, and  $\Psi_{JT}$  references the temperature at the top surface of the package) when operating under steady-state power dissipation conditions. These methodologies have been determined to be relatively independent of the copper thermal spreading area that may be attached to the package DAP when compared to the more typical  $R_{\theta JA}$ . Refer to Texas Instruments Application Report *Semiconductor and IC Package Thermal Metrics* ([SPRA953](#)), for specifics.

On the 8-pin SOIC (D) package, the four ground pins are thermally connected to the backside of the die. Adding approximately 0.04 square inches of 2 oz. copper pad area to these four pins will improve the JEDEC  $R_{\theta JA}$  rating from 111.4°C/W to approximately 100°C/W. If this extra copper area is placed directly beneath the SOIC package there should not be any impact on board density.

The LM2936 has an internally set thermal shutdown point of typically 160°C. Thermal shutdown is outside the ensured operating temperature range and is intended as a safety feature only. Continuous operation near the thermal shutdown temperature should be avoided as it may have a negative affect on the life of the device.

## 11 Device and Documentation Support

### 11.1 Documentation Support

#### 11.1.1 Related Documentation

For related documentation see the following:

Texas Instruments Application Report *Semiconductor and IC Package Thermal Metrics* ([SPRA953](#))

### 11.2 Trademarks

WEBENCH is a registered trademark of Texas Instruments.  
All other trademarks are the property of their respective owners.

### 11.3 Electrostatic Discharge Caution



These devices have limited built-in ESD protection. The leads should be shorted together or the device placed in conductive foam during storage or handling to prevent electrostatic damage to the MOS gates.

### 11.4 Glossary

[SLYZ022](#) — *TI Glossary*.

This glossary lists and explains terms, acronyms, and definitions.

## 12 Mechanical, Packaging, and Orderable Information

The following pages include mechanical, packaging, and orderable information. This information is the most current data available for the designated devices. This data is subject to change without notice and revision of this document. For browser-based versions of this data sheet, refer to the left-hand navigation.

**PACKAGING INFORMATION**

Orderable Device	Status (1)	Package Type	Package Drawing	Pins	Package Qty	Eco Plan (2)	Lead/Ball Finish (6)	MSL Peak Temp (3)	Op Temp (°C)	Device Marking (4/5)	Samples
LM2936BM-3.3/NOPB	ACTIVE	SOIC	D	8	95	Green (RoHS & no Sb/Br)	CU SN	Level-1-260C-UNLIM	-40 to 125	LM2936B3.3	<a href="#">Samples</a>
LM2936BM-5.0/NOPB	ACTIVE	SOIC	D	8	95	Green (RoHS & no Sb/Br)	CU SN	Level-1-260C-UNLIM	-40 to 125	LM2936B5.0	<a href="#">Samples</a>
LM2936BMX-3.3/NOPB	ACTIVE	SOIC	D	8	2500	Green (RoHS & no Sb/Br)	CU SN	Level-1-260C-UNLIM	-40 to 125	LM2936B3.3	<a href="#">Samples</a>
LM2936BMX-5.0/NOPB	ACTIVE	SOIC	D	8	2500	Green (RoHS & no Sb/Br)	CU SN	Level-1-260C-UNLIM	-40 to 125	LM2936B5.0	<a href="#">Samples</a>
LM2936DT-3.0/NOPB	ACTIVE	TO-252	NDP	3	75	Green (RoHS & no Sb/Br)	CU SN	Level-2-260C-1 YEAR	-40 to 125	LM2936DT-3.0	<a href="#">Samples</a>
LM2936DT-3.3/NOPB	ACTIVE	TO-252	NDP	3	75	Green (RoHS & no Sb/Br)	CU SN	Level-2-260C-1 YEAR	-40 to 125	LM2936DT-3.3	<a href="#">Samples</a>
LM2936DT-5.0	NRND	TO-252	NDP	3	75	TBD	Call TI	Call TI	-40 to 125	LM2936DT-5.0	
LM2936DT-5.0/NOPB	ACTIVE	TO-252	NDP	3	75	Green (RoHS & no Sb/Br)	CU SN	Level-2-260C-1 YEAR	-40 to 125	LM2936DT-5.0	<a href="#">Samples</a>
LM2936DTX-3.3/NOPB	ACTIVE	TO-252	NDP	3	2500	Green (RoHS & no Sb/Br)	CU SN	Level-2-260C-1 YEAR	-40 to 125	LM2936DTX-3.3	<a href="#">Samples</a>
LM2936DTX-5.0	NRND	TO-252	NDP	3	2500	TBD	Call TI	Call TI	-40 to 125	LM2936DTX-5.0	
LM2936DTX-5.0/NOPB	ACTIVE	TO-252	NDP	3	2500	Green (RoHS & no Sb/Br)	CU SN	Level-2-260C-1 YEAR	-40 to 125	LM2936DTX-5.0	<a href="#">Samples</a>
LM2936HVBMA-3.3	NRND	SOIC	D	8	95	TBD	Call TI	Call TI	-40 to 125	2936HBM3.3	
LM2936HVBMA-3.3/NOPB	ACTIVE	SOIC	D	8	95	Green (RoHS & no Sb/Br)	CU SN	Level-1-260C-UNLIM	-40 to 125	2936HBM3.3	<a href="#">Samples</a>
LM2936HVBMA-5.0	NRND	SOIC	D	8	95	TBD	Call TI	Call TI	-40 to 125	2936HBM5.0	
LM2936HVBMA-5.0/NOPB	ACTIVE	SOIC	D	8	95	Green (RoHS & no Sb/Br)	CU SN	Level-1-260C-UNLIM	-40 to 125	2936HBM5.0	<a href="#">Samples</a>
LM2936HVBMAX3.3	NRND	SOIC	D	8	2500	TBD	Call TI	Call TI		2936HBM3.3	
LM2936HVBMAX3.3/NOPB	ACTIVE	SOIC	D	8	2500	Green (RoHS & no Sb/Br)	CU SN	Level-1-260C-UNLIM		2936HBM3.3	<a href="#">Samples</a>

Orderable Device	Status (1)	Package Type	Package Drawing	Pins	Package Qty	Eco Plan (2)	Lead/Ball Finish (6)	MSL Peak Temp (3)	Op Temp (°C)	Device Marking (4/5)	Samples
LM2936HVBMAX5.0/NOPB	ACTIVE	SOIC	D	8	2500	Green (RoHS & no Sb/Br)	CU SN	Level-1-260C-UNLIM		2936H BM5.0	<a href="#">Samples</a>
LM2936HVMA-5.0	NRND	SOIC	D	8	95	TBD	Call TI	Call TI	-40 to 125	2936H M-5.0	
LM2936HVMA-5.0/NOPB	ACTIVE	SOIC	D	8	95	Green (RoHS & no Sb/Br)	CU SN	Level-1-260C-UNLIM	-40 to 125	2936H M-5.0	<a href="#">Samples</a>
LM2936HVMAX-5.0	NRND	SOIC	D	8	2500	TBD	Call TI	Call TI	-40 to 125	2936H M-5.0	
LM2936HVMAX-5.0/NOPB	ACTIVE	SOIC	D	8	2500	Green (RoHS & no Sb/Br)	CU SN	Level-1-260C-UNLIM	-40 to 125	2936H M-5.0	<a href="#">Samples</a>
LM2936M-3.0/NOPB	ACTIVE	SOIC	D	8	95	Green (RoHS & no Sb/Br)	CU SN	Level-1-260C-UNLIM	-40 to 125	LM293 6M-3	<a href="#">Samples</a>
LM2936M-3.3	NRND	SOIC	D	8	95	TBD	Call TI	Call TI	-40 to 125	LM293 6-3.3	
LM2936M-3.3/NOPB	ACTIVE	SOIC	D	8	95	Green (RoHS & no Sb/Br)	CU SN	Level-1-260C-UNLIM	-40 to 125	LM293 6-3.3	<a href="#">Samples</a>
LM2936M-5.0	NRND	SOIC	D	8	95	TBD	Call TI	Call TI	-40 to 125	LM293 6M-5	
LM2936M-5.0/NOPB	ACTIVE	SOIC	D	8	95	Green (RoHS & no Sb/Br)	CU SN	Level-1-260C-UNLIM	-40 to 125	LM293 6M-5	<a href="#">Samples</a>
LM2936MM-3.0/NOPB	ACTIVE	VSSOP	DGK	8	1000	Green (RoHS & no Sb/Br)	CU SN	Level-1-260C-UNLIM	-40 to 125	KBC	<a href="#">Samples</a>
LM2936MM-3.3	NRND	VSSOP	DGK	8	1000	TBD	Call TI	Call TI	-40 to 125	KBB	
LM2936MM-3.3/NOPB	ACTIVE	VSSOP	DGK	8	1000	Green (RoHS & no Sb/Br)	CU SN	Level-1-260C-UNLIM	-40 to 125	KBB	<a href="#">Samples</a>
LM2936MM-5.0/NOPB	ACTIVE	VSSOP	DGK	8	1000	Green (RoHS & no Sb/Br)	CU SN	Level-1-260C-UNLIM	-40 to 125	KBA	<a href="#">Samples</a>
LM2936MMX-3.3/NOPB	ACTIVE	VSSOP	DGK	8	3500	Green (RoHS & no Sb/Br)	CU SN	Level-1-260C-UNLIM	-40 to 125	KBB	<a href="#">Samples</a>
LM2936MMX-5.0	NRND	VSSOP	DGK	8	3500	TBD	Call TI	Call TI	-40 to 125	KBA	
LM2936MMX-5.0/NOPB	ACTIVE	VSSOP	DGK	8	3500	Green (RoHS & no Sb/Br)	CU SN	Level-1-260C-UNLIM	-40 to 125	KBA	<a href="#">Samples</a>
LM2936MP-3.0/NOPB	ACTIVE	SOT-223	DCY	4	1000	Green (RoHS & no Sb/Br)	CU SN	Level-1-260C-UNLIM		KACA	<a href="#">Samples</a>
LM2936MP-3.3	NRND	SOT-223	DCY	4	1000	TBD	Call TI	Call TI	-40 to 125	KABA	

Orderable Device	Status (1)	Package Type	Package Drawing	Pins	Package Qty	Eco Plan (2)	Lead/Ball Finish (6)	MSL Peak Temp (3)	Op Temp (°C)	Device Marking (4/5)	Samples
LM2936MP-3.3/NOPB	ACTIVE	SOT-223	DCY	4	1000	Green (RoHS & no Sb/Br)	CU SN	Level-1-260C-UNLIM	-40 to 125	KABA	<a href="#">Samples</a>
LM2936MP-5.0	NRND	SOT-223	DCY	4	1000	TBD	Call TI	Call TI	-40 to 125	KAAA	
LM2936MP-5.0/NOPB	ACTIVE	SOT-223	DCY	4	1000	Green (RoHS & no Sb/Br)	CU SN	Level-1-260C-UNLIM	-40 to 125	KAAA	<a href="#">Samples</a>
LM2936MPX-3.0/NOPB	ACTIVE	SOT-223	DCY	4	2000	Green (RoHS & no Sb/Br)	CU SN	Level-1-260C-UNLIM	-40 to 125	KACA	<a href="#">Samples</a>
LM2936MPX-3.3/NOPB	ACTIVE	SOT-223	DCY	4	2000	Green (RoHS & no Sb/Br)	CU SN	Level-1-260C-UNLIM	-40 to 125	KABA	<a href="#">Samples</a>
LM2936MPX-5.0/NOPB	ACTIVE	SOT-223	DCY	4	2000	Green (RoHS & no Sb/Br)	CU SN	Level-1-260C-UNLIM	-40 to 125	KAAA	<a href="#">Samples</a>
LM2936MX-3.3/NOPB	ACTIVE	SOIC	D	8	2500	Green (RoHS & no Sb/Br)	CU SN	Level-1-260C-UNLIM	-40 to 125	LM293 6-3.3	<a href="#">Samples</a>
LM2936MX-5.0	NRND	SOIC	D	8	2500	TBD	Call TI	Call TI	-40 to 125	LM293 6M-5	
LM2936MX-5.0/NOPB	ACTIVE	SOIC	D	8	2500	Green (RoHS & no Sb/Br)	CU SN	Level-1-260C-UNLIM	-40 to 125	LM293 6M-5	<a href="#">Samples</a>
LM2936Z-3.0/NOPB	LIFEBUY	TO-92	LP	3	1800	Green (RoHS & no Sb/Br)	CU SN	N / A for Pkg Type	-40 to 125	LM2936 Z-3	
LM2936Z-3.3/NOPB	ACTIVE	TO-92	LP	3	1800	Green (RoHS & no Sb/Br)	CU SN	N / A for Pkg Type	-40 to 125	LM2936 Z-3.3	<a href="#">Samples</a>
LM2936Z-5.0/LFT1	ACTIVE	TO-92	LP	3	2000	Green (RoHS & no Sb/Br)	CU SN	N / A for Pkg Type		LM293 6Z-5	<a href="#">Samples</a>
LM2936Z-5.0/LFT3	ACTIVE	TO-92	LP	3	2000	Green (RoHS & no Sb/Br)	CU SN	N / A for Pkg Type		LM293 6Z-5	<a href="#">Samples</a>
LM2936Z-5.0/LFT4	ACTIVE	TO-92	LP	3	2000	Green (RoHS & no Sb/Br)	CU SN	N / A for Pkg Type		LM293 6Z-5	<a href="#">Samples</a>
LM2936Z-5.0/NOPB	ACTIVE	TO-92	LP	3	1800	Green (RoHS & no Sb/Br)	CU SN	N / A for Pkg Type	-40 to 125	LM293 6Z-5	<a href="#">Samples</a>

(1) The marketing status values are defined as follows:

**ACTIVE:** Product device recommended for new designs.

**LIFEBUY:** TI has announced that the device will be discontinued, and a lifetime-buy period is in effect.

**NRND:** Not recommended for new designs. Device is in production to support existing customers, but TI does not recommend using this part in a new design.

**PREVIEW:** Device has been announced but is not in production. Samples may or may not be available.

**OBSELETE:** TI has discontinued the production of the device.

---

<sup>(2)</sup> Eco Plan - The planned eco-friendly classification: Pb-Free (RoHS), Pb-Free (RoHS Exempt), or Green (RoHS & no Sb/Br) - please check <http://www.ti.com/productcontent> for the latest availability information and additional product content details.

**TBD:** The Pb-Free/Green conversion plan has not been defined.

**Pb-Free (RoHS):** TI's terms "Lead-Free" or "Pb-Free" mean semiconductor products that are compatible with the current RoHS requirements for all 6 substances, including the requirement that lead not exceed 0.1% by weight in homogeneous materials. Where designed to be soldered at high temperatures, TI Pb-Free products are suitable for use in specified lead-free processes.

**Pb-Free (RoHS Exempt):** This component has a RoHS exemption for either 1) lead-based flip-chip solder bumps used between the die and package, or 2) lead-based die adhesive used between the die and leadframe. The component is otherwise considered Pb-Free (RoHS compatible) as defined above.

**Green (RoHS & no Sb/Br):** TI defines "Green" to mean Pb-Free (RoHS compatible), and free of Bromine (Br) and Antimony (Sb) based flame retardants (Br or Sb do not exceed 0.1% by weight in homogeneous material)

<sup>(3)</sup> MSL, Peak Temp. - The Moisture Sensitivity Level rating according to the JEDEC industry standard classifications, and peak solder temperature.

<sup>(4)</sup> There may be additional marking, which relates to the logo, the lot trace code information, or the environmental category on the device.

<sup>(5)</sup> Multiple Device Markings will be inside parentheses. Only one Device Marking contained in parentheses and separated by a "~" will appear on a device. If a line is indented then it is a continuation of the previous line and the two combined represent the entire Device Marking for that device.

<sup>(6)</sup> Lead/Ball Finish - Orderable Devices may have multiple material finish options. Finish options are separated by a vertical ruled line. Lead/Ball Finish values may wrap to two lines if the finish value exceeds the maximum column width.

**Important Information and Disclaimer:** The information provided on this page represents TI's knowledge and belief as of the date that it is provided. TI bases its knowledge and belief on information provided by third parties, and makes no representation or warranty as to the accuracy of such information. Efforts are underway to better integrate information from third parties. TI has taken and continues to take reasonable steps to provide representative and accurate information but may not have conducted destructive testing or chemical analysis on incoming materials and chemicals. TI and TI suppliers consider certain information to be proprietary, and thus CAS numbers and other limited information may not be available for release.

In no event shall TI's liability arising out of such information exceed the total purchase price of the TI part(s) at issue in this document sold by TI to Customer on an annual basis.

**TAPE AND REEL INFORMATION**

**QUADRANT ASSIGNMENTS FOR PIN 1 ORIENTATION IN TAPE**

\*All dimensions are nominal

Device	Package Type	Package Drawing	Pins	SPQ	Reel Diameter (mm)	Reel Width W1 (mm)	A0 (mm)	B0 (mm)	K0 (mm)	P1 (mm)	W (mm)	Pin1 Quadrant
LM2936BMX-3.3/NOPB	SOIC	D	8	2500	330.0	12.4	6.5	5.4	2.0	8.0	12.0	Q1
LM2936BMX-5.0/NOPB	SOIC	D	8	2500	330.0	12.4	6.5	5.4	2.0	8.0	12.0	Q1
LM2936DTX-3.3/NOPB	TO-252	NDP	3	2500	330.0	16.4	6.9	10.5	2.7	8.0	16.0	Q2
LM2936DTX-5.0	TO-252	NDP	3	2500	330.0	16.4	6.9	10.5	2.7	8.0	16.0	Q2
LM2936DTX-5.0/NOPB	TO-252	NDP	3	2500	330.0	16.4	6.9	10.5	2.7	8.0	16.0	Q2
LM2936HVBMAX3.3	SOIC	D	8	2500	330.0	12.4	6.5	5.4	2.0	8.0	12.0	Q1
LM2936HVBMAX3.3/NOPB	SOIC	D	8	2500	330.0	12.4	6.5	5.4	2.0	8.0	12.0	Q1
LM2936HVBMAX5.0/NOPB	SOIC	D	8	2500	330.0	12.4	6.5	5.4	2.0	8.0	12.0	Q1
LM2936HVMAX-5.0	SOIC	D	8	2500	330.0	12.4	6.5	5.4	2.0	8.0	12.0	Q1
LM2936HVMAX-5.0/NOPB	SOIC	D	8	2500	330.0	12.4	6.5	5.4	2.0	8.0	12.0	Q1
LM2936MM-3.0/NOPB	VSSOP	DGK	8	1000	178.0	12.4	5.3	3.4	1.4	8.0	12.0	Q1
LM2936MM-3.3	VSSOP	DGK	8	1000	178.0	12.4	5.3	3.4	1.4	8.0	12.0	Q1
LM2936MM-3.3/NOPB	VSSOP	DGK	8	1000	178.0	12.4	5.3	3.4	1.4	8.0	12.0	Q1
LM2936MM-5.0/NOPB	VSSOP	DGK	8	1000	178.0	12.4	5.3	3.4	1.4	8.0	12.0	Q1
LM2936MMX-3.3/NOPB	VSSOP	DGK	8	3500	330.0	12.4	5.3	3.4	1.4	8.0	12.0	Q1
LM2936MMX-5.0	VSSOP	DGK	8	3500	330.0	12.4	5.3	3.4	1.4	8.0	12.0	Q1

Device	Package Type	Package Drawing	Pins	SPQ	Reel Diameter (mm)	Reel Width W1 (mm)	A0 (mm)	B0 (mm)	K0 (mm)	P1 (mm)	W (mm)	Pin1 Quadrant
LM2936MMX-5.0/NOPB	VSSOP	DGK	8	3500	330.0	12.4	5.3	3.4	1.4	8.0	12.0	Q1
LM2936MP-3.0/NOPB	SOT-223	DCY	4	1000	330.0	16.4	7.0	7.5	2.2	12.0	16.0	Q3
LM2936MP-3.3	SOT-223	DCY	4	1000	330.0	16.4	7.0	7.5	2.2	12.0	16.0	Q3
LM2936MP-3.3/NOPB	SOT-223	DCY	4	1000	330.0	16.4	7.0	7.5	2.2	12.0	16.0	Q3
LM2936MP-5.0	SOT-223	DCY	4	1000	330.0	16.4	7.0	7.5	2.2	12.0	16.0	Q3
LM2936MP-5.0/NOPB	SOT-223	DCY	4	1000	330.0	16.4	7.0	7.5	2.2	12.0	16.0	Q3
LM2936MPX-3.0/NOPB	SOT-223	DCY	4	2000	330.0	16.4	7.0	7.5	2.2	12.0	16.0	Q3
LM2936MPX-3.3/NOPB	SOT-223	DCY	4	2000	330.0	16.4	7.0	7.5	2.2	12.0	16.0	Q3
LM2936MPX-5.0/NOPB	SOT-223	DCY	4	2000	330.0	16.4	7.0	7.5	2.2	12.0	16.0	Q3
LM2936MX-3.3/NOPB	SOIC	D	8	2500	330.0	12.4	6.5	5.4	2.0	8.0	12.0	Q1
LM2936MX-5.0	SOIC	D	8	2500	330.0	12.4	6.5	5.4	2.0	8.0	12.0	Q1
LM2936MX-5.0/NOPB	SOIC	D	8	2500	330.0	12.4	6.5	5.4	2.0	8.0	12.0	Q1

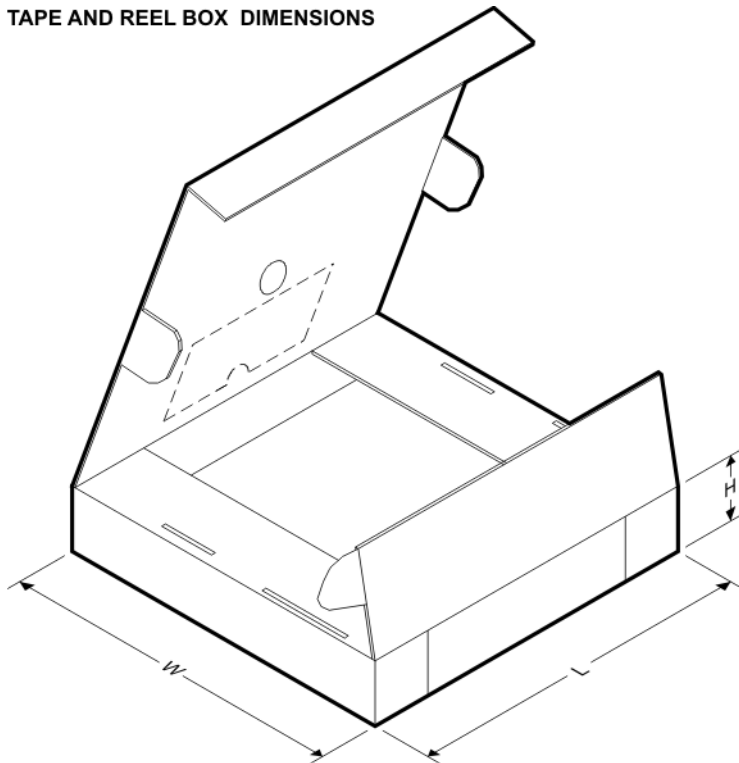
**TAPE AND REEL BOX DIMENSIONS**

\*All dimensions are nominal

Device	Package Type	Package Drawing	Pins	SPQ	Length (mm)	Width (mm)	Height (mm)
LM2936BMX-3.3/NOPB	SOIC	D	8	2500	367.0	367.0	35.0
LM2936BMX-5.0/NOPB	SOIC	D	8	2500	367.0	367.0	35.0
LM2936DTX-3.3/NOPB	TO-252	NDP	3	2500	367.0	367.0	38.0
LM2936DTX-5.0	TO-252	NDP	3	2500	367.0	367.0	35.0
LM2936DTX-5.0/NOPB	TO-252	NDP	3	2500	367.0	367.0	38.0



Device	Package Type	Package Drawing	Pins	SPQ	Length (mm)	Width (mm)	Height (mm)
LM2936HVBMAX3.3	SOIC	D	8	2500	367.0	367.0	35.0
LM2936HVBMAX3.3/NOPB	SOIC	D	8	2500	367.0	367.0	35.0
LM2936HVBMAX5.0/NOPB	SOIC	D	8	2500	367.0	367.0	35.0
LM2936HVMAX-5.0	SOIC	D	8	2500	367.0	367.0	35.0
LM2936HVMAX-5.0/NOPB	SOIC	D	8	2500	367.0	367.0	35.0
LM2936MM-3.0/NOPB	VSSOP	DGK	8	1000	210.0	185.0	35.0
LM2936MM-3.3	VSSOP	DGK	8	1000	210.0	185.0	35.0
LM2936MM-3.3/NOPB	VSSOP	DGK	8	1000	210.0	185.0	35.0
LM2936MM-5.0/NOPB	VSSOP	DGK	8	1000	210.0	185.0	35.0
LM2936MMX-3.3/NOPB	VSSOP	DGK	8	3500	367.0	367.0	35.0
LM2936MMX-5.0	VSSOP	DGK	8	3500	367.0	367.0	35.0
LM2936MMX-5.0/NOPB	VSSOP	DGK	8	3500	367.0	367.0	35.0
LM2936MP-3.0/NOPB	SOT-223	DCY	4	1000	367.0	367.0	35.0
LM2936MP-3.3	SOT-223	DCY	4	1000	367.0	367.0	35.0
LM2936MP-3.3/NOPB	SOT-223	DCY	4	1000	367.0	367.0	35.0
LM2936MP-5.0	SOT-223	DCY	4	1000	367.0	367.0	35.0
LM2936MP-5.0/NOPB	SOT-223	DCY	4	1000	367.0	367.0	35.0
LM2936MPX-3.0/NOPB	SOT-223	DCY	4	2000	367.0	367.0	35.0
LM2936MPX-3.3/NOPB	SOT-223	DCY	4	2000	367.0	367.0	35.0
LM2936MPX-5.0/NOPB	SOT-223	DCY	4	2000	367.0	367.0	35.0
LM2936MX-3.3/NOPB	SOIC	D	8	2500	367.0	367.0	35.0
LM2936MX-5.0	SOIC	D	8	2500	367.0	367.0	35.0
LM2936MX-5.0/NOPB	SOIC	D	8	2500	367.0	367.0	35.0

NDP0003B

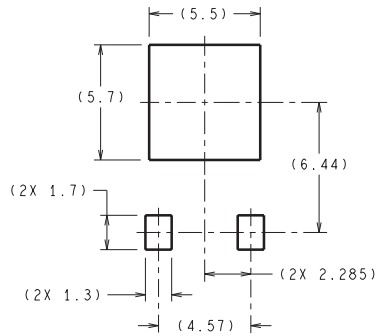

DIMENSIONS ARE IN MILLIMETERS  
 DIMENSIONS IN ( ) FOR REFERENCE ONLY

LAND PATTERN RECOMMENDATION

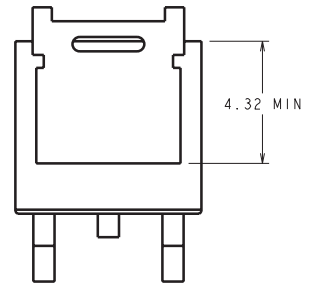
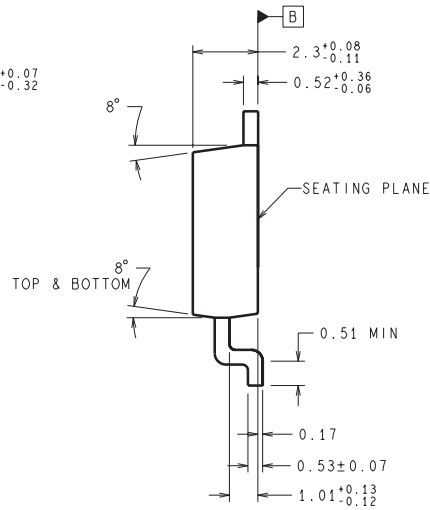
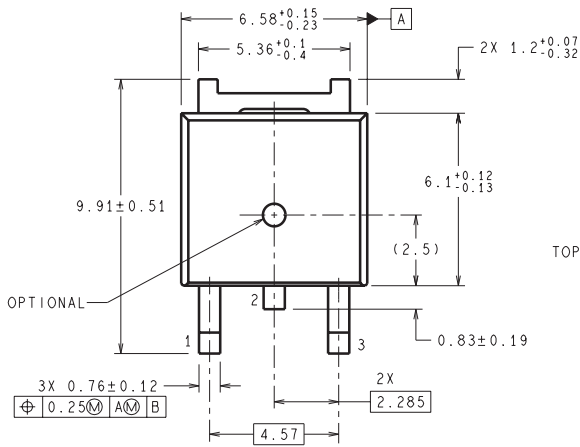

TD03B (Rev F)

DGK (S-PDSO-G8)

PLASTIC SMALL-OUTLINE PACKAGE

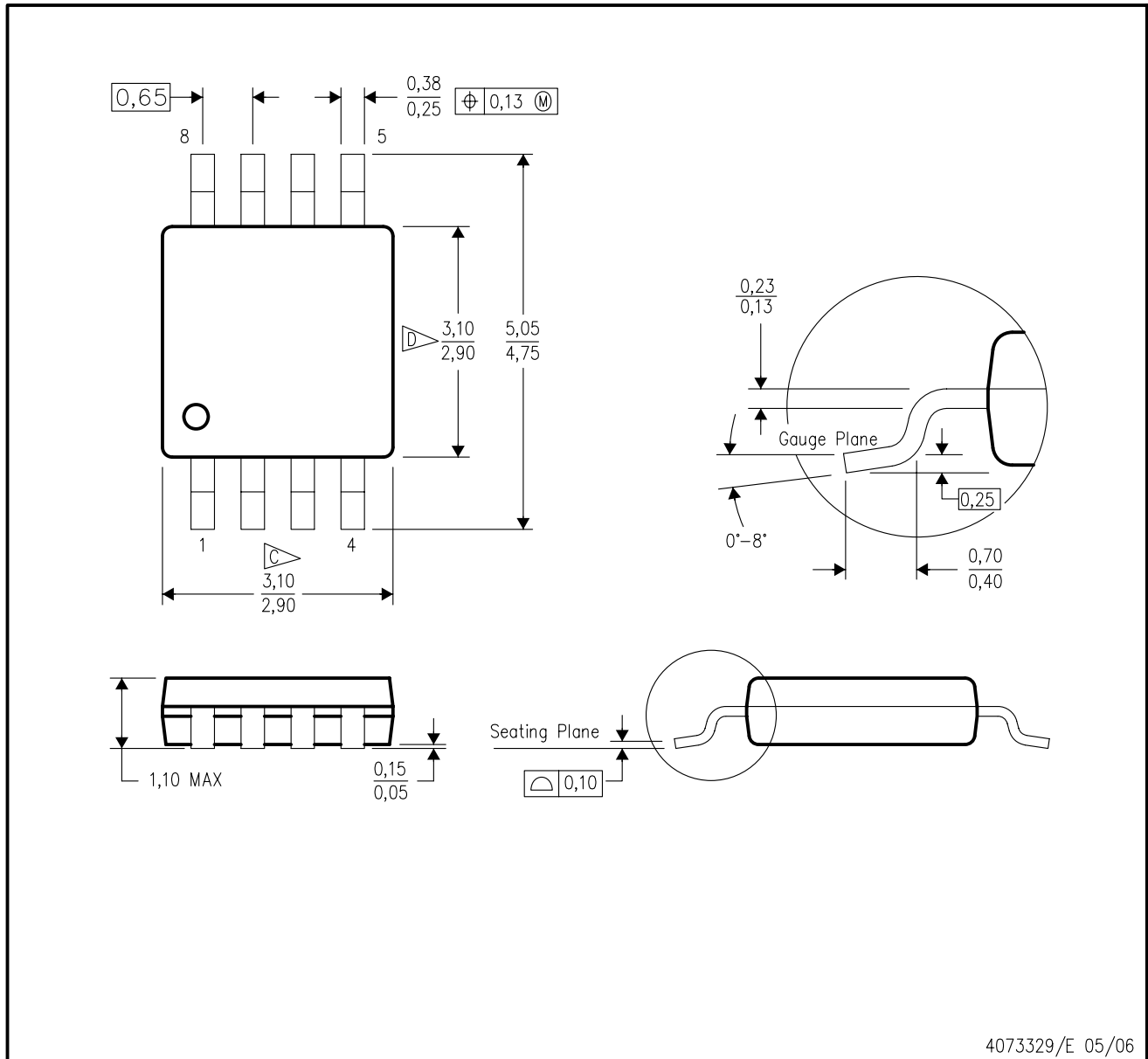

4073329/E 05/06

- NOTES:
- A. All linear dimensions are in millimeters.
  - B. This drawing is subject to change without notice.
  - C. Body length does not include mold flash, protrusions, or gate burrs. Mold flash, protrusions, or gate burrs shall not exceed 0.15 per end.
  - D. Body width does not include interlead flash. Interlead flash shall not exceed 0.50 per side.
  - E. Falls within JEDEC MO-187 variation AA, except interlead flash.



- NOTES:
- A. All linear dimensions are in millimeters.
  - B. This drawing is subject to change without notice.
  - C. Publication IPC-7351 is recommended for alternate designs.
  - D. Laser cutting apertures with trapezoidal walls and also rounding corners will offer better paste release. Customers should contact their board assembly site for stencil design recommendations. Refer to IPC-7525 for other stencil recommendations.
  - E. Customers should contact their board fabrication site for solder mask tolerances between and around signal pads.

DCY (R-PDSO-G4)

PLASTIC SMALL-OUTLINE



- NOTES: A. All linear dimensions are in millimeters (inches).  
 B. This drawing is subject to change without notice.  
 C. Body dimensions do not include mold flash or protrusion.  
 D. Falls within JEDEC TO-261 Variation AA.

DCY (R-PDSO-G4)

PLASTIC SMALL OUTLINE

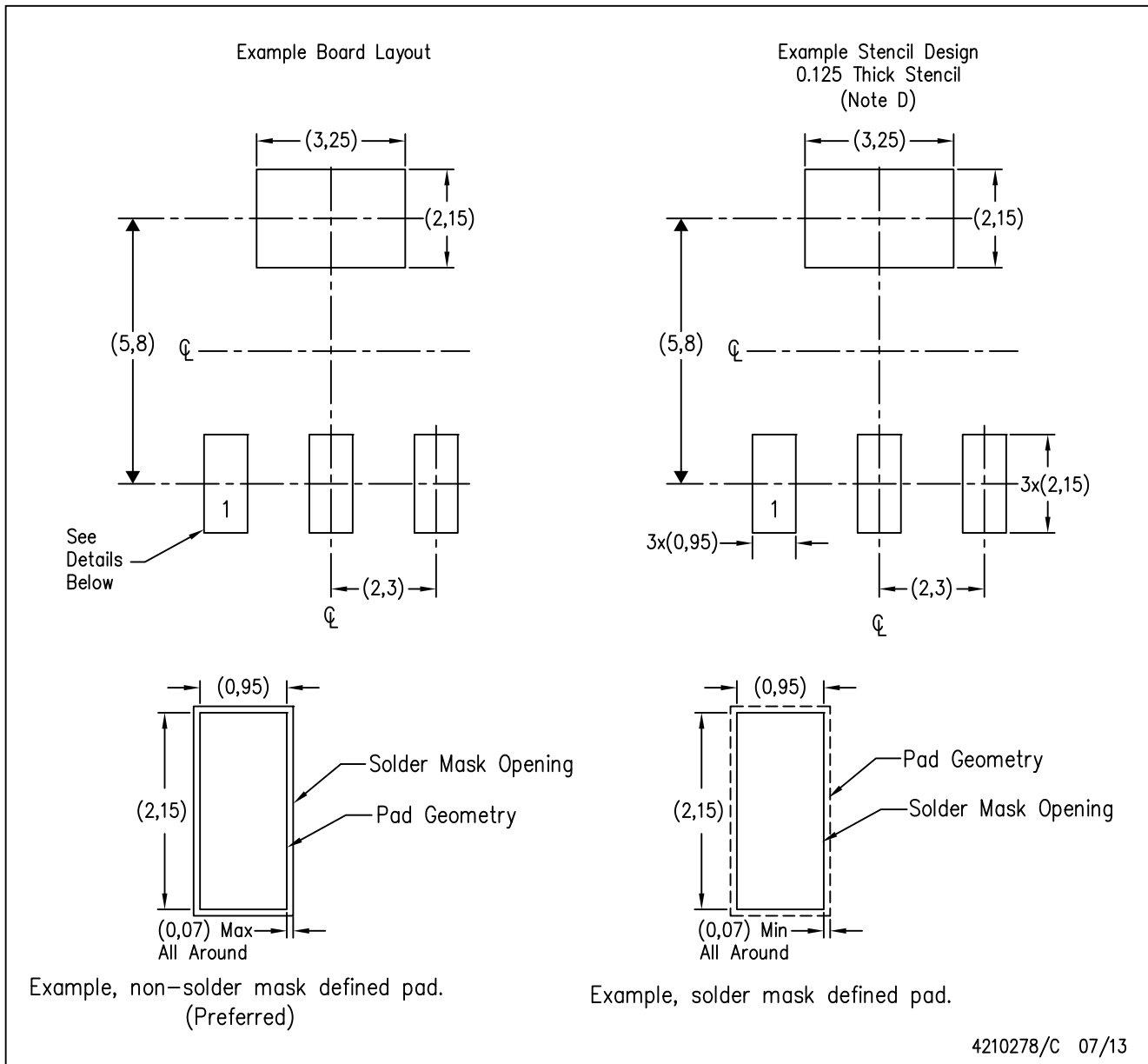

- NOTES:
- A. All linear dimensions are in millimeters.
  - B. This drawing is subject to change without notice.
  - C. Publication IPC-7351 is recommended for alternate designs.
  - D. Laser cutting apertures with trapezoidal walls and also rounding corners will offer better paste release. Customers should contact their board assembly site for stencil recommendations. Refer to IPC 7525 for stencil design considerations.

D (R-PDSO-G8)

PLASTIC SMALL OUTLINE





- NOTES:
- A. All linear dimensions are in inches (millimeters).
  - B. This drawing is subject to change without notice.
  - C. Body length does not include mold flash, protrusions, or gate burrs. Mold flash, protrusions, or gate burrs shall not exceed 0.006 (0,15) each side.
  - D. Body width does not include interlead flash. Interlead flash shall not exceed 0.017 (0,43) each side.
  - E. Reference JEDEC MS-012 variation AA.

LP (O-PBCY-W3)

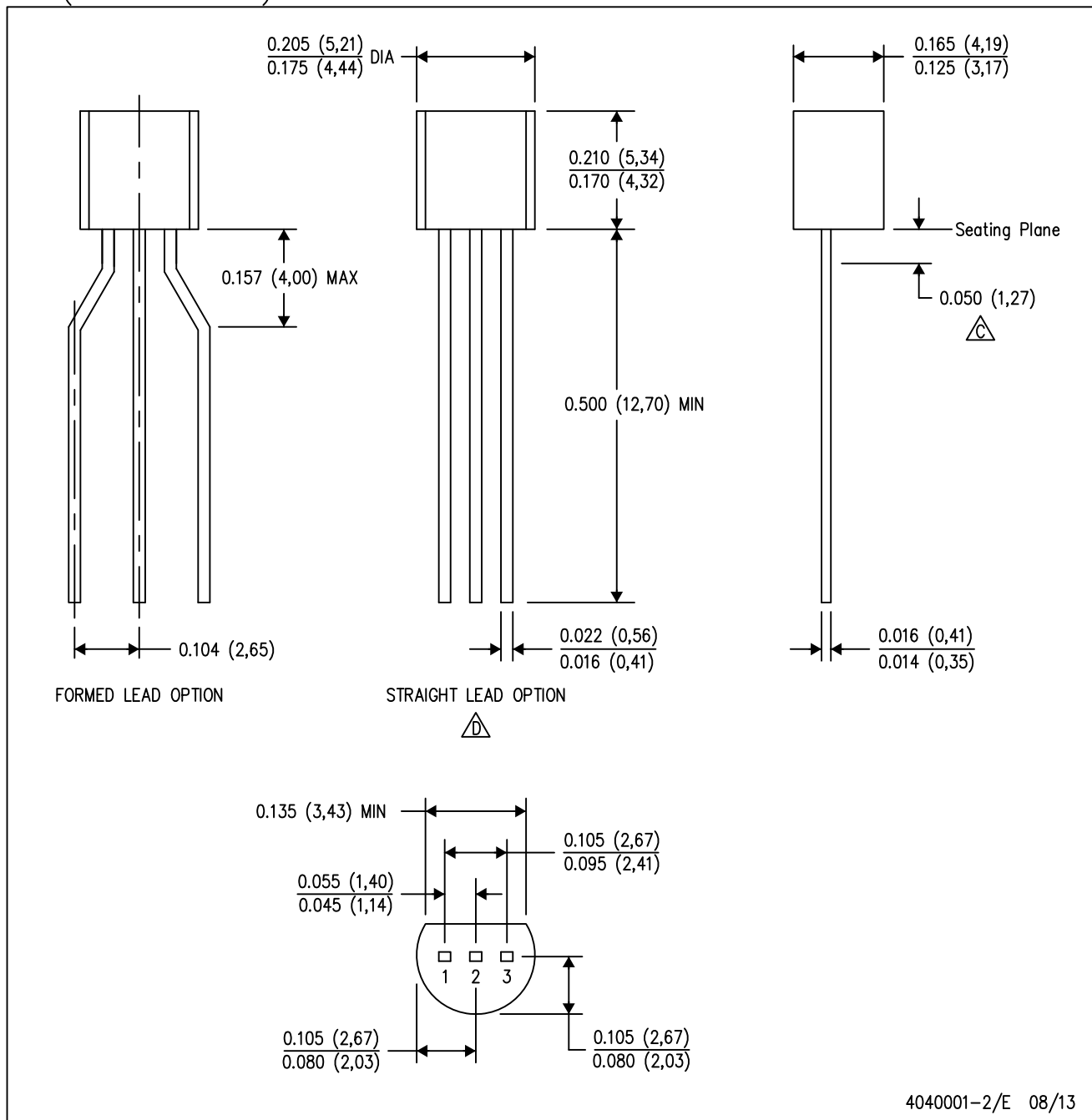
PLASTIC CYLINDRICAL PACKAGE



4040001-2/E 08/13

- NOTES:
- A. All linear dimensions are in inches (millimeters).
  - B. This drawing is subject to change without notice.
  -  Lead dimensions are not controlled within this area.
  -  Falls within JEDEC TO-226 Variation AA (TO-226 replaces TO-92).
  - E. Shipping Method:  
 Straight lead option available in bulk pack only.  
 Formed lead option available in tape & reel or ammo pack.  
 Specific products can be offered in limited combinations of shipping mediums and lead options.  
 Consult product folder for more information on available options.



# MECHANICAL DATA

LP (O-PBCY-W3)

PLASTIC CYLINDRICAL PACKAGE

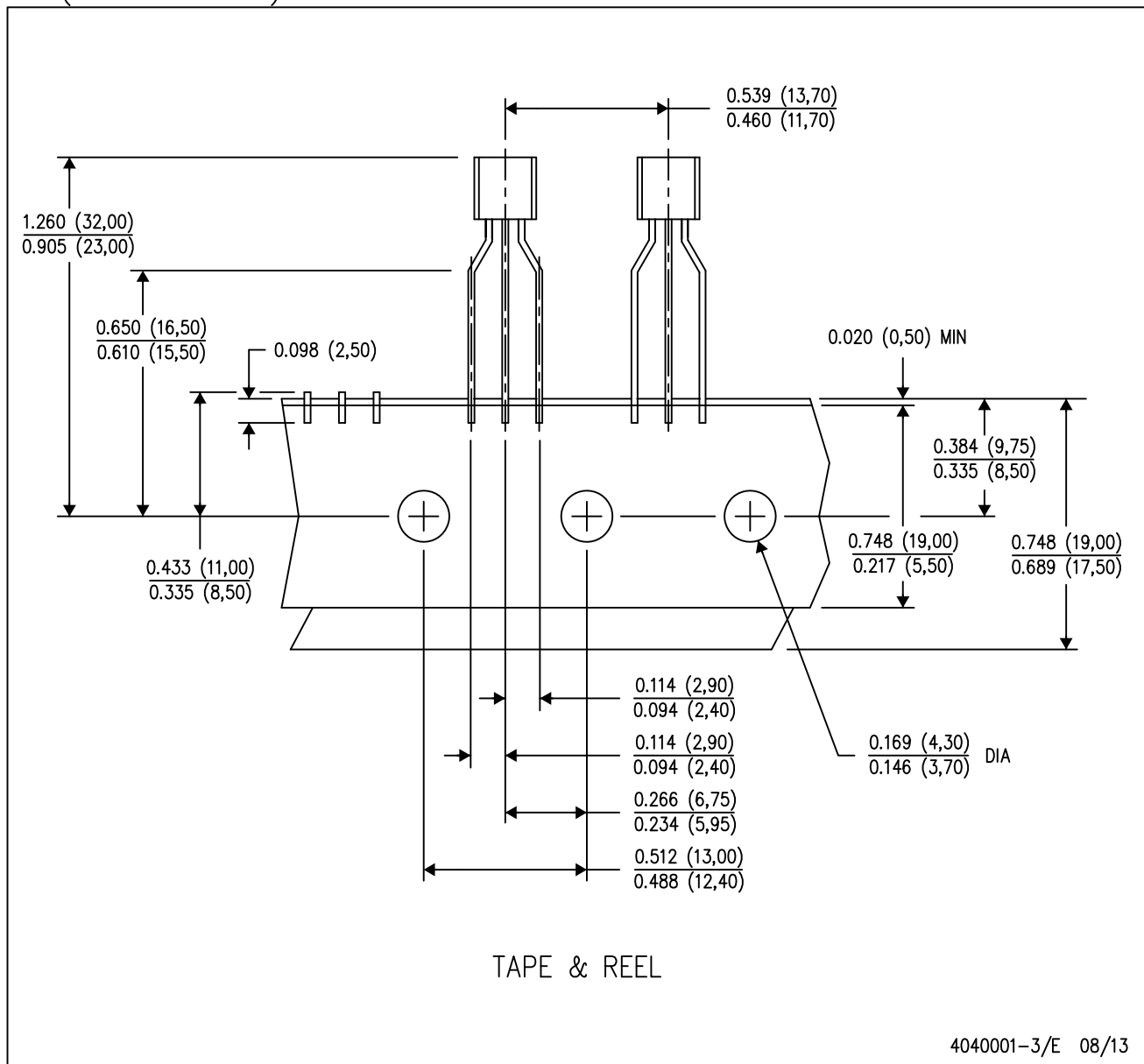

- NOTES:
- All linear dimensions are in inches (millimeters).
  - This drawing is subject to change without notice.
  - Tape and Reel information for the Formed Lead Option package.

## IMPORTANT NOTICE

Texas Instruments Incorporated and its subsidiaries (TI) reserve the right to make corrections, enhancements, improvements and other changes to its semiconductor products and services per JESD46, latest issue, and to discontinue any product or service per JESD48, latest issue. Buyers should obtain the latest relevant information before placing orders and should verify that such information is current and complete. All semiconductor products (also referred to herein as "components") are sold subject to TI's terms and conditions of sale supplied at the time of order acknowledgment.

TI warrants performance of its components to the specifications applicable at the time of sale, in accordance with the warranty in TI's terms and conditions of sale of semiconductor products. Testing and other quality control techniques are used to the extent TI deems necessary to support this warranty. Except where mandated by applicable law, testing of all parameters of each component is not necessarily performed.

TI assumes no liability for applications assistance or the design of Buyers' products. Buyers are responsible for their products and applications using TI components. To minimize the risks associated with Buyers' products and applications, Buyers should provide adequate design and operating safeguards.

TI does not warrant or represent that any license, either express or implied, is granted under any patent right, copyright, mask work right, or other intellectual property right relating to any combination, machine, or process in which TI components or services are used. Information published by TI regarding third-party products or services does not constitute a license to use such products or services or a warranty or endorsement thereof. Use of such information may require a license from a third party under the patents or other intellectual property of the third party, or a license from TI under the patents or other intellectual property of TI.

Reproduction of significant portions of TI information in TI data books or data sheets is permissible only if reproduction is without alteration and is accompanied by all associated warranties, conditions, limitations, and notices. TI is not responsible or liable for such altered documentation. Information of third parties may be subject to additional restrictions.

Resale of TI components or services with statements different from or beyond the parameters stated by TI for that component or service voids all express and any implied warranties for the associated TI component or service and is an unfair and deceptive business practice. TI is not responsible or liable for any such statements.

Buyer acknowledges and agrees that it is solely responsible for compliance with all legal, regulatory and safety-related requirements concerning its products, and any use of TI components in its applications, notwithstanding any applications-related information or support that may be provided by TI. Buyer represents and agrees that it has all the necessary expertise to create and implement safeguards which anticipate dangerous consequences of failures, monitor failures and their consequences, lessen the likelihood of failures that might cause harm and take appropriate remedial actions. Buyer will fully indemnify TI and its representatives against any damages arising out of the use of any TI components in safety-critical applications.

In some cases, TI components may be promoted specifically to facilitate safety-related applications. With such components, TI's goal is to help enable customers to design and create their own end-product solutions that meet applicable functional safety standards and requirements. Nonetheless, such components are subject to these terms.

No TI components are authorized for use in FDA Class III (or similar life-critical medical equipment) unless authorized officers of the parties have executed a special agreement specifically governing such use.

Only those TI components which TI has specifically designated as military grade or "enhanced plastic" are designed and intended for use in military/aerospace applications or environments. Buyer acknowledges and agrees that any military or aerospace use of TI components which have **not** been so designated is solely at the Buyer's risk, and that Buyer is solely responsible for compliance with all legal and regulatory requirements in connection with such use.

TI has specifically designated certain components as meeting ISO/TS16949 requirements, mainly for automotive use. In any case of use of non-designated products, TI will not be responsible for any failure to meet ISO/TS16949.

### Products

Audio	<a href="http://www.ti.com/audio">www.ti.com/audio</a>
Amplifiers	<a href="http://amplifier.ti.com">amplifier.ti.com</a>
Data Converters	<a href="http://dataconverter.ti.com">dataconverter.ti.com</a>
DLP® Products	<a href="http://www.dlp.com">www.dlp.com</a>
DSP	<a href="http://dsp.ti.com">dsp.ti.com</a>
Clocks and Timers	<a href="http://www.ti.com/clocks">www.ti.com/clocks</a>
Interface	<a href="http://interface.ti.com">interface.ti.com</a>
Logic	<a href="http://logic.ti.com">logic.ti.com</a>
Power Mgmt	<a href="http://power.ti.com">power.ti.com</a>
Microcontrollers	<a href="http://microcontroller.ti.com">microcontroller.ti.com</a>
RFID	<a href="http://www.ti-rfid.com">www.ti-rfid.com</a>
OMAP Applications Processors	<a href="http://www.ti.com/omap">www.ti.com/omap</a>
Wireless Connectivity	<a href="http://www.ti.com/wirelessconnectivity">www.ti.com/wirelessconnectivity</a>

### Applications

Automotive and Transportation	<a href="http://www.ti.com/automotive">www.ti.com/automotive</a>
Communications and Telecom	<a href="http://www.ti.com/communications">www.ti.com/communications</a>
Computers and Peripherals	<a href="http://www.ti.com/computers">www.ti.com/computers</a>
Consumer Electronics	<a href="http://www.ti.com/consumer-apps">www.ti.com/consumer-apps</a>
Energy and Lighting	<a href="http://www.ti.com/energy">www.ti.com/energy</a>
Industrial	<a href="http://www.ti.com/industrial">www.ti.com/industrial</a>
Medical	<a href="http://www.ti.com/medical">www.ti.com/medical</a>
Security	<a href="http://www.ti.com/security">www.ti.com/security</a>
Space, Avionics and Defense	<a href="http://www.ti.com/space-avionics-defense">www.ti.com/space-avionics-defense</a>
Video and Imaging	<a href="http://www.ti.com/video">www.ti.com/video</a>

### TI E2E Community

[e2e.ti.com](http://e2e.ti.com)