

AUTOMOTIVE CURRENT TRANSDUCER FLUXGATE TECHNOLOGY

CAB 300-C/SP2



RoHS

Introduction

The CAB family is for battery monitoring applications where high accuracy and very low offset are required.

Features

- Transducer using Fluxgate technology
- Zero offset
- Unlimited over-current capability
- Panel mounting
- Unipolar + 12 V battery power supply
- $T_A = -40\text{ }^\circ\text{C} \dots +105\text{ }^\circ\text{C}$
- Accuracy (over temperature range)
 - $\varepsilon_G =$ Sensitivity error $< 0.5\%$
 - $\varepsilon_L =$ Linearity error $< 0.1\%$
- Output signal:
 - CAN.C (500 kbps)
- Optional internal digital low-pass frequency filter.

Special feature

- Connector type PIN Tyco AMP 1473672-1.

Advantages

- No offset error
- High accuracy
- Low linearity error
- Full galvanic separation.

Automotive applications

- Hybrid and electric vehicle battery pack
- Conventional lead-acid batteries
- Accurate current measurement for battery management applications (SOC, SOH, SOF etc.).

Principle of Fluxgate Transducers

A low-frequency fluxgate transducer is made of a wound core which saturates under low induction.

A current chopper switches the winding's current to saturate the magnetic core alternatively at $\pm B_{max}$ with a fixed frequency.

Fluxgate transducers use the change of the saturation's point symmetry to measure the primary current.

Due to the principle of switching the current, all offsets (electric and magnetic) are cancelled.

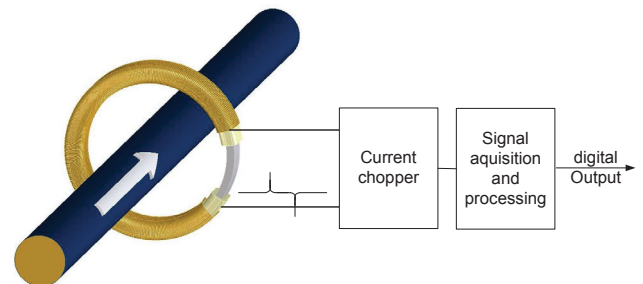

Dimensions CAB 300-C/SP2 (in mm)

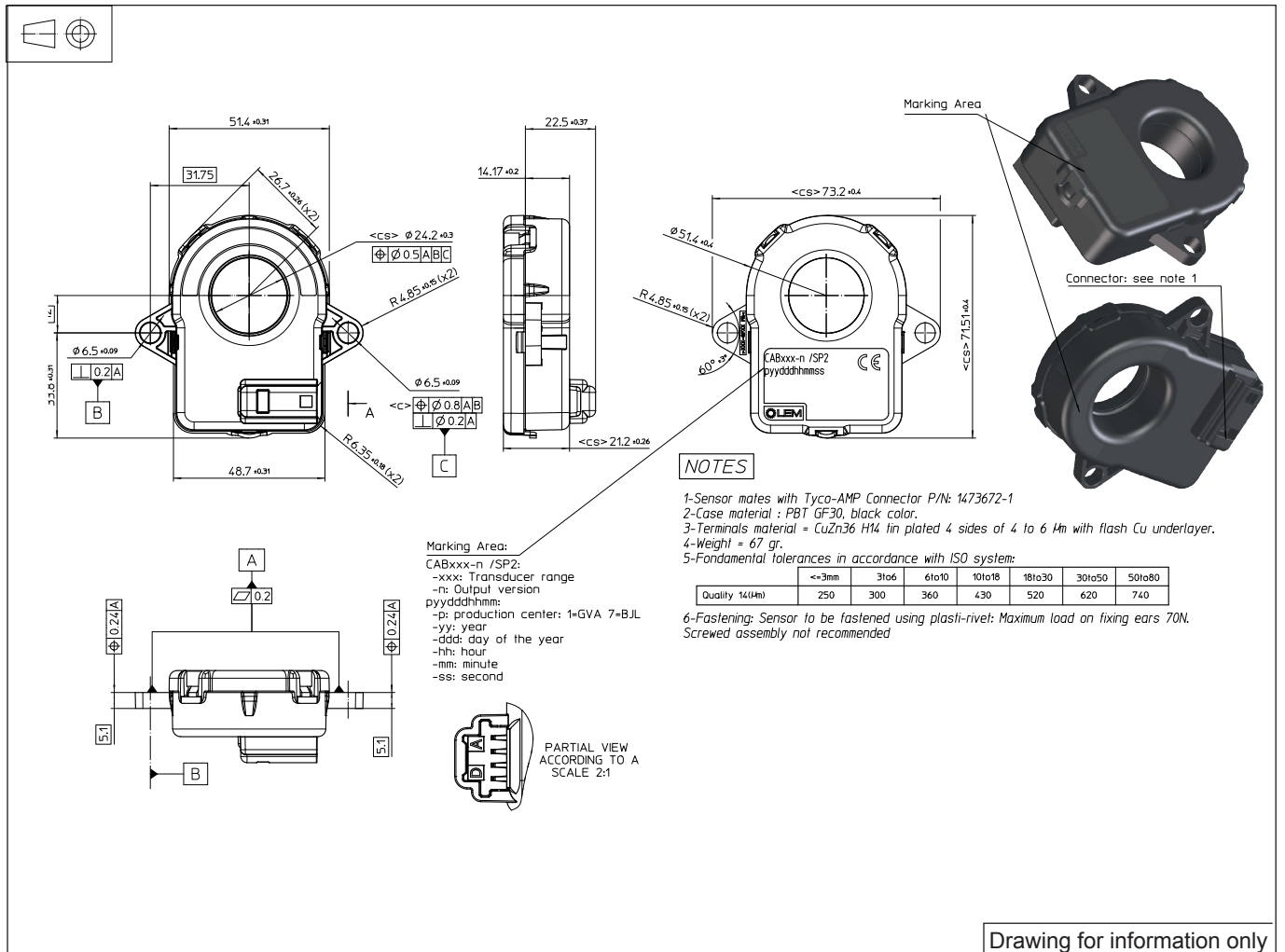

Mechanical characteristics

- Plastic case PBT GF 30
- Magnetic core Nanocrystallin
- Mass 67 g
- Electrical terminal coating Tin plated

Mounting recommendation

- Connector type Tyco-AMP P/N: 1 473672-1

Connection

Pin Out	
A	CAN-L
B	CAN-H
C	GND
D	U_c

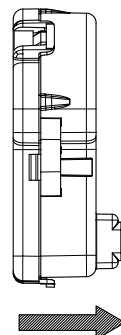
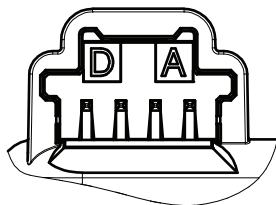

I_p (positive primary current direction)

CAB 300-C/SP2

Absolute ratings (not operating)

Parameter	Symbol	Unit	Specification	Conditions
Load dump over-voltage	U_C	V	32	400 ms
Over-voltage	U_C	V	24	1 minute
Reverse polarity	U_C	V	-50	
Minimum supply voltage	$U_{C\ min}$	V	6	Continuous
Maximum supply voltage	$U_{C\ max}$	V	18	Continuous
Electrostatic discharge voltage	U_{ESD}	KV	4	Pins
Insulation resistance	$R_{is\ min}$	MΩ	500	500 V-ISO 16750-2
Rms voltage for AC insulation test, 50 Hz, 1 min	U_d	KV	2.5	50 Hz, 1 min
Creepage distance	d_{Cp}	mm	7.2	
Clearance	d_{Cl}	mm	6.95	

Operating characteristics in nominal range (I_{PN})

Parameter	Symbol	Unit	Specification			Conditions
			Min	Typical	Max	
Electrical Data						
Primary current, measuring range	I_{PM}	A	-350		350	
Supply voltage	U_C	V	8	13.5	16	full accuracy
Current consumption @ $I_p = 0$ A	I_C	mA		30		@ $U_c = 13.5$ V @ 25 °C
Current consumption @ $I_p = 350$ A	I_C	mA		80		I_C is a function of I_p ; @ $U_c = 13.5$ V @ 25 °C
Performance Data						
Linearity error	ϵ_L	%	-0.1		0.1	in temperature range
Offset current @ $I_p = 0$ A	I_o	mA	-10		10	min/max values @ 3 sigma; 8 V to 16 V; from -40 °C to 105 °C
Overall accuracy @ $I_p = \pm 350$ A	X_G	mA	-1750		1750	min/max values @ 3 sigma; 8 V to 16 V; from -40 °C to 105 °C
Phase shift	$\Delta\phi$	ms		1.5		without digital filtering
Ambient operating temperature	T_A	°C	-40		105	

CAB 300-C/SP2

Can Output

CAN Interface characteristics:

- CAN High Speed, SAE CAN Class C
- High speed CAN transceiver: TJA1040
- CAN protocol: Version 2.0A/B
- Byte order: big endian (Motorola)

Parameter	Unit	Value	Comments
CAN speed	kbps	500	possible configuration: 125 to 1000
CAN oscillator tolerance	%	0.27	

Message Description	ID	Name	Data Length (Nb bytes)	Type of frame	Message launch type	Signal Description	Signal Name	Start Bit	End Bit
Return Current I_p (mA): Filtered value	0x3C2	CAB300_IP	8	Standard	Cyclic tranceived message 10ms cycle	I_p Value: 8000000H=0mA, 7FFFFFFFH=-1mA, 8000001H=1mA	IP_VALUE	0	31
						b0: Error Information (0=Normal, 1: failure)	ERROR_INDICATION	32	32
						b7 to b1: RxQuality (0 to 100%)	ERROR_INFORMATION	33	39
						Vacant bits (fixed to 0)	VACANT_DATA_3BYTES	40	63
Start/Stop CAN TX	0x6F0	TX_Control	8	Standard	Asynchronous received message	Set to 0x02	PCI	0	7
						0x28 (Stop CAN) / 0x29 (Start CAN)	BS	8	15
						Set to 0x02	Stmin	16	23
						Set to 0xFFFF FFFF	VACANT_DATA_5BYTES	24	63

Diagnostic Trouble Code (DTC)

FAILURE MODE	I_p VALUE	ERROR INDICATION	ERROR INFORMATION
Error on dataflash CRC	FFFF FFFF	1	0x41
Fluxgate running at high frequency (<2.5 kHz) for more than 10 ms	FFFF FFFF	1	0x42
Fluxgate not oscillating for more than 20ms	FFFF FFFF	1	0x43
CAB entered in fail safe mode	FFFF FFFF	1	0x44
Signal not available for more than 100ms	FFFF FFFF	1	0x46
Bridge voltage protection	FFFF FFFF	1	0x47

CAB 300-C/SP2

Accuracy curves

I_c @ 25 °C at 13.5 V

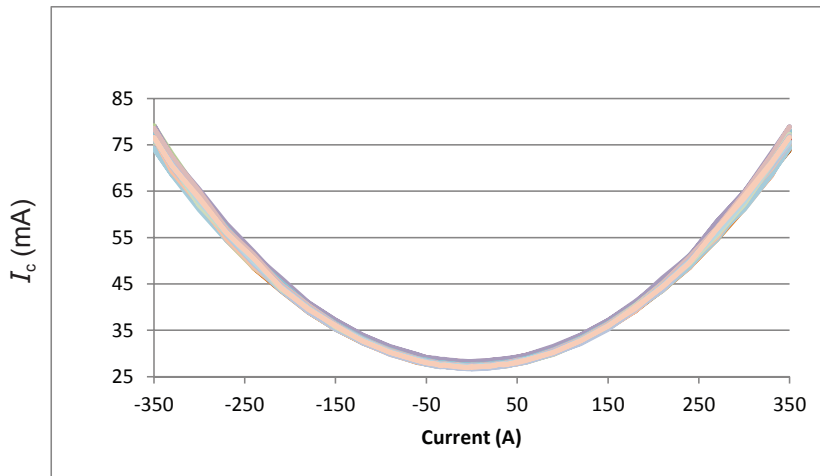

x_G over temperature range at ± 3 sigma

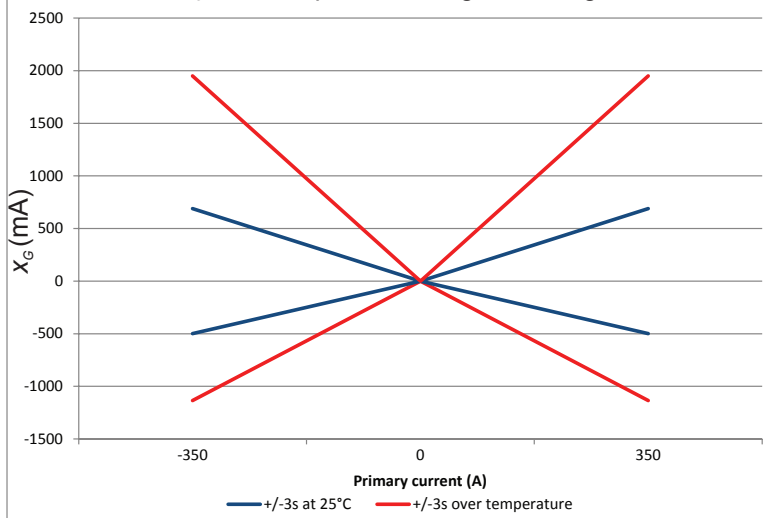

Statistic of Global error x_G at I_{PN} ($U_c = 13.5$ V)

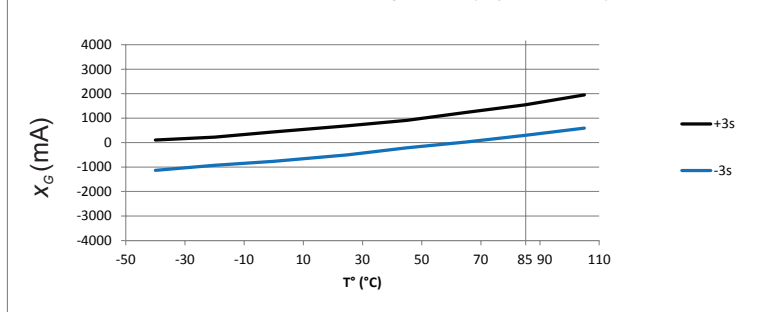

CAB 300-C/SP2

CAB Test table

Test	Test standard	Procédure
Environmental test		
Shipping/Storage Temperature Exposure	ISO 16750-4	164 hours, -40 °C/+85 °C, power off, slope 0.6 °C/min
Low Temperature Operating Endurance		120 hours, -40 °C, power on
High Temperature Operating Endurance		4752 hours, 85 °C, power on
Powered Thermal Cycle Endurance	ISO 16750-4	540 cycles/100 min: -40 °C (20 min), +85 °C (20 min), Slope 4 °C/min: 900 hours
Thermal Shock		-40 °C (20 min soak) / 85 °C (20 min soak), 1000 cycles, with connectors => 667 hours (28 days)
Thermal Humidity Cycle	IEC 60068-2-38	240 hours, -10 °C/+65 °C, 93% humidity
High Temperature Operating Endurance	IEC 60068-2-67	85 °C, 85% humidity, 1000 hours Performance after test: $I_o \leq 20 \text{ mA}$, $X_g \leq 3000 \text{ mA}$
Vibration		5 Hz to 1000 Hz (table 6-10), 20 hours / axis, 3 axis + -40 °C / +85 °C during 8 hours and 25 °C during 12 hours
Mechanical Shock	ISO 16750-3	500m/s ² , 10 each direction (60 total) Half sine pulse
Package Drop		With final packaging 1m, 1 bottom, 4 bottom edges, 4 bottom corners => total 9 drops 1 meter on concrete floor.
Handling Drop	ISO 16750-3	1 fall in one direction for each sensor, from 1 meter on concrete floor
Dust (and other solid intrusion)	ISO 20653	IP category: 4
Water intrusion	ISO 20653	IP category: 1
Dew formation test	IEC 60068-2030	
Mixed Flowing Gas	IEC 60068-2-60	
Chemical exposure outside cabin	ISO 16750-5	24 hours / fluid; see PV test report for list of fluids

CAB 300-C/SP2

CAB Test table

EMC Test		
CISPR 25 Conducted RF Emissions-Voltage on	CISPR25	Narrow band: 0.15 to 108 MHz Wide band: 0.15 to 200 MHz
CISPR 25 Conducted RF Emissions-Current on all	CISPR25	Narrow band: 0.15 to 108 MHz Wide band: 0.15 to 200 MHz
CISPR 25 Radiated Emissions	CISPR25	30 to 1000 MHz
Bulk Current Injection (BCI) Test	ISO 11452-4	According to ISO 11452-4
ALSE with a Ground Plane	ISO 11452-2	According to ISO 11452-2
Transient Disturbances Conducted along Supply	ISO 7637-2	According to ISO 7637-2
Transient Disturbances Conducted along I/O	ISO 7637-3	According to ISO 7637-3
Handling Test	ISO 10605	Test method: IEC 61000-4-2 (2008) pins: ± 4 KV case: ± 8 KV
Operating Test	IEC 61000-4-2	Test method: IEC 61000-4-2 (2008) Indirect contact discharge: ± 8 KV Air discharge: ± 20 KV
Impulse Noisy Test		± 2 KV noise simulator, on each line
Fast Transient Noise Test		± 2 KV fast transient simulator, on each line
Electrical Test		
Supply Voltage Range		8 V to 16 V; from -40 °C to 105 °C
Supply Voltage Ripple	SAE J1113-2	According to SAE J1113-2
Supply Voltage Drop Out		Supply Voltage Drop from 11 V to 0 V and return to 11 V Drop duration increase from 10 μ s to 1 ms (sensor fonctionnal) and from 1 ms to 2 s (sensor not damaged)
Supply Voltage Dips		Supply voltage Dips from 11 V to dip voltage and return to 11 V Dips voltage are 5.5 V, 5 V, 4.5 V, 4 V, 3.5 V and 3 V Dips duration for each level are 100 μ s-1 ms (sensor fonctionnal) and 1 ms - 500 ms (sensor not damaged)
Slow decreases and increase	ISO 16750-2 (2004)	According to ISO 16750-2
Defective regulation (full fielded alternator)		24 V, 1 minute
Jumps Start		18 V, 60 minutes, @ 65 °C
Load Dump		32 V, 400 ms; 5 pulses
Reverse Supply Voltage	ISO 16750-2 (2004)	-16 V, 1 minute

PERFORMANCES PARAMETERS DEFINITIONS

Linearity:

The maximum positive or negative discrepancy with a reference straight line I_p value = $f(I_p)$

Unit: linearity (%) expressed with full scale of I_{PN} .

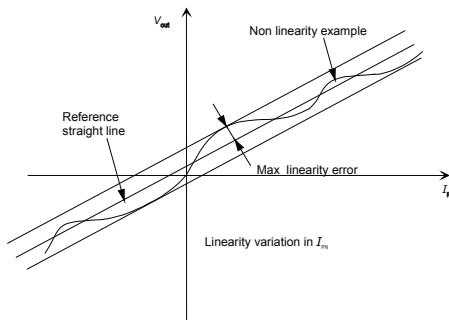

Accuracy:

Accuracy is the maximum error between measured value and a reference value.

Phase delay:

The phase delay is the maximum time difference between CAN frame sending and internal sampling of primary current.