



产品承认书 / SPECIFICATION FOR APPROVAL

客户名称/CUSTOMER : Ozdisan
 客户料号/CUSTOMER P/N. :
 样品编号/SAMPLE NO. :
 产品型号/MODEL NO. : DA06025S12M
 详细描述/DESCRIPTION. : 60×60×25mm
 制作日期/ISSUE DATE. : 2015-05-29



客户确认签名 / CUSTOMER'S AUTHORIZED SIGNATURE:

签名/SIGNATURE

时间/TIME

感谢您选择我公司产品，如果确认符合贵司要求，劳烦将首页签章回传到我公司。
 Thanks for your interest in our products. Please sign and return this page to us after confirming your approval.

版本记录 / REVISION RECORD

版本/REV	修改描述/REVISION DESCRIPTION	日期/TIME
A01	首次制作	15.05.29

DRAWN.BY	CHECKED.BY ENG	APPROVED.BY VM	

Shenzhen Huaxia Hengtai Electronic Co.,Ltd
 No.15 Lingwu Industrial Road Junzibu Guanlan Baoan District Shenzhen Guangdong China
 Tel:86-755-27996118 Fax:86-755-27189911 URL: www.szhxht.com

参数规格(PRODUCT SPECIFICATION)

A.一般规格(General Specification)

项目/ITEM		规格.条件/Specification Condition	
01	型 号 / Part No.	DA06025S12M	
02	外型尺寸 / Dimension	60×60×25mm	
03	额定电压 / Rated Voltage	12VDC	
04	启动电压 / Start-up Voltage	7VDC	25°C Switch power ON/OFF
05	操作电压 / Operating Voltage	7.0~13.8VDC	
06	额定转速 / Rated Speed	4000rpm	±10%
07	额定电流 / Rated Current	0.14A	
08	额定功率 / Rated Power	1.68W	
09	安规电流 / Safety Current	0.18A	
10	最大风量 / Max Airflow	19.15	CFM
		0.54	m ³ /min
11	最大静压 / Max Static Pressure	0.17	Inch-H ₂ O
		4.32	mm-H ₂ O
12	寿命预估 / Life Expectancy	30000hrs at 40°C	
13	噪音测试/Noise Level	32.0dB Max	E. 噪音测试条件/ E. Noise Measure Condition
14	马达极数/ No. of Pole	4 极/Poles	
15	回转方向/ Rotating Direction	顺时针/Clockwise (从标签面看/From Label side)	

B.电气规格(Electrical Specification)

项目/ITEM		规格.条件/Specification. Condition	
01	锁定扇叶保护功能 Locked Rotor Protection	<input checked="" type="checkbox"/>	安规条件/ Safety Condition
		<input type="checkbox"/>	额定电压, 锁住扇叶 1 秒, 自动断电后, 2~6 秒后尝试重新启动/Auto power off after locked at rated voltage for 1sec After auto power off ,circuit attempt restart in 2 to 6sec
02	极性保护 Polarity Protection	<input checked="" type="checkbox"/>	Vcc 与 GND 反接时, 不导通 Open circuit when Vcc&GND are exchanged
		<input type="checkbox"/>	Vcc 与 GND 反接时, 5 秒内不烧毁 / Circuit won't be burned within 5 seconds when Vcc &GND are exchanged
		<input type="checkbox"/>	无反接保护 No Polarity Protection
03	绝缘阻抗 Insulation Resistance	10MΩ 裸线与外框间测量, 500VDC/min 10MΩ Between unshielded wire and frame at 500VDC/min	
04	绝缘耐压 Dielectric Strength	5mA Max/ 裸线与外框间测量, 500VAC/min 5mA Max/ Measured b/w lead wire(+)and frame at 500VAC/min	
05	特殊功能 Special Function	<input type="checkbox"/>	软启动/Soft Start
		<input type="checkbox"/>	限流 /Current Limiter

C.主要材料,零件规格(Main Materials, Parts Specification)

01	轴 承/Bearing	<input type="checkbox"/> 双滚珠轴承 (Dual Ball Bearing)	<input checked="" type="checkbox"/> 含油轴承 (Sleeve Bearing)		
02	外框材质/Frame	<input checked="" type="checkbox"/> PBT of UL94V-0.	<input type="checkbox"/> Die-cast Aluminum Alloy		
03	扇叶材质/Impeller	<input checked="" type="checkbox"/> PBT of UL94V-0.	<input type="checkbox"/> Steel		
04	绝缘套/Bobbin	<input checked="" type="checkbox"/> PBT of UL94V-0.			
05	导线/Lead Wire	<input checked="" type="checkbox"/> Red(+)	<input checked="" type="checkbox"/> Black(-)	<input type="checkbox"/> Blue (PWM)	UL1007 24#
		<input type="checkbox"/> Yellow(FG)	<input type="checkbox"/> White(RD)	2 wires 300±10mm	
06	端子/Connector	无/No			
07	套管/Tube	无/No			
08	防护处理/ IP level	无/No			

D.环境测试/Environmental Specification

项目/ITEM		规格.条件/Specification. Condition	
01	运转温度、湿度范围 Operating Temp. Range	温度/Temperature	: -10 °C ~70°C
		湿度/Humidity	:15%~ 90% RH (Frost Eliminated)
02	保存温度、湿度范围 Storage Temp. Range	温度/Temperature	: -40 °C ~70°C
		湿度/Humidity	:15%~ 90% RH (Frost Eliminated)
03	包装振动测试 Packing Vibration Test	Packing condition: X, Y, Z 3 directions, 1.1g load vibration test for 30 min.	
04	包装跌落冲击测试 Packing Shock Proof Test	1 corner, 3 edges, 6 faces natural drop from 60cm high, packed	

E.噪音测试条件/Noise Measure Condition

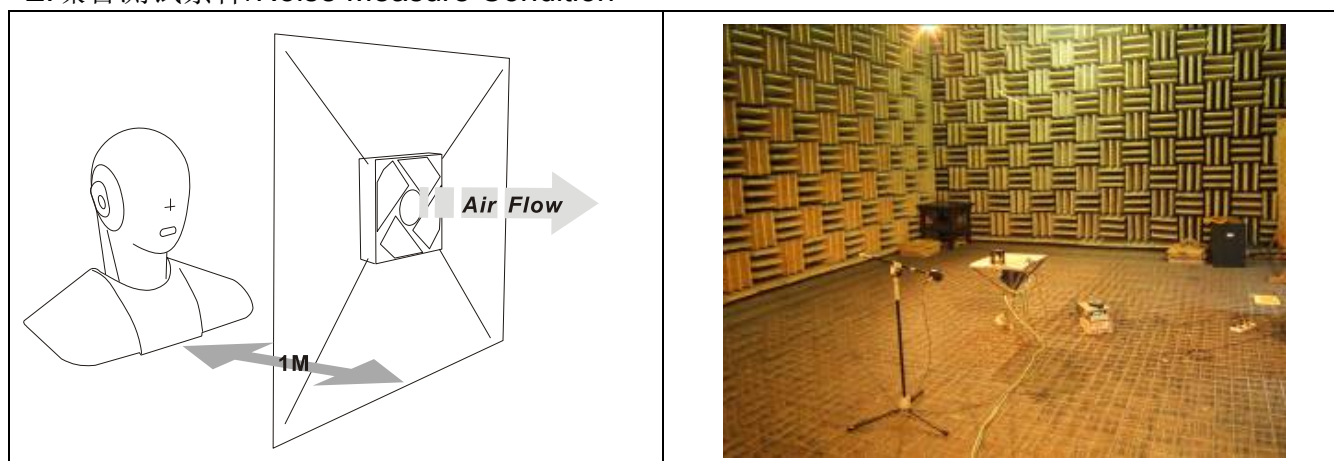

测量系统/Measurement Systems

1. ANECHOIC Room Noise Measurement System
2. Digital Head Measurement System, 16-bit version
3. Specifications:ISO 3744,ISO 3745,ISO 7779, CNS6753,JIS 8346
4. Background Noise:<18dB(A)

F.商标 (Label Marking)

	型号/Model No.	DA06025S12M
	额定电压/Rated Voltage	12VDC
	安规电流/ Safety Current	0.18A
	标签尺寸/Label Size	Φ30.0mm
	商标颜色/Label Color	绿色/Green
	安规/Safety Approval	UL CE TUV
	附加码/Appendix Code	无/No

G.外形尺寸 (Outline Dimension)

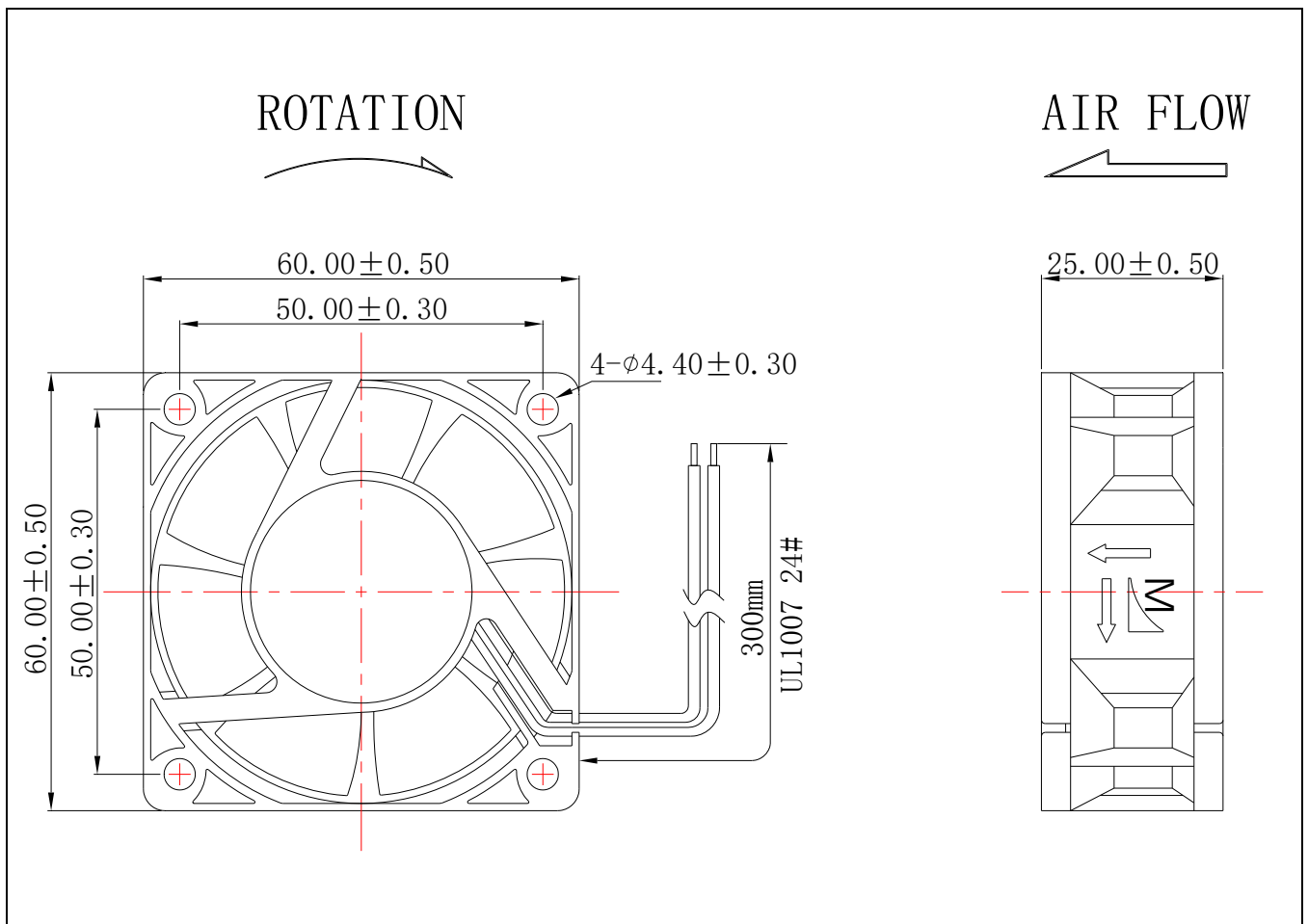

注意事项/Note:

1. 我们提供的产品应在规格书指定的条件内使用，如果您的应用超出规格极限，我们对此不保证产品质量。
Our products should be used within the specification appointed condition, so we will not guarantee this product quality if your application exceeds the limitations outlined in this specification.
2. 除非事先通知我们所需求参数，否则出货产品与此份规格书一致，未在此份规格书中指定的参数与贵公司最终承认的样品相同。Product will be shipped in accordance with this specification unless we has been previously notified of parameters requiring exception, if parameters which are not specified in this specification.
3. 不适当的安装可能产生刺耳的共振，振动和噪音，安装时，请不要在安装点用力过度或用力不均以免造成振动或噪音。在安装点装置减振器，可有效降低噪音及振动。Improper mounting may cause harsh resonance, vibration and noise. Please mount this fan motor properly without applying excessive or uneven force at the mounting points to avoid vibration and noise. Dampers at the mounting points can reduce noise and vibrations greatly.
4. 建议安装风扇保护罩，以免对人员造成意外伤害。Please use fan guards to avoid personal accidental injuries.
5. 除非IP等级中有特殊说明，否则该款风扇只能在正常环境下操作。Unless this fan motor is specified for use in abnormal environments designated by IP rating level, this fan is designed to operate under normal environmental conditions.
6. 请避免将M-FAN系列产品接触有毒物质 如：（有机物、氰、福尔马林、苯酚等）。以及在腐蚀性气体环境中使用 如：（硫化氢、二氧化硫、二氧化氮等）。Please avoid operating M-FAN's products in poisonous material(organic, cyanogens, formalin, phenol, etc.)or corrosive gas environment(H₂S, SO₂, NO₂,etc.)
7. 当风扇在灰尘环境中使用时，请在风扇进风口处安装过滤装置以延长风扇使用寿命。Please use filters to clean the air-intake in very dusty air environments for extended fan life.
8. 在保证产品性能及寿命不变，或者得以提升的条件下。除非事先约定，我们保留使用同等规格多种来源零件的权利，原材料和结构的变更不做预先通知。Unless prior agreement, We reserve the right to use components with equivalent specifications from multiple sources, so material and construction are subject to change without advance notice.
9. 请确保风扇在规定的温湿度储存环境中，如果风扇存储6个月以上，我们建议客户测试风扇功能后再使用。Always ensure that fans are stored according to the storage temperatures specified. Do not store in a high humidity environment. If the fans are stored for more than 6 months, we recommend functional testing before using.
10. 确定在连接和断开连接器之前关掉电源，避免产生电子零件短路。Make sure to turn off the power before connection or disconnecting the connectors. This may cause short of electronic parts.