

Standard Rectifier Module

$$V_{RRM} = 2 \times 1200 \text{ V}$$

$$I_{FAV} = 140 \text{ A}$$

$$V_F = 1.11 \text{ V}$$

Phase leg

Part number

MDMA140P1200TG

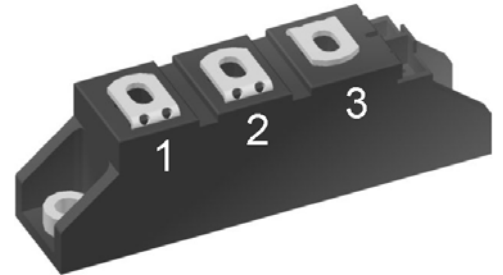

Backside: isolated

 E72873

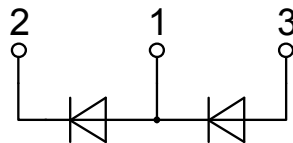

Features / Advantages:

- Package with DCB ceramic
- Improved temperature and power cycling
- Planar passivated chips
- Very low forward voltage drop
- Very low leakage current

Applications:

- Diode for main rectification
- For single and three phase bridge configurations
- Supplies for DC power equipment
- Input rectifiers for PWM inverter
- Battery DC power supplies
- Field supply for DC motors

Package: TO-240AA

- Isolation Voltage: 4800 V~
- Industry standard outline
- RoHS compliant
- Height: 30 mm
- Base plate: DCB ceramic
- Reduced weight
- Advanced power cycling

Rectifier				Ratings			
Symbol	Definition	Conditions		min.	typ.	max.	Unit
V_{RSM}	max. non-repetitive reverse blocking voltage					1300	V
V_{RRM}	max. repetitive reverse blocking voltage					1200	V
I_R	reverse current	$V_R = 1200\text{ V}$	$T_{VJ} = 25^\circ\text{C}$			100	μA
		$V_R = 1200\text{ V}$	$T_{VJ} = 150^\circ\text{C}$			3.5	mA
V_F	forward voltage drop	$I_F = 140\text{ A}$	$T_{VJ} = 25^\circ\text{C}$			1.18	V
		$I_F = 280\text{ A}$				1.43	V
		$I_F = 140\text{ A}$	$T_{VJ} = 125^\circ\text{C}$			1.11	V
		$I_F = 280\text{ A}$				1.41	V
I_{FAV}	average forward current	$T_C = 100^\circ\text{C}$ rectangular	$T_{VJ} = 150^\circ\text{C}$			140	A
V_{FO}	threshold voltage	} for power loss calculation only				0.78	V
r_F	slope resistance					2.2	m Ω
R_{thJC}	thermal resistance junction to case					0.23	K/W
R_{thCH}	thermal resistance case to heatsink				0.20		K/W
P_{tot}	total power dissipation			$T_C = 25^\circ\text{C}$		540	W
I_{FSM}	max. forward surge current	$t = 10\text{ ms}; (50\text{ Hz}), \text{ sine}$	$T_{VJ} = 45^\circ\text{C}$			2.80	kA
		$t = 8,3\text{ ms}; (60\text{ Hz}), \text{ sine}$	$V_R = 0\text{ V}$			3.03	kA
		$t = 10\text{ ms}; (50\text{ Hz}), \text{ sine}$	$T_{VJ} = 150^\circ\text{C}$			2.38	kA
		$t = 8,3\text{ ms}; (60\text{ Hz}), \text{ sine}$	$V_R = 0\text{ V}$			2.57	kA
I^2t	value for fusing	$t = 10\text{ ms}; (50\text{ Hz}), \text{ sine}$	$T_{VJ} = 45^\circ\text{C}$			39.2	kA ² s
		$t = 8,3\text{ ms}; (60\text{ Hz}), \text{ sine}$	$V_R = 0\text{ V}$			38.1	kA ² s
		$t = 10\text{ ms}; (50\text{ Hz}), \text{ sine}$	$T_{VJ} = 150^\circ\text{C}$			28.3	kA ² s
		$t = 8,3\text{ ms}; (60\text{ Hz}), \text{ sine}$	$V_R = 0\text{ V}$			27.5	kA ² s
C_J	junction capacitance	$V_R = 400\text{ V}; f = 1\text{ MHz}$	$T_{VJ} = 25^\circ\text{C}$		116		pF

Package TO-240AA			Ratings			
Symbol	Definition	Conditions	min.	typ.	max.	Unit
I_{RMS}	RMS current	per terminal			200	A
T_{VJ}	virtual junction temperature		-40		150	°C
T_{op}	operation temperature		-40		125	°C
T_{stg}	storage temperature		-40		125	°C
Weight				90		g
M_D	mounting torque		2.5		4	Nm
M_T	terminal torque		2.5		4	Nm
$d_{Sppl/App}$	creepage distance on surface striking distance through air	terminal to terminal	13.0	9.7		mm
$d_{Spb/Apb}$		terminal to backside	16.0	16.0		mm
V_{ISOL}	isolation voltage	t = 1 second			4800	V
		t = 1 minute	50/60 Hz, RMS; $I_{ISOL} \leq 1$ mA		4000	V

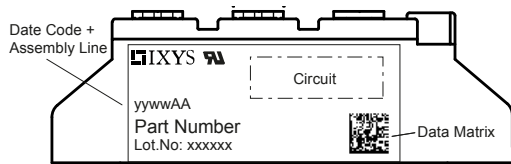

Part number

- M = Module
- D = Diode
- M = Standard Rectifier
- A = (up to 1800V)
- 140 = Current Rating [A]
- P = Phase leg
- 1200 = Reverse Voltage [V]
- TG = TO-240AA

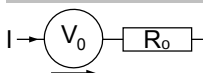
Ordering	Part Number	Marking on Product	Delivery Mode	Quantity	Code No.
Standard	MDMA140P1200TG	MDMA140P1200TG	Box	6	512703

Equivalent Circuits for Simulation
** on die level*
 $T_{VJ} = 150\text{ °C}$

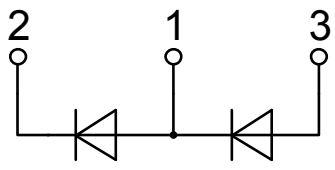
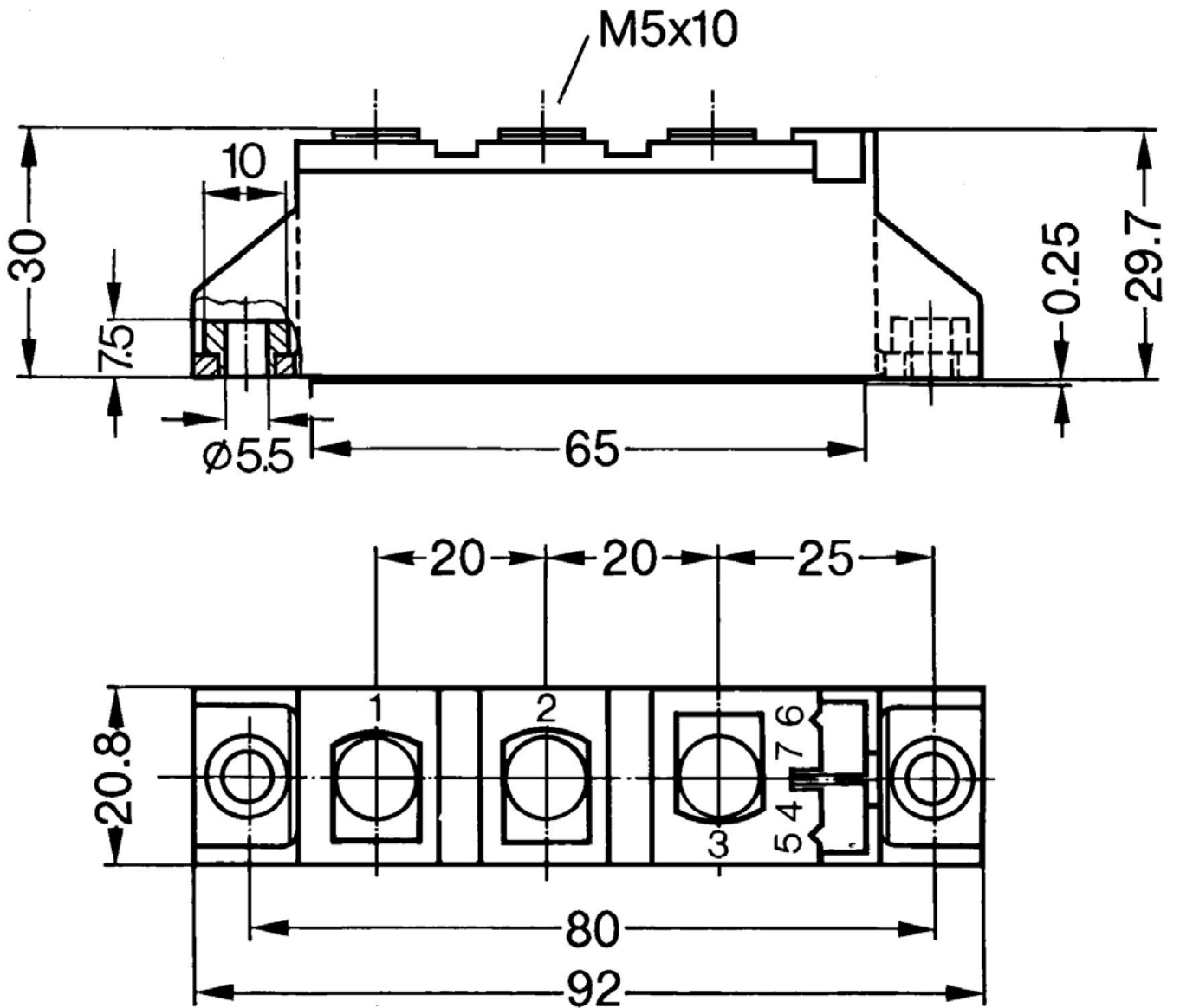
Rectifier

$V_{0\max}$	threshold voltage	0.78	V
$R_{0\max}$	slope resistance *	1	mΩ



Rectifier

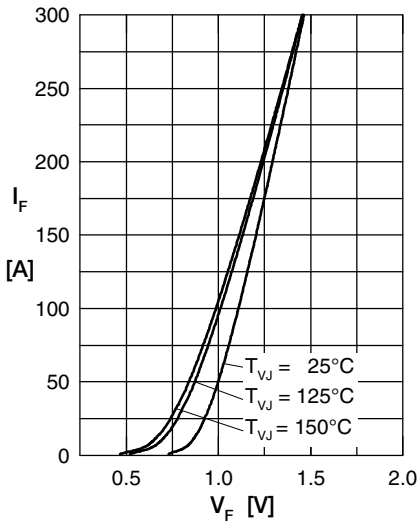

Fig. 1 Forward current versus voltage drop per diode

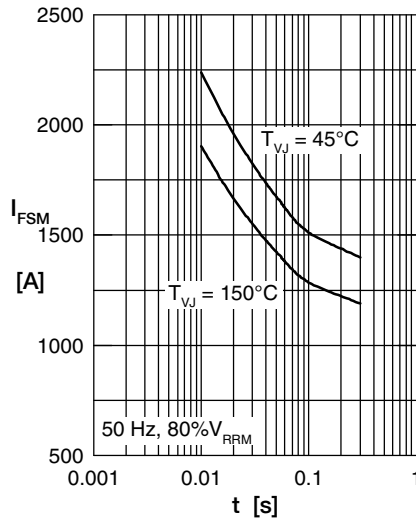

Fig. 2 Surge overload current vs. time per diode

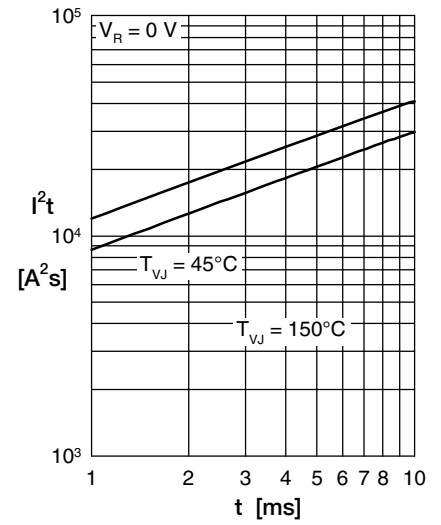

Fig. 3 I^2t versus time per diode

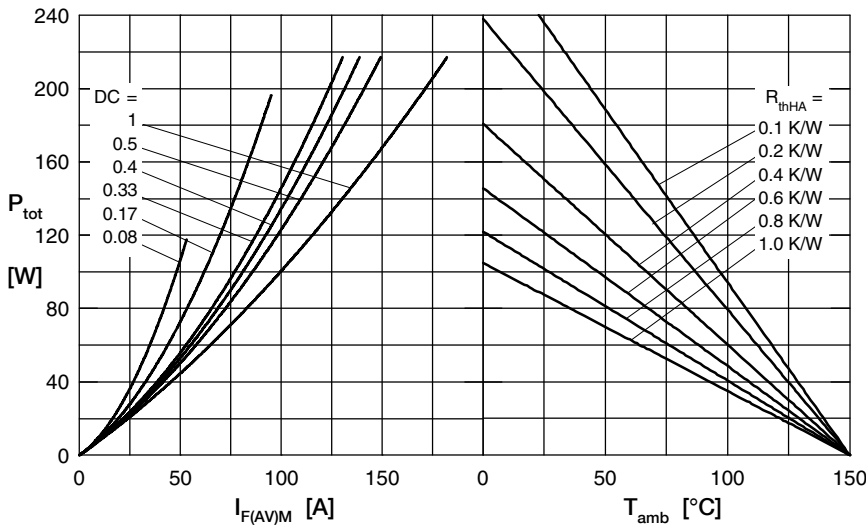

Fig. 4 Power dissipation vs. forward current and ambient temperature per diode

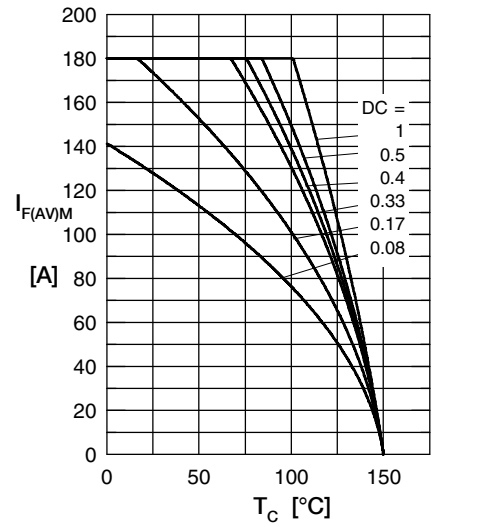

Fig. 5 Max. forward current vs. case temperature per diode

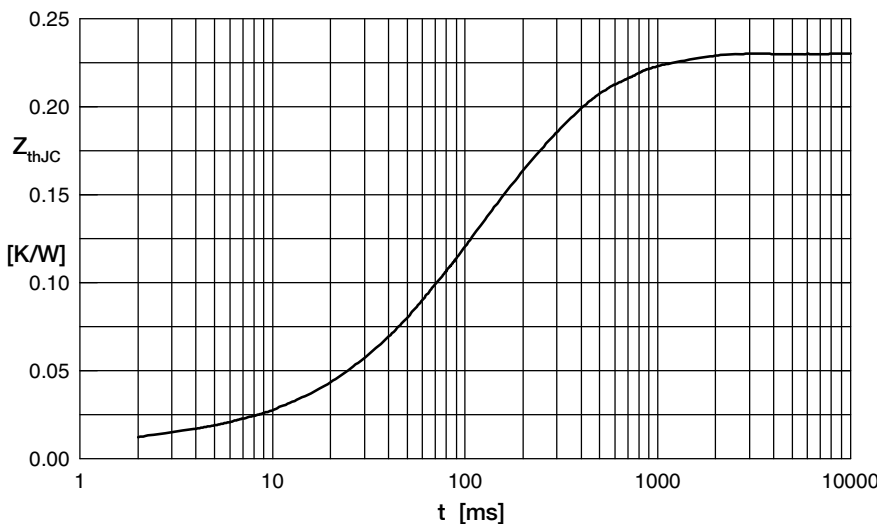

Fig. 6 Transient thermal impedance junction to case vs. time per diode

Constants for Z_{thJC} calculation:

i	R_{thi} (K/W)	t_i (s)
1	0.01	0.001
2	0.05	0.050
3	0.12	0.150
4	0.05	0.500