

STM3210C-EVAL demonstration firmware

Introduction

This user manual describes the demonstration firmware running on the STM3210C-EVAL evaluation board, which can be used to evaluate the capabilities of connectivity line STM32F107xx microcontrollers and on-board peripherals.

In case the STM3210C-EVAL board was not factory-programmed or the demonstration application was erased, you can reprogram it by following the steps described in [Section 2.5](#).

The STM3210C-EVAL board comes with a USB Flash disk preprogrammed with audio and image resources used by the demonstration. You can load your own image (*.bmp) and audio (*.wav) files providing that the file formats are supported by the demonstration. For more details please refer to [Section 2.4.5: Audio player](#) and [Section 2.4.6: Image browser](#). The default audio file available in the USB Flash disk is based on a free music download from the DanoSongs.com website.

This demonstration firmware is available for download from the STMicroelectronics website: <http://www.st.com>.

Figure 1. STM3210C-EVAL board with touch screen navigation



Contents

- 1 Glossary 5**

- 2 Demonstration architecture overview 6**
 - 2.1 Hardware resources 6
 - 2.2 Hardware configuration 7
 - 2.2.1 Required accessories 7
 - 2.2.2 Jumper settings 7
 - 2.3 Software resources 8
 - 2.4 Demo description 9
 - 2.4.1 Navigation procedure 9
 - 2.4.2 Demo startup 9
 - 2.4.3 USB console 10
 - 2.4.4 System info 11
 - 2.4.5 Audio player 13
 - 2.4.6 Image browser 14
 - 2.4.7 Board game 15
 - 2.4.8 Web server 15
 - 2.4.9 Clock security system 17
 - 2.4.10 Power saving mode 17
 - 2.4.11 Sub-demo interaction 17
 - 2.5 STM3210C-EVAL demonstration package 18
 - 2.5.1 USB Flash disk directory organization 19

- 3 Revision history 20**

List of tables

Table 1.	Acronyms and definitions	5
Table 2.	STM3210C-EVAL jumpers	7
Table 3.	BMP formats supported	14
Table 4.	Document revision history	20

List of figures

Figure 1.	STM3210C-EVAL board with touch screen navigation.	1
Figure 2.	Hardware block diagram.	6
Figure 3.	STM3210C-EVAL hardware.	7
Figure 4.	Software architecture	8
Figure 5.	STM3210C-EVAL board with touch screen navigation.	9
Figure 6.	Startup messages.	9
Figure 7.	Main desktop	10
Figure 8.	USB console display.	10
Figure 9.	System info page 1: Hardware information.	11
Figure 10.	System info page 2: CPU information.	11
Figure 11.	System info page 3: Task Information	12
Figure 12.	System info page 4: Miscellaneous Information	12
Figure 13.	Audio player controls	13
Figure 14.	Image browser example	14
Figure 15.	Game display	15
Figure 16.	Web server display	15
Figure 17.	Package directory tree	18
Figure 18.	USB Flash disk directory tree	19

1 Glossary

Table 1. Acronyms and definitions

GUI	Graphical user interface
USB	Universal serial bus
OTG	USB on-the-go
RTOS	Real-time operating system

2 Demonstration architecture overview

2.1 Hardware resources

The demonstration firmware mainly uses the following two major peripherals which are major features of the STM32 Connectivity Line:

- Ethernet
- USB on-the-go

The firmware makes use of other STM32 peripherals for demonstration purposes:

- User interface: color display, LEDs, event input (keys, touch screen)
- Media storage
- Audio (wav) player

Some other STM32 hardware features are used globally by the demonstration application and the software environment (for example the SysTick timer for RTOS).

Figure 2. Hardware block diagram

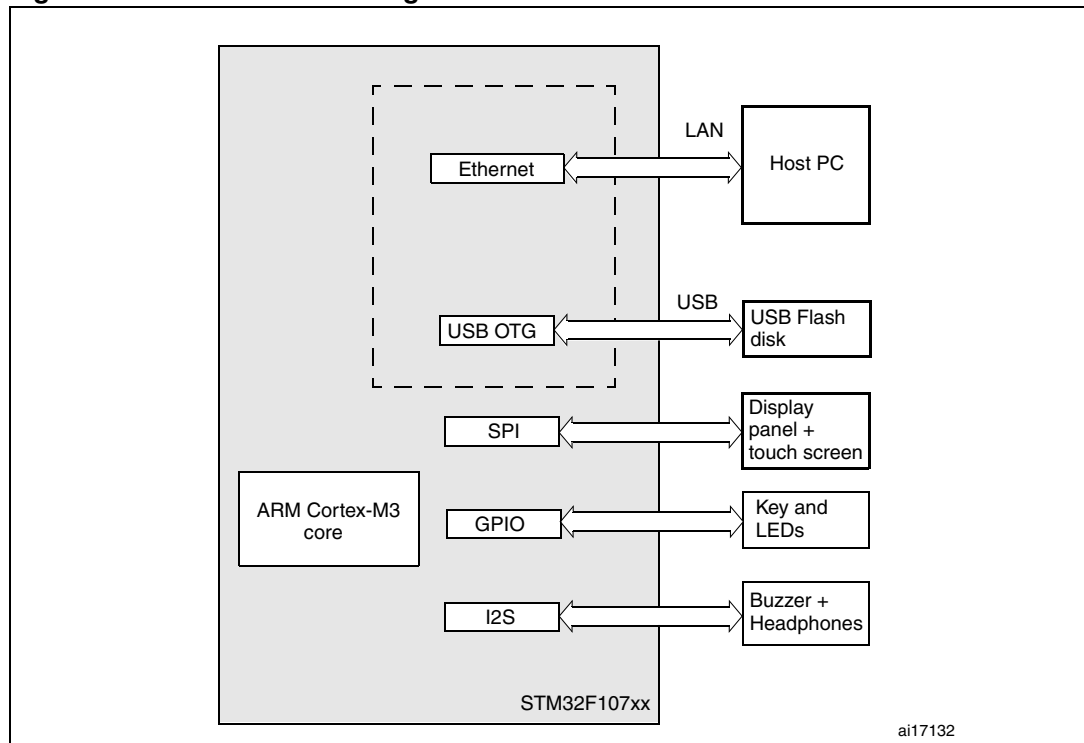

2.2 Hardware configuration

Figure 3. STM3210C-EVAL hardware

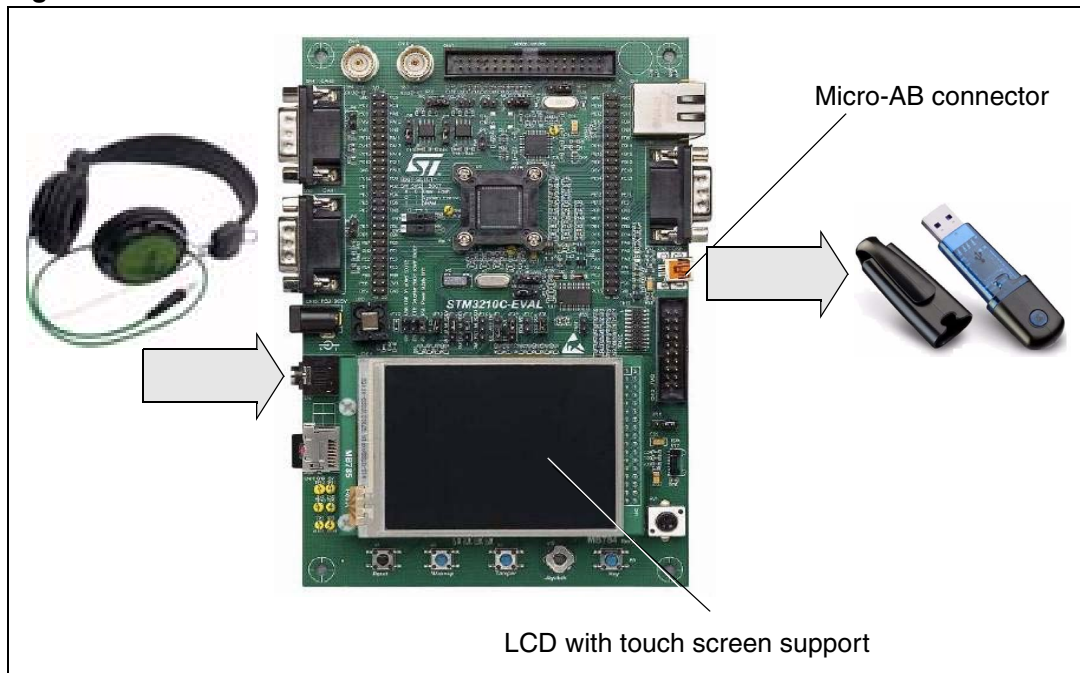

2.2.1 Required accessories

In addition to the STM3210C-EVAL board, the demonstration requires the following accessories:

- USB Flash disk (provided with STM3210C-EVAL board package)
- Headphone with male jack connector
- Micro-AB to standard receptacle A connector (provided with STM3210C-EVAL board package)

2.2.2 Jumper settings

The following jumpers on the STM3210C-EVAL board should be configured shown in [Table 2](#):

Table 2. STM3210C-EVAL jumpers

Jumper	Usage	Configuration
JP2	Ethernet	Not fitted
JP3	Ethernet	2<->3 (MII)
JP4	Ethernet	2<->3 (MCO)
JP11-12-13	Ethernet	2<->3
JP14	Ethernet	1<->2
JP24	VBAT (RTC)	1<->2
JP10	I2S	1<->2

Table 2. STM3210C-EVAL jumpers (continued)

Jumper	Usage	Configuration
JP17	I2C	Fitted
SW1	Boot	1<->2
SW2	Boot	1<->2

2.3 Software resources

The demonstration is built with a modular architecture based on a real time operating system and uses a graphical windowing system based on the uC-OS-II RTOS from Micrium and the emWin graphical stack from Segger.

The system configuration and the standard peripheral settings and configuration are made through the STM32F10x Standard Peripheral Library.

Data used by the application are stored in the external USB Flash disk through a FAT file system (emFile from Segger) in order to save space in the STM32 internal Flash memory.

Figure 4. Software architecture

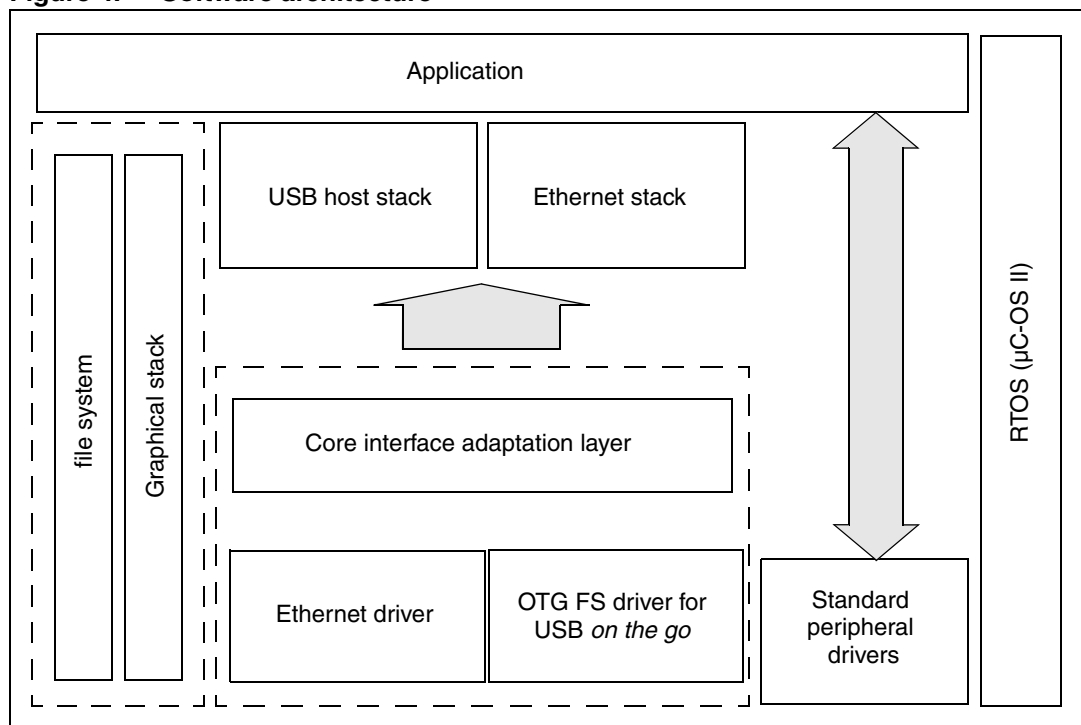

The demonstration application is built using the following software components:

1. STM32F10x Standard Peripheral Library V3.1.0
2. µC-OSII RTOS v 2.86
3. µC-USB Host stack v3.0
4. Graphical stack emWin V3.10.
5. File System emFile V4.16 from Segger
6. uIP TCP/IP stack v0.9

2.4 Demo description

The STM3210C-EVAL demonstration is composed of five sub-demos and uses the eWIN graphical stack, uC-Host stack, the embedded touch screen is used as input device (one touch mode) and the LCD is used in 16-bit color mode.

2.4.1 Navigation procedure

The STM3210C-EVAL demonstration is an interactive application; the navigation within sub-demos is done by a single touch using a pen or by finger on the active touch screen.

Figure 5. STM3210C-EVAL board with touch screen navigation



2.4.2 Demo startup

The application starts in text mode till the initialization phase is completed.

Figure 6. Startup messages

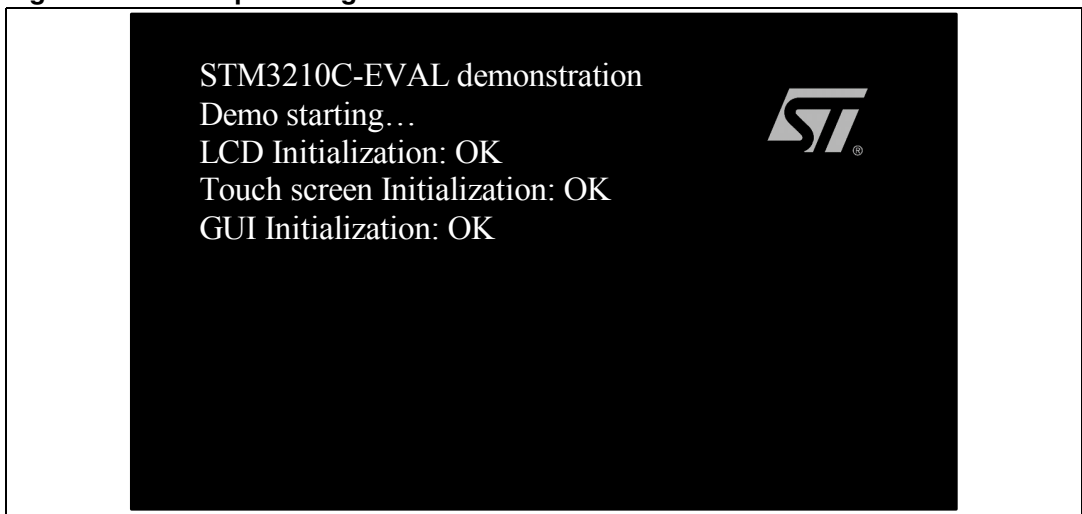

After initializing the hardware, the USB host and the GUI stacks, the main desktop appears.

Figure 7. Main desktop

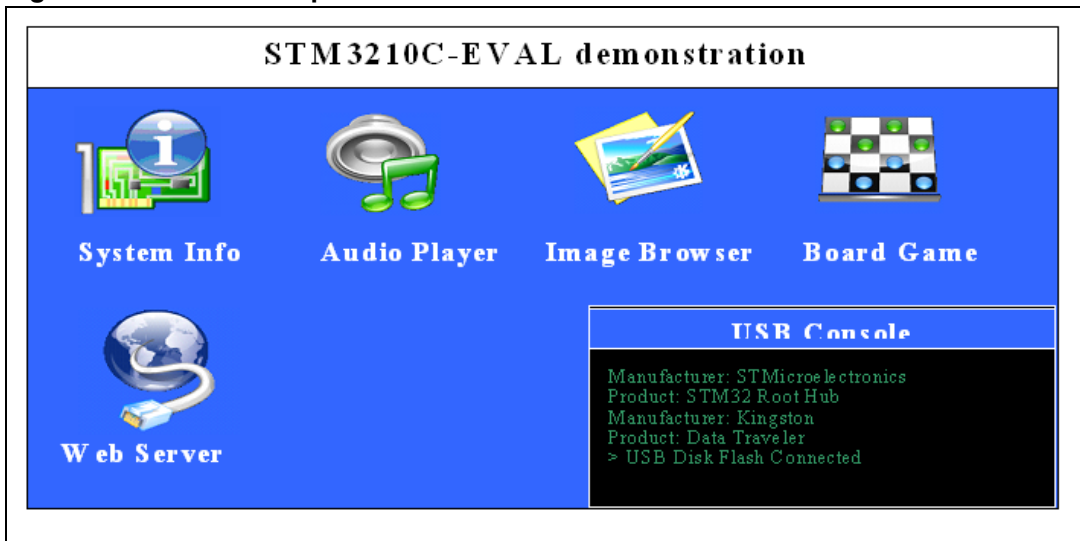

2.4.3 USB console

Figure 8. USB console display

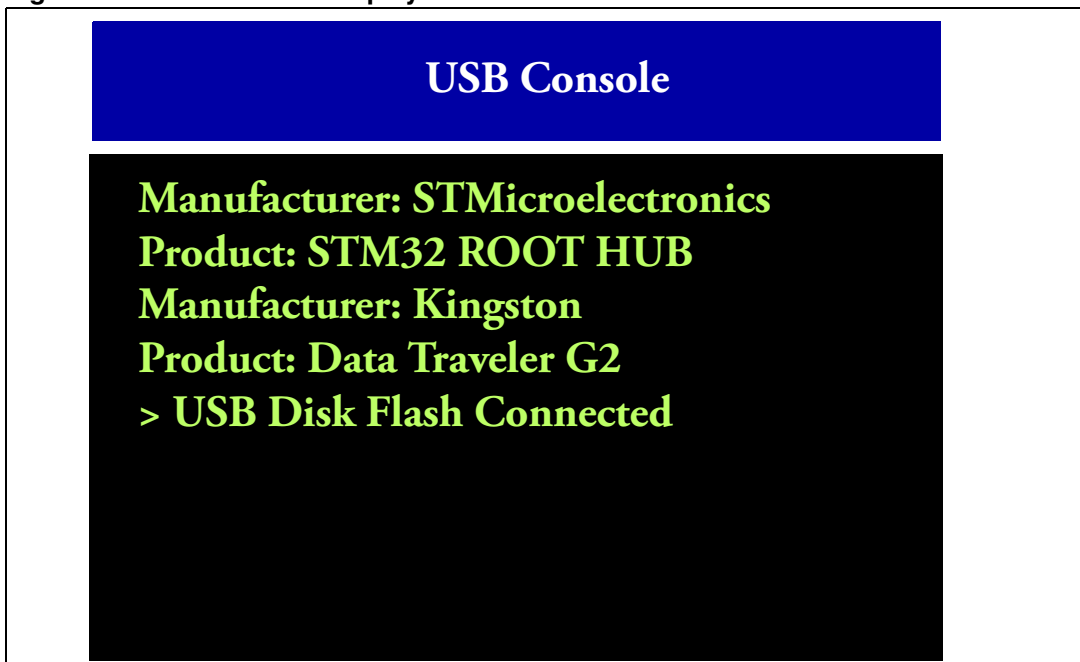

The USB console frame is always displayed to show the USB connectivity state: the message **USB Disk Flash Connected** means that the USB Flash disk is configured and ready to be used.

2.4.4 System info

Figure 9. System info page 1: Hardware information

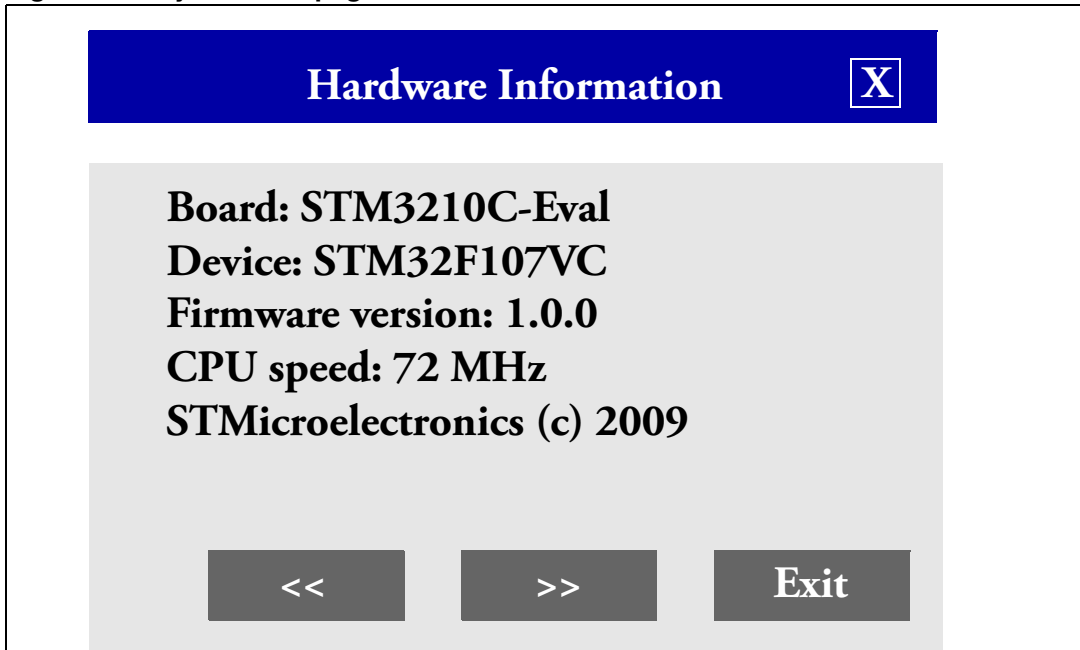

Figure 10. System info page 2: CPU information

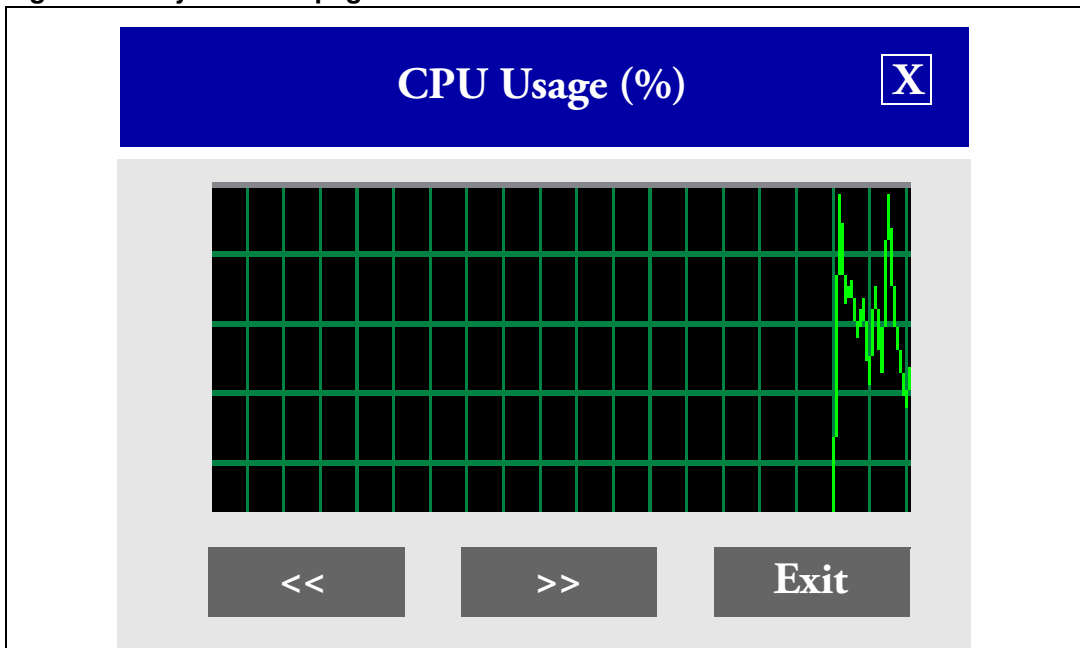

Figure 11. System info page 3: Task Information

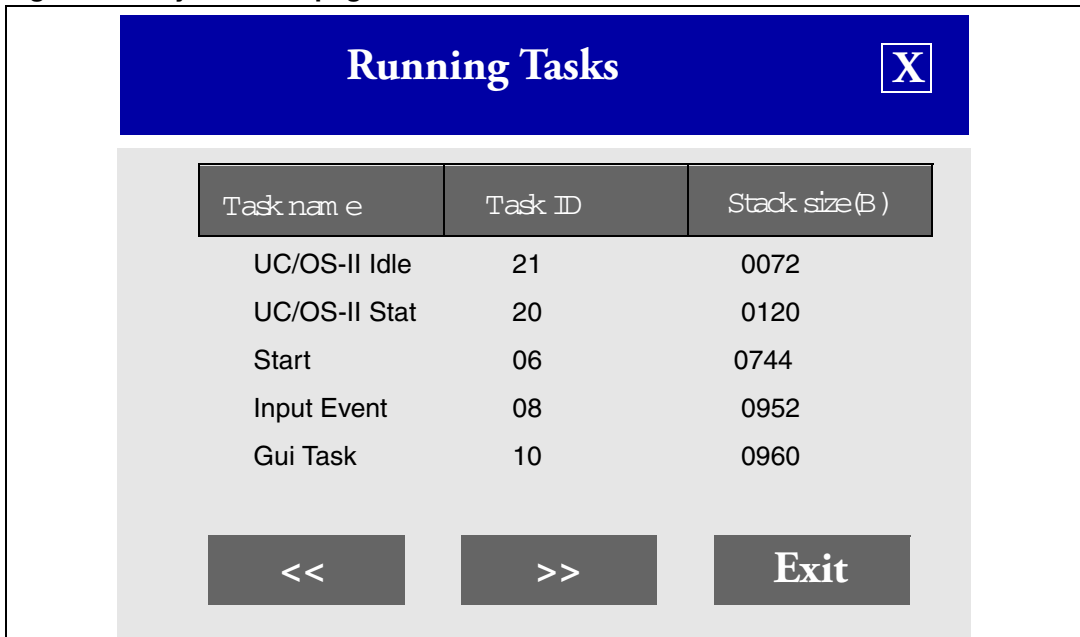
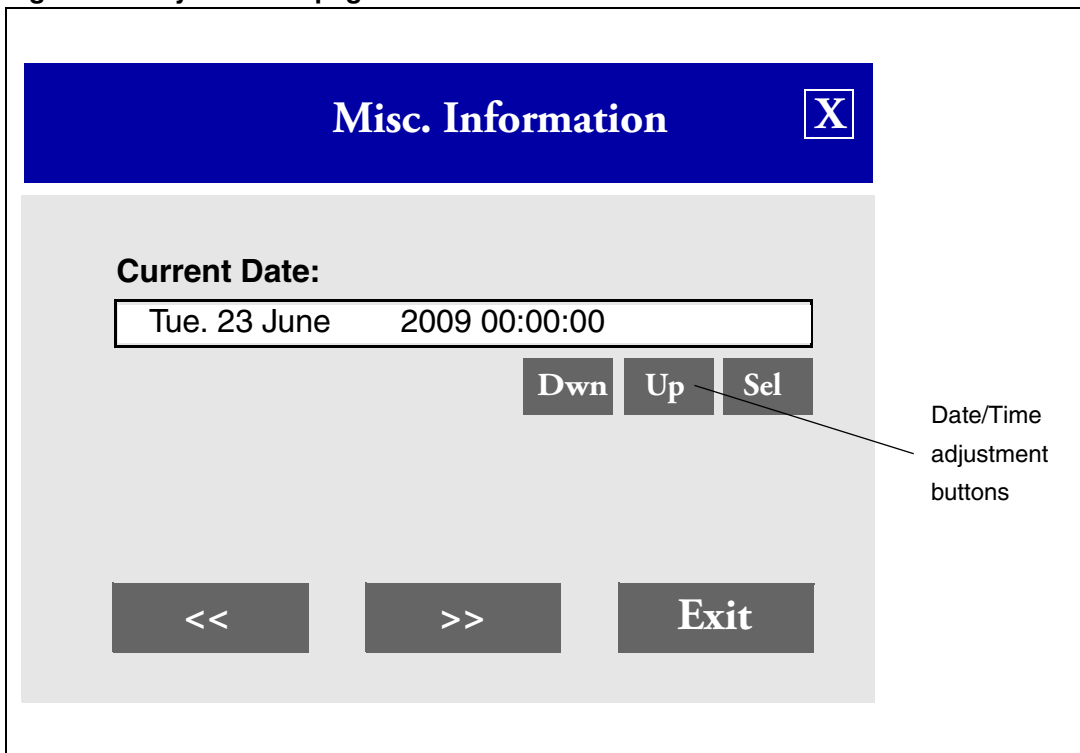

Figure 12. System info page 4: Miscellaneous Information



2.4.5 Audio player

The audio player retrieves the wav files stored in the “Audio” directory in the connected USB Flash disk and plays them in a loop. The user can stop/play/resume/Go back/ forward and mute the audio sample.

Note: The USB Flash disk should not be disconnected while the audio player application is running.

Figure 13. Audio player controls

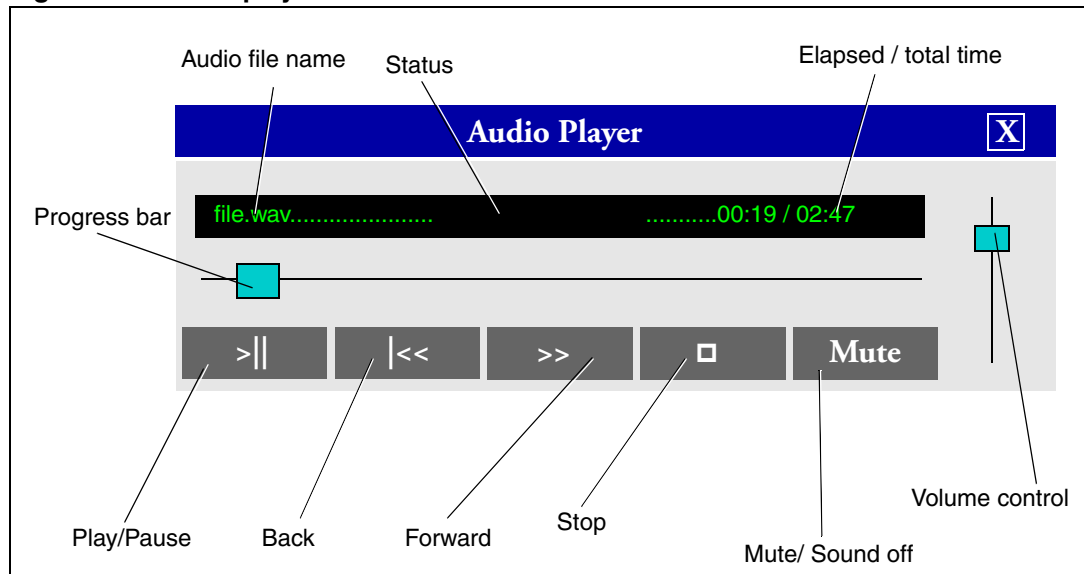

The Audio player supports all wav PCM audio files with the following configuration:

- Data length 8/16 bits
- Audio frequency: 8 to 96 kHz
- Channel number: Stereo/Mono

2.4.6 Image browser

The Image browser retrieves the bitmap (BMP) files stored in the “Images” directory from the connected USB Flash disk and displays them. The Images browser automatically resizes the image to fit in the display area.

Note: The USB Flash disk should not be disconnected while the Image browser application is running.

Figure 14. Image browser example

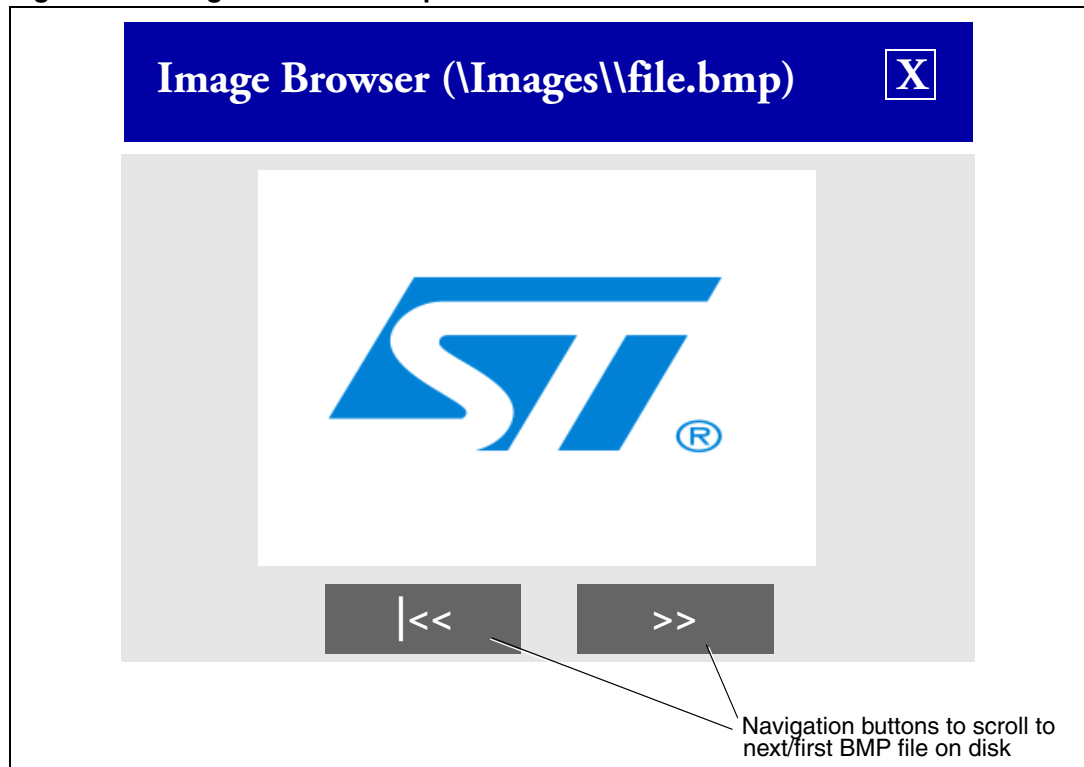

The Image browser supports BMP file with formats as listed in [Table 3](#).

Table 3. BMP formats supported

bits per pixel	Indexed	Compression	Supported
1	yes	no	yes
4	yes	no	yes
4	yes	yes	yes
8	yes	no	yes
8	yes	yes	yes
16	no	no	yes
24	no	no	yes
32	no	no	yes

2.4.7 Board game

The available game is a light version of the well-known Reversi game.

Figure 15. Game display

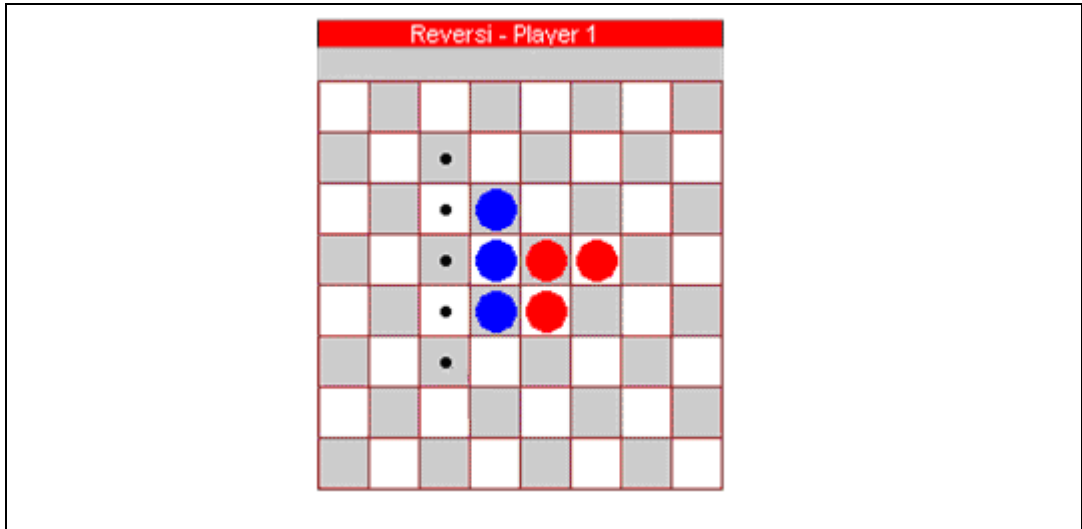

2.4.8 Web server

Figure 16. Web server display

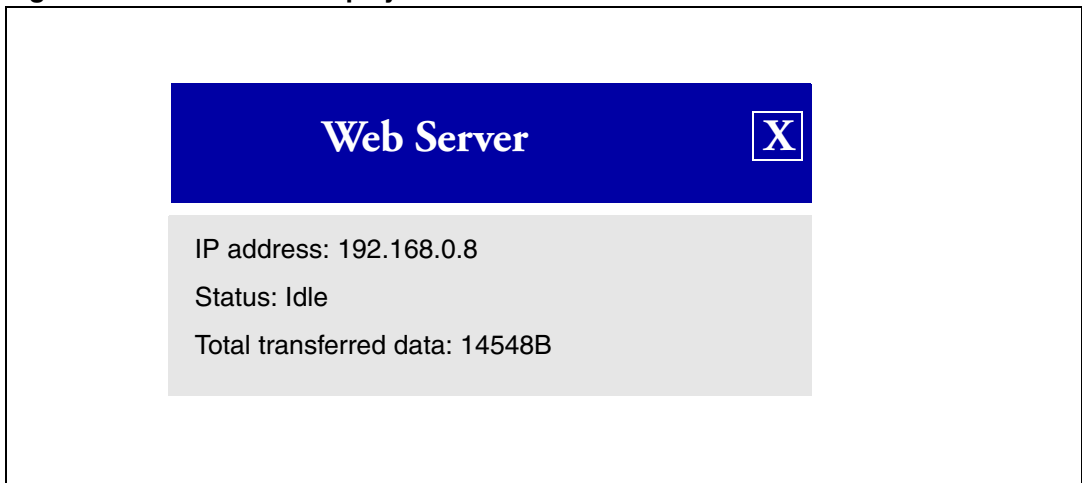

This demonstration is an embedded Webserver based on uIP TCP/IP stack v0.9. It allows you to address the STM3210C-EVAL board as a web page using your web browser to control the four LEDs on the board.

The STM32 Ethernet peripheral is configured in MII mode at 100 Mbps full duplex and the clock for the external PHY is provided by the STM32 through the MCO pin.

How to use this demonstration:

- Check that the jumper configuration on your STM3210C-EVAL board is correct, refer to [Table 2.: STM3210C-EVAL jumpers](#)
- Modify your PC network configuration
 - Disable the Internet firewall installed on your PC (if it is enabled) and bypass/deselect any proxy server in use.
 - Set your PC network card “Speed & Duplex” “to Auto Detect”, under Windows, select: Control Panel->Network Connections->Local Area Connection -> Properties->Configure->Advanced->Speed & Duplex
 - Change your PC IP address to 192.168.0.x (x different from 8): under Windows, select: Control Panel->Network Connections->Local Area Connection -> Properties->Internet Protocol (TCP/IP)->Properties->Use the following IP address
- Connect your PC to the STM3210C-EVAL board using an Ethernet crossover cable.
- Ping the board, by typing in the DOS command window: “ping 192.168.0.8”
- In your internet browser, type “http://192.168.0.8” to load the STM32 web page
- Now you can turn on/off the four LEDs on the STM3210C-EVAL board

2.4.9 Clock security system

At any demo level, if HSE clock fails (external 25 MHz crystal is broken or disconnected), a message is displayed to inform the user and the MCU enters Standby mode. To restart the demo, make sure that the external crystal is connected and then reset the board.

2.4.10 Power saving mode

If the touch screen is not activated for a period of 30 s, the MCU enters the Stop mode and the LEDs stops blinking. To return to the run mode, press the key push-button and wait a few seconds for the end of the USB enumeration.

2.4.11 Sub-demo interaction

Due to the intensive CPU use of some parts of the application, (GUI refresh and access to the USB Flash disk), some sub-demos cannot be run at same time.

In order to reduce this interaction and reduce the time needed by the GUI to refresh the displayed windows, only the USB windows are allowed to run when the "Audio Player" is running this is classed as "exclusive" sub-demo, which means that the user cannot run the "Audio Player" and another sub-demo at same time.

When the user attempts to launch an exclusive sub-demo, a message box is displayed to inform the user that an exclusive sub-demo is already running.

2.5 STM3210C-EVAL demonstration package

The STM3210C-EVAL demonstration is supplied in one single zip file. The extraction of the zip file generates one folder, **STM3210C-EVAL_FW**, which contains the subfolders shown in [Figure 17](#) and described below.

Figure 17. Package directory tree

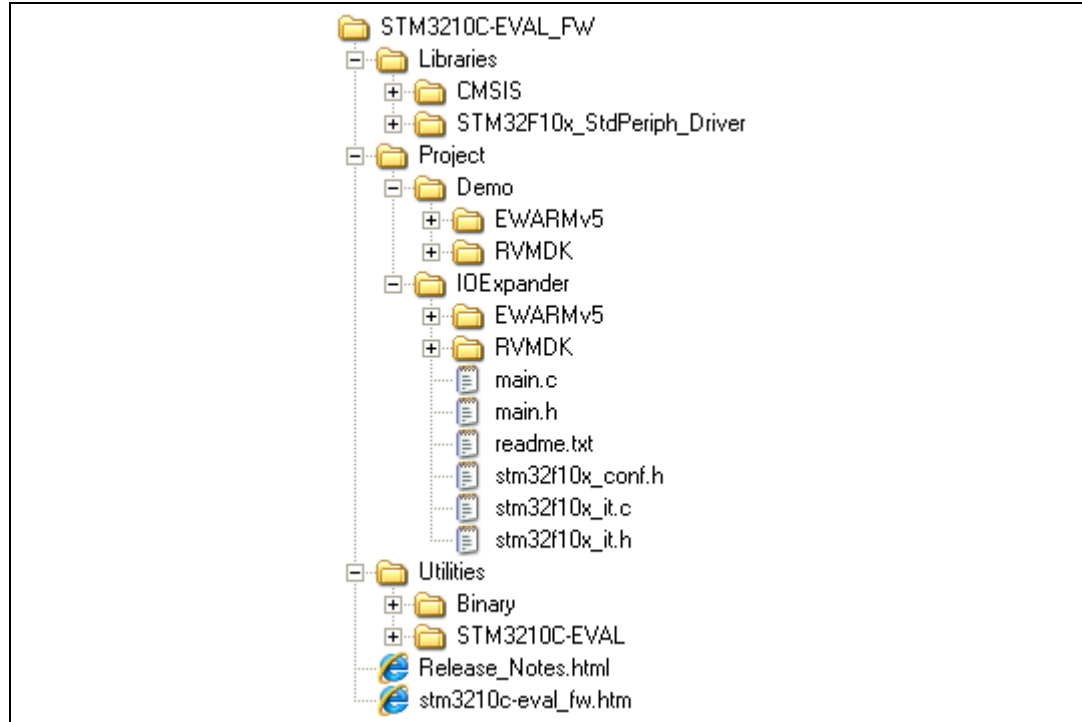

- **Libraries:** contains STM32F10xxx’s standard peripheral drivers (used for the IOExpander example)
- **Project**
 - **Demo:** contains the binary image of the demonstration plus preconfigured projects for the EWARM and RVMDK toolchains, that can be used to program the binary image to the internal Flash memory.
 - **IOExpander:** contains example projects for the EWARM and RVMDK toolchains, that demonstrate how to configure and use the IO Expander and related modules (Joystick, Touch Screen for LCD, etc.) mounted on STM3210C-EVAL.
- **Utilities**
 - **Binary:** contains binary images of the demonstration to be used with the EWARM and RVMDK toolchains (provided as backup).
 - **STM3210C-EVAL:** contains the LCD, IO Expander and other STM3210C-EVAL board-related drivers.

To program the demonstration's binary image into the internal Flash memory, you have to proceed as follows:

- EWARMv5
 - Open the *Flash_Loader.eww* project
 - Load the project image: Project->Download and Debug (CTRL+ D)
 - Restart the evaluation board (Press B1: reset button)
- RVMDK
 - Open the *Flash_Loader.uv2* project
 - Load the project image: Debug->Start/Stop Debug Session
 - Restart the evaluation board (Press B1: reset button)

2.5.1 USB Flash disk directory organization

Figure 18. USB Flash disk directory tree

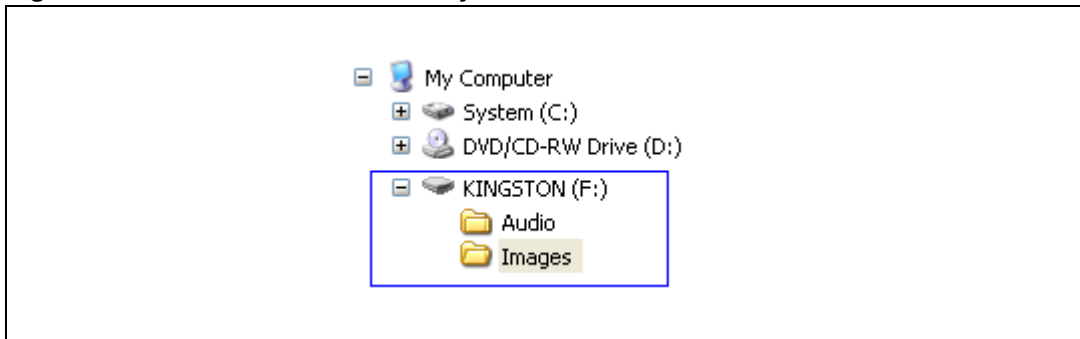

The STM3210C-EVAL board comes with a USB Flash disk preprogrammed with Audio and Image resources used by the demonstration. However you can load your own image (*.bmp) and audio (*.wav) files in the "Images" and "Audio" directories, respectively, providing that these file formats are supported by the demonstration. For more details please refer to [Section 2.4.5: Audio player](#) and [Section 2.4.6: Image browser](#).

3 Revision history

Table 4. Document revision history

Date	Revision	Changes
23-Jun-2009	1	Initial release.

Please Read Carefully:

Information in this document is provided solely in connection with ST products. STMicroelectronics NV and its subsidiaries ("ST") reserve the right to make changes, corrections, modifications or improvements, to this document, and the products and services described herein at any time, without notice.

All ST products are sold pursuant to ST's terms and conditions of sale.

Purchasers are solely responsible for the choice, selection and use of the ST products and services described herein, and ST assumes no liability whatsoever relating to the choice, selection or use of the ST products and services described herein.

No license, express or implied, by estoppel or otherwise, to any intellectual property rights is granted under this document. If any part of this document refers to any third party products or services it shall not be deemed a license grant by ST for the use of such third party products or services, or any intellectual property contained therein or considered as a warranty covering the use in any manner whatsoever of such third party products or services or any intellectual property contained therein.

UNLESS OTHERWISE SET FORTH IN ST'S TERMS AND CONDITIONS OF SALE ST DISCLAIMS ANY EXPRESS OR IMPLIED WARRANTY WITH RESPECT TO THE USE AND/OR SALE OF ST PRODUCTS INCLUDING WITHOUT LIMITATION IMPLIED WARRANTIES OF MERCHANTABILITY, FITNESS FOR A PARTICULAR PURPOSE (AND THEIR EQUIVALENTS UNDER THE LAWS OF ANY JURISDICTION), OR INFRINGEMENT OF ANY PATENT, COPYRIGHT OR OTHER INTELLECTUAL PROPERTY RIGHT.

UNLESS EXPRESSLY APPROVED IN WRITING BY AN AUTHORIZED ST REPRESENTATIVE, ST PRODUCTS ARE NOT RECOMMENDED, AUTHORIZED OR WARRANTED FOR USE IN MILITARY, AIR CRAFT, SPACE, LIFE SAVING, OR LIFE SUSTAINING APPLICATIONS, NOR IN PRODUCTS OR SYSTEMS WHERE FAILURE OR MALFUNCTION MAY RESULT IN PERSONAL INJURY, DEATH, OR SEVERE PROPERTY OR ENVIRONMENTAL DAMAGE. ST PRODUCTS WHICH ARE NOT SPECIFIED AS "AUTOMOTIVE GRADE" MAY ONLY BE USED IN AUTOMOTIVE APPLICATIONS AT USER'S OWN RISK.

Resale of ST products with provisions different from the statements and/or technical features set forth in this document shall immediately void any warranty granted by ST for the ST product or service described herein and shall not create or extend in any manner whatsoever, any liability of ST.

ST and the ST logo are trademarks or registered trademarks of ST in various countries.

Information in this document supersedes and replaces all information previously supplied.

The ST logo is a registered trademark of STMicroelectronics. All other names are the property of their respective owners.

© 2009 STMicroelectronics - All rights reserved

STMicroelectronics group of companies

Australia - Belgium - Brazil - Canada - China - Czech Republic - Finland - France - Germany - Hong Kong - India - Israel - Italy - Japan - Malaysia - Malta - Morocco - Philippines - Singapore - Spain - Sweden - Switzerland - United Kingdom - United States of America

www.st.com