



ÖZDİSAN LED AYDINLATMA ÇÖZÜMLERİ

HTB04H-80~120w  
Beam angle 50°for high pole lighting



HTB04F-80~120w  
Beam angle 90°for floodlight lighting



HTB04T-80~120w  
Beam angle 130°for tunnel lighting

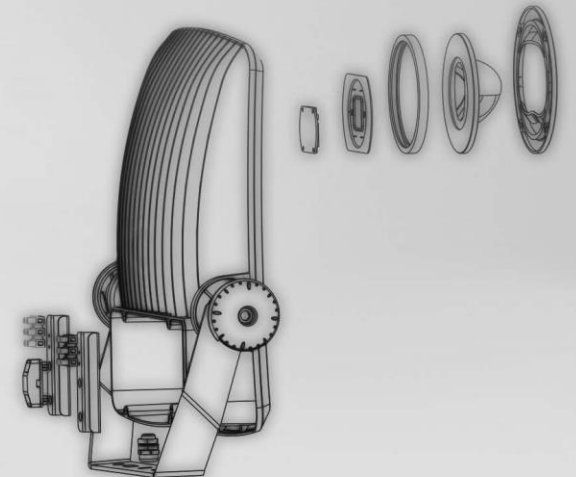
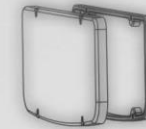
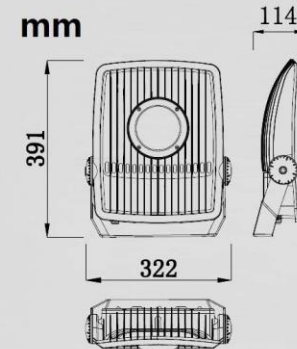

Design

LED PROJEKTÖR  
TÜNEL AYDINLATMA  
YÜKSEK TAVAN AYDINLATMA

- ✓ 50 °, 90 °, 120 °, 130 °, 140 °, patentli mercek
- ✓ IP67 koruma sınıfı
- ✓ 3 yıl garanti
- ✓ Lens ışık geçirgenliği >% 90
- ✓ 180 ° ayarlanabilir montaj konsolu
- ✓ Paslanmaz çelik vidalama seti
- ✓ Drenaj ve kendi kendini temizleme
- ✓ Yüksek termal iletken toz kaplama, korozyon direnci
- ✓ Yüksek güç entegre paketleme ışık kaynağı (COB)
- ✓ LM-80 sertifikasyon
- ✓ 100lm/W
- ✓ CE, FC, ROHS



GÜÇ	LÜMEN	AÇI	RENK	RENK GERİ VERİM	ÖMÜR	KORUMA SINIFI	GİRİŞ PF	ÇALIŞMA GERİLİM ARALIĞI	BOYUT GxDxY mm	AĞIRLIK	GARANTİ	SERTİFİKA
80W	8000lm	50/90/120/130/140	2700KELVIN 4000KELVIN 6500KELVIN	≥70	50000 Saat	IP67	0,95	90-305VAC	322x114x391	5,86 kg	3 YIL	CE FC ROHS
100W	10000lm	50/90/120/130/140	2700KELVIN 4000KELVIN 6500KELVIN	≥70	50000 Saat	IP67	0,95	90-305VAC	322x114x391	5,86 kg	3 YIL	CE FC ROHS
120W	12000lm	50/90/120/130/140	2700KELVIN 4000KELVIN 6500KELVIN	≥70	50000 Saat	IP67	0,95	90-305VAC	322x114x391	5,86 kg	3 YIL	CE FC ROHS

HTC03-30~80w  
120°/130°/140°/150° Lens



Street lamp patents NO.: ZL 2007 1 0157085.4  
ZL 2012 2 0251196.8  
ZL 2012 3 0210509.0



140° beam angle, asymmetric light distribution



130° beam angle, asymmetric light distribution



120° beam angle, asymmetric light distribution

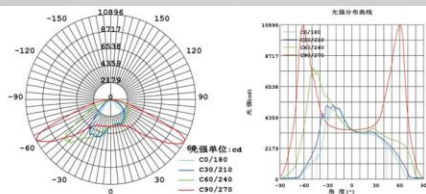

140° Light distribution curve

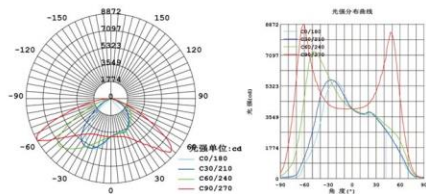

130° Light distribution curve

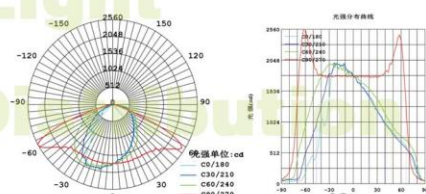

120° Light distribution curve

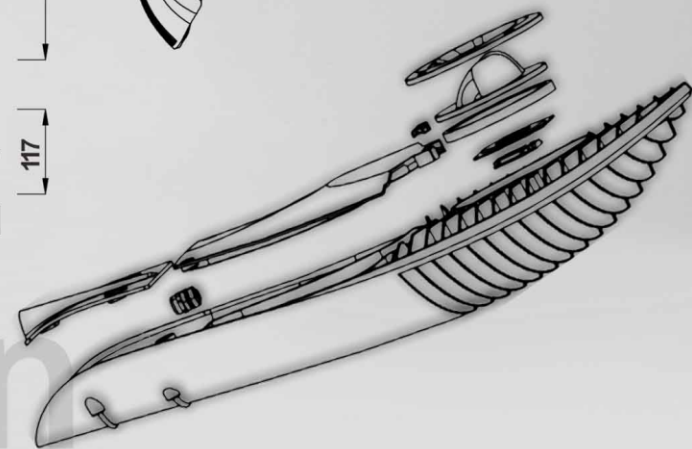
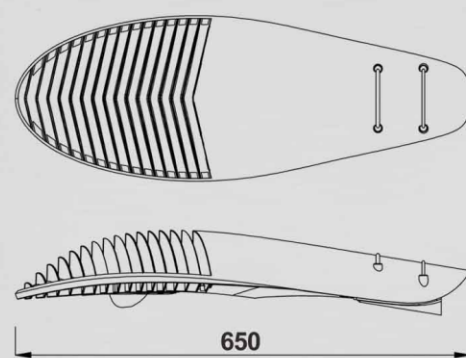

Design

## LED YOL AYDINLATMA

- ✓ 120 °, 130 °, 140 °, 150 ° patentli mercek
- ✓ IP66 koruma sınıfı
- ✓ 3 yıl garanti
- ✓ Lens ışık geçirgenliği >% 90
- ✓ Kolay montaj
- ✓ Konveksiyon tasarımı, drenaj ve kendi kendini temizleme
- ✓ Yüksek termal iletken toz kaplama, korozyon direnci
- ✓ Yüksek güç entegre paketleme ışık kaynağı (COB)
- ✓ LM-80 sertifikasyon
- ✓ 100lm/W
- ✓ Farklı renk seçenekleri
- ✓ Düşük işletme maliyeti
- ✓ Kolay led değişim imkanı (4 cıvata ile led değişimi)
- ✓ Estetik tasarım
- ✓ Hızlı ısı deplasesi
- ✓ Akıllı kontrol, fotometrik sensör, zaman ayarı, dimmer, solar opsiyonları
- ✓ SAA, TÜV, CQC, CL, CE, FC, ROHS



GÜÇ	LÜMEN	AÇI	RENK	RENK GERİ VERİM	ÖMÜR BEKLENTİSİ	KORUMA SINIFI	GİRİŞ PF	ÇALIŞMA GERİLİM ARALIĞI	BOYUT GxDxY mm	AĞIRLIK	GARANTİ	SERTİFİKA
30W	3000lm	120/130/140/150	2700KELVIN 4000KELVIN 6500KELVIN	≥70	50000 Saat	IP66	0,95	90-305VAC	236x650x117	5,4 kg	3 YIL	SAA / CE / TUV / CQC / CL / ROHS
40W	4000lm	120/130/140/150	2700KELVIN 4000KELVIN 6500KELVIN	≥70	50000 Saat	IP66	0,95	90-305VAC	236x650x117	5,4 kg	3 YIL	SAA / CE / TUV / CQC / CL / ROHS
50W	5000lm	120/130/140/150	2700KELVIN 4000KELVIN 6500KELVIN	≥70	50000 Saat	IP66	0,95	90-305VAC	236x650x117	5,4 kg	3 YIL	SAA / CE / TUV / CQC / CL / ROHS
60W	6000lm	120/130/140/150	2700KELVIN 4000KELVIN 6500KELVIN	≥70	50000 Saat	IP66	0,95	90-305VAC	236x650x117	5,4 kg	3 YIL	SAA / CE / TUV / CQC / CL / ROHS

HTC02-80~120w  
120°/130°/140°/150° Lens



Street lamp patents NO.: ZL 2007 1 0157085.4  
ZL 2012 2 0251196.8  
ZL 2012 3 0210509.0



140° beam angle, asymmetric light distribution



130° beam angle, asymmetric light distribution



120° beam angle, asymmetric light distribution

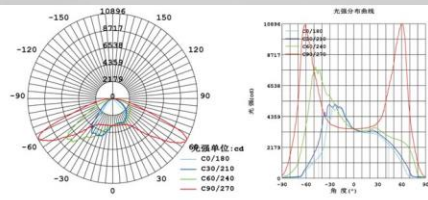

140° Light distribution curve

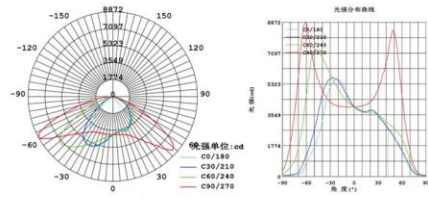

130° Light distribution curve

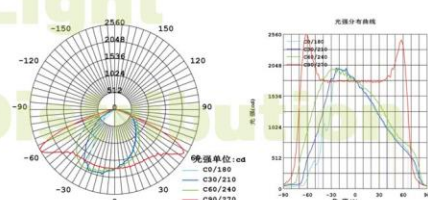

120° Light distribution curve

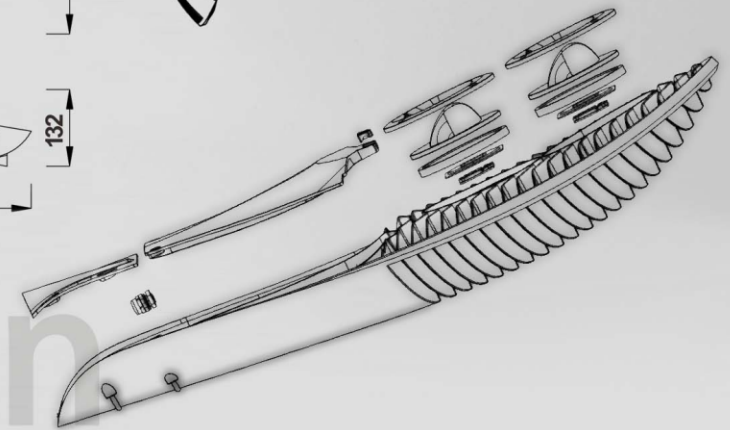
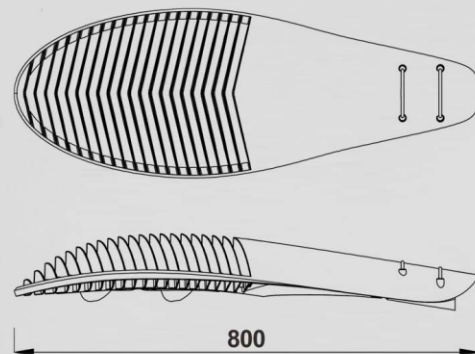

Design

## LED YOL AYDINLATMA

- ✓ 120 °, 130 °, 140 ° patentli mercek
- ✓ IP66 koruma sınıfı
- ✓ 3 yıl garanti
- ✓ Lens ışık geçirgenliği >% 90
- ✓ Kolay montaj
- ✓ Konveksiyon tasarımı, drenaj ve kendi kendini temizleme
- ✓ Yüksek termal iletken toz kaplama, korozyon direnci
- ✓ Yüksek güç entegre paketleme ışık kaynağı (COB)
- ✓ LM-80 sertifikasyon
- ✓ 100lm/W
- ✓ Farklı renk seçenekleri
- ✓ Düşük işletme maliyeti
- ✓ Kolay led değişim imkanı (4 cıvata ile led değişimi)
- ✓ Estetik tasarım
- ✓ Hızlı ısı deplasesi
- ✓ Akıllı kontrol, fotometrik sensör, zaman ayarı, dimmer, solar opsiyonları
- ✓ SAA, TÜV, CQC, CL, CE, FC, ROHS

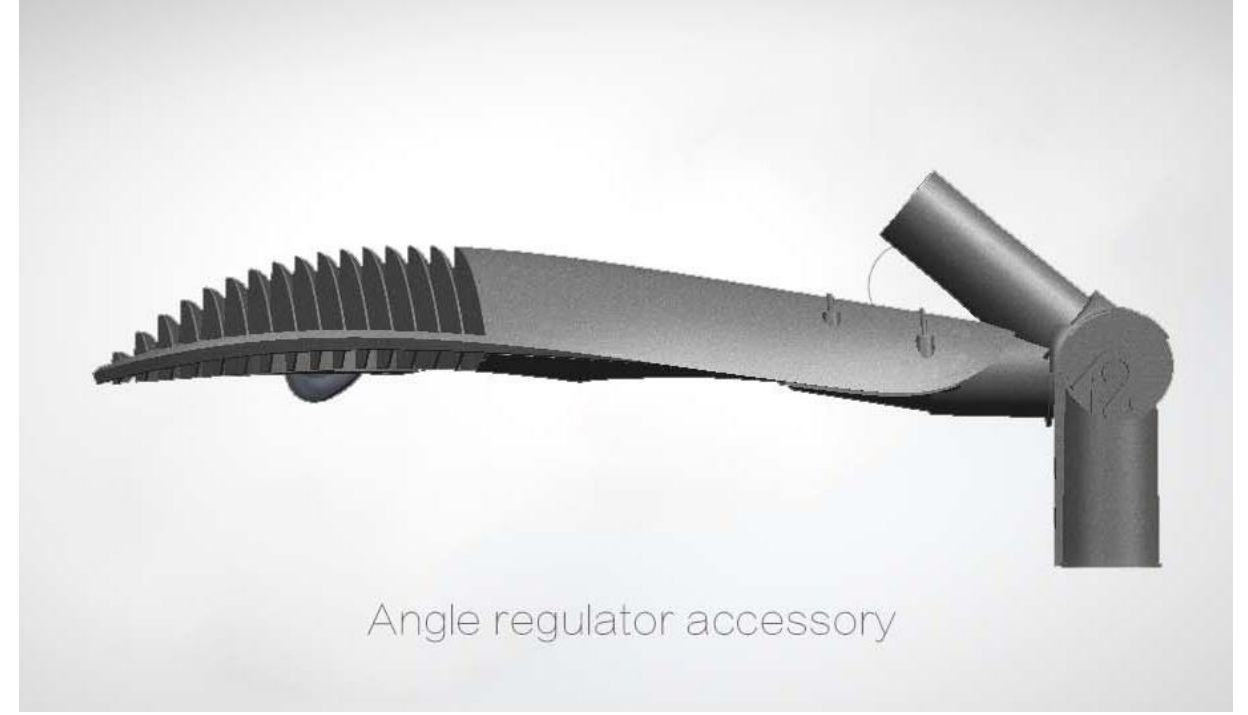

GÜÇ	LÜMEN	AÇI	RENK	RENK GERİ VERİM	ÖMÜR BEKLENTİSİ	KORUMA SINIFI	GİRİŞ PF	ÇALIŞMA GERİLİM ARALIĞI	BOYUT GxDxY mm	AĞIRLIK	GARANTİ	SERTİFİKA
80W	8000lm	120/130/140	2700KELVIN 4000KELVIN 6500KELVIN	≥70	50000 Saat	IP66	0,95	90-305VAC	291x800x132	8,1 kg	3 YIL	SAA / CE / TUV / CQC / CL / ROHS
100W	10000lm	120/130/140	2700KELVIN 4000KELVIN 6500KELVIN	≥70	50000 Saat	IP66	0,95	90-305VAC	291x800x132	8,1 kg	3 YIL	SAA / CE / TUV / CQC / CL / ROHS
120W	12000lm	120/130/140	2700KELVIN 4000KELVIN 6500KELVIN	≥70	50000 Saat	IP66	0,95	90-305VAC	291x800x132	8,1 kg	3 YIL	SAA / CE / TUV / CQC / CL / ROHS

HTC01-150~180w  
120°/130°/140°/150° Lens



Street lamp patents NO.: ZL 2007 1 0157085.4  
ZL 2012 2 0251196.8  
ZL 2012 3 0210509.0



140° beam angle, asymmetric light distribution



130° beam angle, asymmetric light distribution



120° beam angle, asymmetric light distribution

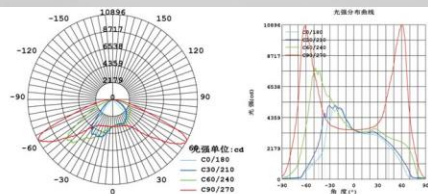

140° Light distribution curve

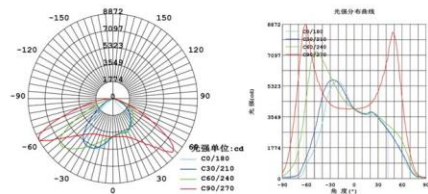

130° Light distribution curve

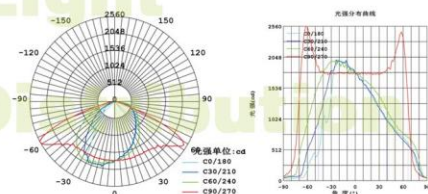

120° Light distribution curve

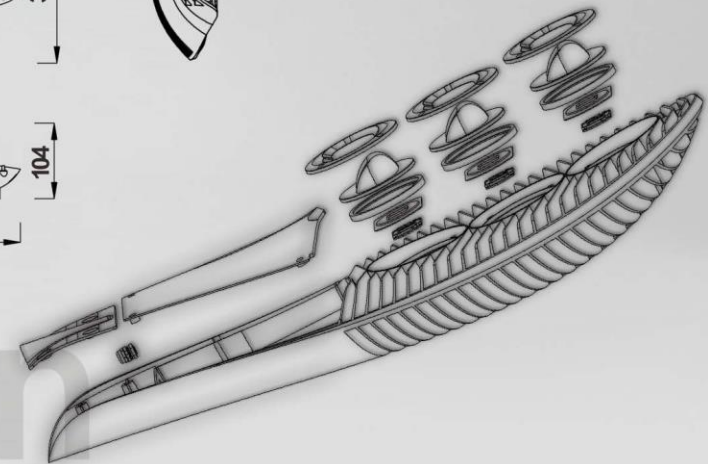
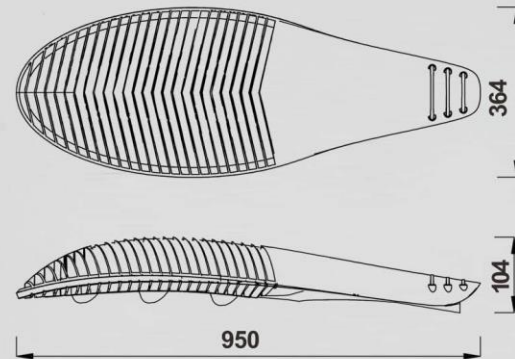

Design



## LED YOL AYDINLATMA

- ✓ 120 °, 130 °, 140 ° patentli mercek
- ✓ IP66 koruma sınıfı
- ✓ 3 yıl garanti
- ✓ Lens ışık geçirgenliği >% 90
- ✓ Kolay montaj
- ✓ Konveksiyon tasarımı, drenaj ve kendi kendini temizleme
- ✓ Yüksek termal iletken toz kaplama, korozyon direnci
- ✓ Yüksek güç entegre paketleme ışık kaynağı (COB)
- ✓ LM-80 sertifikasyon
- ✓ 100lm/W
- ✓ Farklı renk seçenekleri
- ✓ Düşük işletme maliyeti
- ✓ Kolay led değişim imkanı (4 cıvata ile led değişimi)
- ✓ Estetik tasarım
- ✓ Hızlı ısı deplasmanı
- ✓ Akıllı kontrol, fotometrik sensör, zaman ayarı, dimmer, solar opsiyonları
- ✓ SAA, TÜV, CQC, CL, CE, FC, ROHS



GÜÇ	LÜMEN	AÇI	RENK	RENK GERİ VERİM	ÖMÜR BEKLENTİSİ	KORUMA SINIFI	GİRİŞ PF	ÇALIŞMA GERİLİM ARALIĞI	BOYUT GxDxY mm	AĞIRLIK	GARANTİ	SERTİFİKA
150W	15000lm	120/130/140	2700KELVIN 4000KELVIN 6500KELVIN	≥70	50000 Saat	IP66	0,95	90-305VAC	364x950x104	13,4 kg	3 YIL	SAA / CE / TUV / CQC / CL / ROHS
180W	18000lm	120/130/140	2700KELVIN 4000KELVIN 6500KELVIN	≥70	50000 Saat	IP66	0,95	90-305VAC	364x950x104	13,4 kg	3 YIL	SAA / CE / TUV / CQC / CL / ROHS



**Özdisan Elektronik Paz. San.Tic. A.Ş.**

1201/2 Sokak No:2B Temsil Plaza İş Merkezi Yenişehir İZMİR

Telefon 0232 459 51 50 (Pbx) Faks 0232 469 78 00

E-posta [izmir@ozdisan.com](mailto:izmir@ozdisan.com) Web [www.ozdisan.com](http://www.ozdisan.com)