

Achieving the best system cost in Mid/High Power

Mid-Power LED – 3020 Series

STW8B12B (Cool, Neutral, Warm)



Product Brief

Description

- This White Colored surface-mount LED comes in standard package dimension. Package Size : 3.0x2.0x0.6mm
- It has a substrate made up of a molded plastic reflector sitting on top of a lead frame.
- The die is attached within the reflector cavity and the cavity is encapsulated by silicone.
- The package design coupled with careful selection of component materials allow these products to perform with high reliability.

Features and Benefits

- Thermally Enhanced Package Design
- Mid Power (up to 0.26W)
- Max. Driving Current 80mA
- Compact Package Size
- High Color Quality with CRI Min. 80(R9>0)
- RoHS compliant

Key Applications

- Interior lighting
- General lighting
- Indoor and Outdoor displays
- Architectural and Decorative lighting

Table 1. Product Selection Table

| Part Number | CCT | | | |
|-------------|---------------|-------|-------|-------|
| | Color | Min. | Typ. | Max. |
| STW8B12B | Cool White | 4700K | 5600K | 7000K |
| STW8B12B | Neutral White | 3700K | 4200K | 4700K |
| STW8B12B | Warm White | 2600K | 3000K | 3700K |

Table of Contents

Index

- Product Brief
 - Table of Contents
 - Performance Characteristics
 - Color Bin Structure
 - Packaging Information
 - Product Nomenclature (Labeling Information)
 - Recommended Solder Pad
 - Reflow Soldering Characteristics
 - Handling of Silicone Resin for LEDs
 - Precaution For Use
 - Company Information
-

Performance Characteristics

Table 2. Product Selection Guide, $I_F=40\text{mA}$, $T_a=25^\circ\text{C}$, RH30%

| Part Number | CCT (K) ^[1] | RANK | Luminous Intensity ^[2] I_V (cd) | | Luminous Flux ^[3] Φ_V (lm) | | CRI R_a |
|-------------|------------------------|------|---|------|---|------|--------------|
| | Typ. | | Min | Max | Min | Max | Min. |
| STW8B12B | 6500 | M0 | 4.0 | 4.5 | 12.0 | 13.5 | 80 |
| | | M5 | 4.5 | 5.0 | 13.5 | 15 | 80 |
| | | N0 | 5.0 | 5.5 | 15 | 16.5 | 80 |
| | | N5 | 5.5 | 6.0 | 16.5 | 18 | 80 |
| | 5600 | M0 | 4.0 | 4.5 | 12.0 | 13.5 | 80 |
| | | M5 | 4.5 | 5.0 | 13.5 | 15 | 80 |
| | | N0 | 5.0 | 5.5 | 15 | 16.5 | 80 |
| | | N5 | 5.5 | 6.0 | 16.5 | 18 | 80 |
| | 5000 | M0 | 4.0 | 4.5 | 12.0 | 13.5 | 80 |
| | | M5 | 4.5 | 5.0 | 13.5 | 15 | 80 |
| | | N0 | 5.0 | 5.5 | 15 | 16.5 | 80 |
| | | N5 | 5.5 | 6.0 | 16.5 | 18 | 80 |
| | 4500 | M0 | 4.0 | 4.5 | 12.0 | 13.5 | 80 |
| | | M5 | 4.5 | 5.0 | 13.5 | 15 | 80 |
| | | N0 | 5.0 | 5.5 | 15 | 16.5 | 80 |
| | | N5 | 5.5 | 6.0 | 16.5 | 18 | 80 |
| | 4000 | M0 | 4.0 | 4.5 | 12.0 | 13.5 | 80 |
| | | M5 | 4.5 | 5.0 | 13.5 | 15 | 80 |
| | | N0 | 5.0 | 5.5 | 15 | 16.5 | 80 |
| | | N5 | 5.5 | 6.0 | 16.5 | 18 | 80 |
| 3500 | M0 | 4.0 | 4.5 | 12.0 | 13.5 | 80 | |
| | M5 | 4.5 | 5.0 | 13.5 | 15 | 80 | |
| | N0 | 5.0 | 5.5 | 15 | 16.5 | 80 | |
| | N5 | 5.5 | 6.0 | 16.5 | 18 | 80 | |

Notes :

(1) Correlated Color Temperature is derived from the CIE 1931 Chromaticity diagram.

Color coordinate : ± 0.007

(2) Seoul Semiconductor maintains a tolerance of $\pm 7\%$ on Intensity and power measurements.

The luminous intensity I_V was measured at the peak of the spatial pattern which may not be aligned with the mechanical axis of the LED package.

(3) Calculated performance values are for reference only.

Performance Characteristics

Table 2. Product Selection Guide, $I_F=40\text{mA}$, $T_a=25^\circ\text{C}$, RH30%

| Part Number | CCT (K) ^[1] | RANK | Luminous Intensity ^[2] I_V (cd) | | Luminous Flux ^[3] Φ_V (lm) | | CRI R_a |
|-------------|------------------------|------|---|-----|---|------|--------------|
| | Typ. | | Min | Max | Min | Max | Min. |
| STW8B12B | 3000 | M0 | 4.0 | 4.5 | 12.0 | 13.5 | 80 |
| | | M5 | 4.5 | 5.0 | 13.5 | 15 | 80 |
| | | N0 | 5.0 | 5.5 | 15 | 16.5 | 80 |
| | | N5 | 5.5 | 6.0 | 16.5 | 18 | 80 |
| | 2700 | M0 | 4.0 | 4.5 | 12.0 | 13.5 | 80 |
| | | M5 | 4.5 | 5.0 | 13.5 | 15 | 80 |
| | | N0 | 5.0 | 5.5 | 15 | 16.5 | 80 |
| | | N5 | 5.5 | 6.0 | 16.5 | 18 | 80 |

Notes :

(1) Correlated Color Temperature is derived from the CIE 1931 Chromaticity diagram.

Color coordinate : ± 0.007

(2) Seoul Semiconductor maintains a tolerance of $\pm 7\%$ on Intensity and power measurements.

The luminous intensity I_V was measured at the peak of the spatial pattern which may not be aligned with the mechanical axis of the LED package.

(3) Calculated performance values are for reference only.

Performance Characteristics

Table 3. Characteristics, $I_F=40\text{mA}$, $T_a=25^\circ\text{C}$, RH30%

| Parameter | Symbol | Value | | | Unit |
|--|--------------------|-------|----------------|-------|---------------------------|
| | | Min. | Typ. | Max. | |
| Forward Current | I_F | - | 40 | 80 | mA |
| Forward Voltage | $V_F(40\text{mA})$ | 2.8 | | 3.3 | V |
| Luminous Intensity (3,700~7,000 K) | $I_v(40\text{mA})$ | - | 5.05 (15.1) | - | cd (lm) |
| Luminous Intensity (2,600~3,700 K) | $I_v(40\text{mA})$ | - | 4.50 (13.5) | - | cd (lm) |
| Color Rendering Index ^[1] | Ra | 80 | - | 90 | - |
| Viewing Angle ^[2] | $2\theta_{1/2}$ | | 120 | | |
| Power Dissipation | P_d | - | 264 | | mW |
| Junction Temperature | T_j | - | - | 125 | $^\circ\text{C}$ |
| Operating Temperature | T_{opr} | - 40 | - | + 85 | $^\circ\text{C}$ |
| Storage Temperature | T_{stg} | - 40 | - | + 100 | $^\circ\text{C}$ |
| Thermal resistance (J to S) ^[3] | $R\theta_{J-S}$ | - | 25 | - | $^\circ\text{C}/\text{W}$ |
| ESD Sensitivity(HBM) ^[4] | - | - | - | 5000 | V |

Notes :

- (1) Tolerance is ± 2.0 on CRI measurements.
- (2) $2\theta_{1/2}$ is the off-axis where the luminous intensity is 1/2 of the peak intensity
- (3) Thermal resistance: $R_{\theta_{J-S}}$ (Junction to Solder)
- (4) A zener diode is included to protect the product from ESD.

- LED's properties might be different from suggested values like above and below tables if operation condition will be exceeded our parameter range. Care is to be taken that power dissipation does not exceed the absolute maximum rating of the product.
- All measurements were made under the standardized environment of Seoul Semiconductor.

Relative Spectral Distribution

Fig 1. Color Spectrum, $T_a=25^\circ\text{C}$, RH30%

$I_F=40\text{mA}$

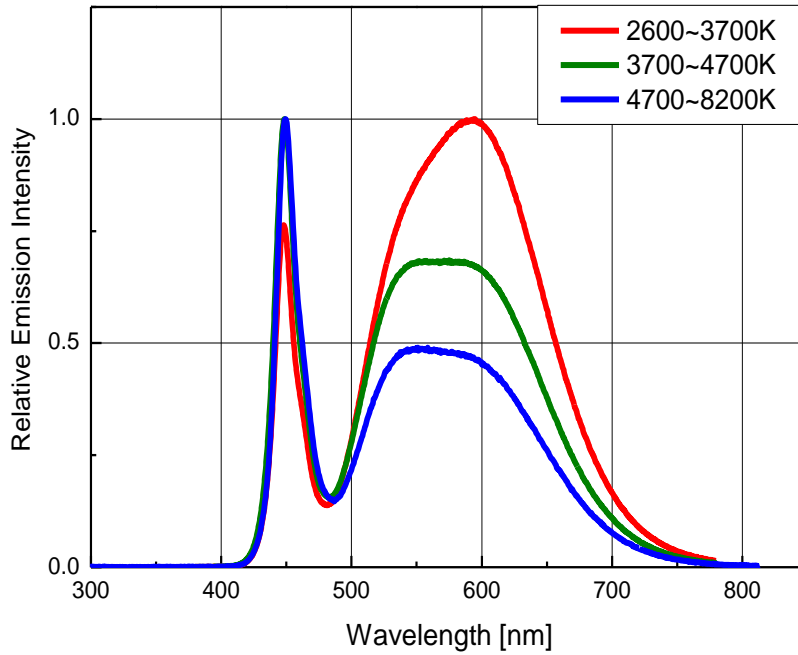
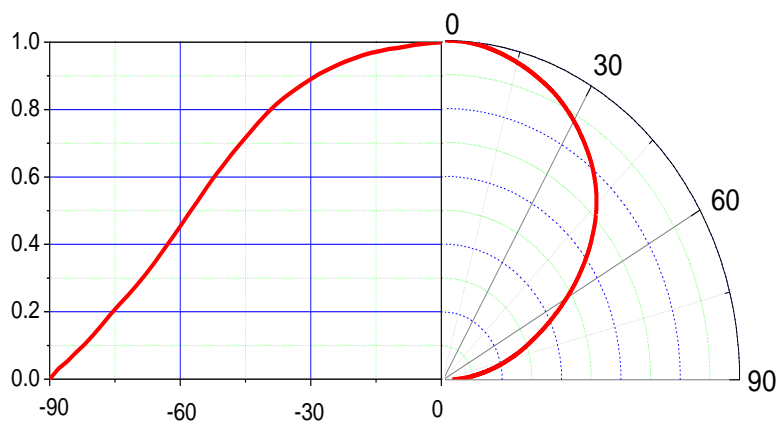

Fig 2. Viewing Angle Distribution

$I_F=40\text{mA}$



Forward Current Characteristics

Fig 3. Forward Voltage vs. Forward Current , $T_a=25^\circ\text{C}$

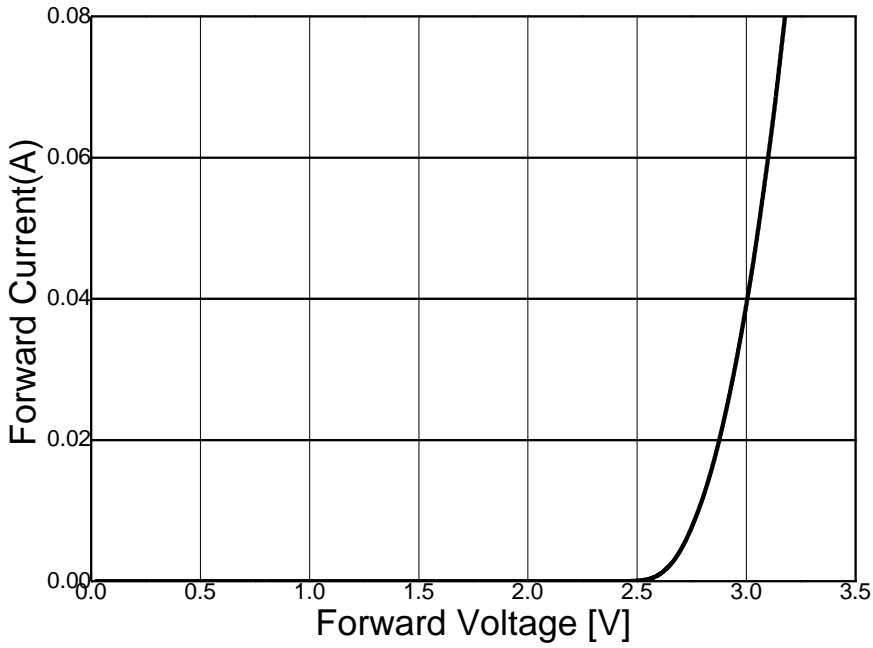
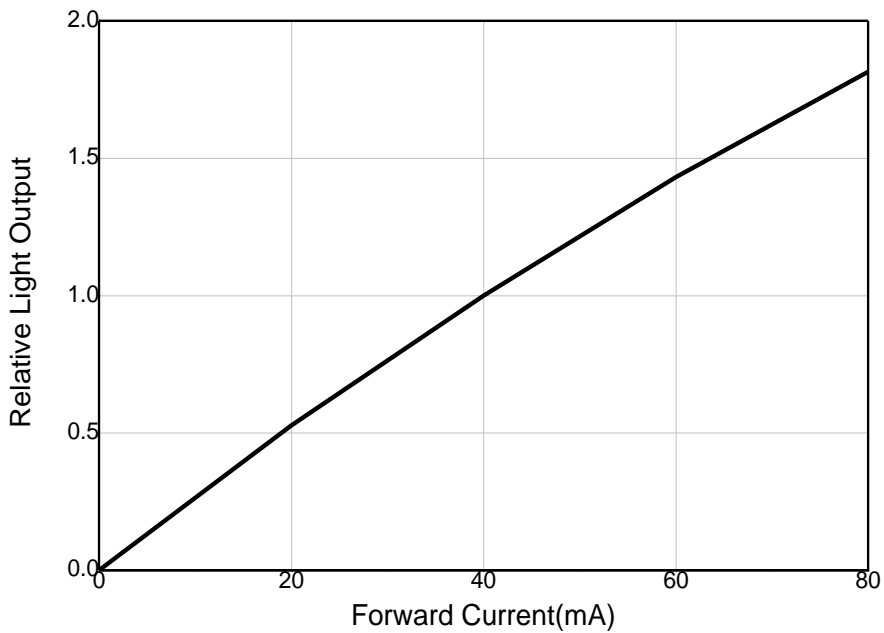
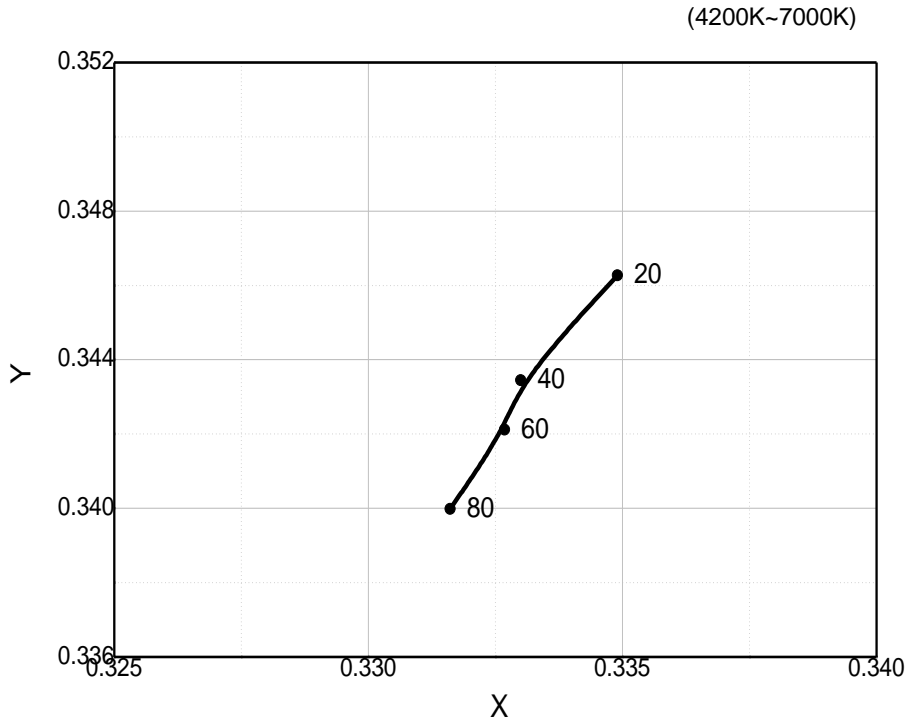

Fig 4. Forward Current vs. Relative Luminous Flux, $T_a=25^\circ\text{C}$



Forward Current Characteristics

Fig 5. Forward Current vs. CIE X, Y Shift , $T_a=25^\circ\text{C}$

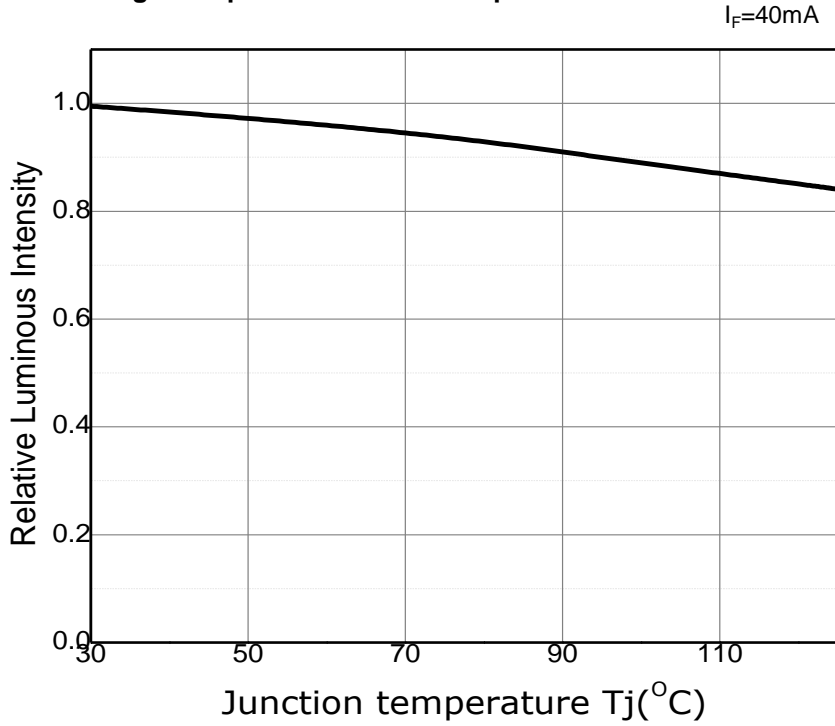
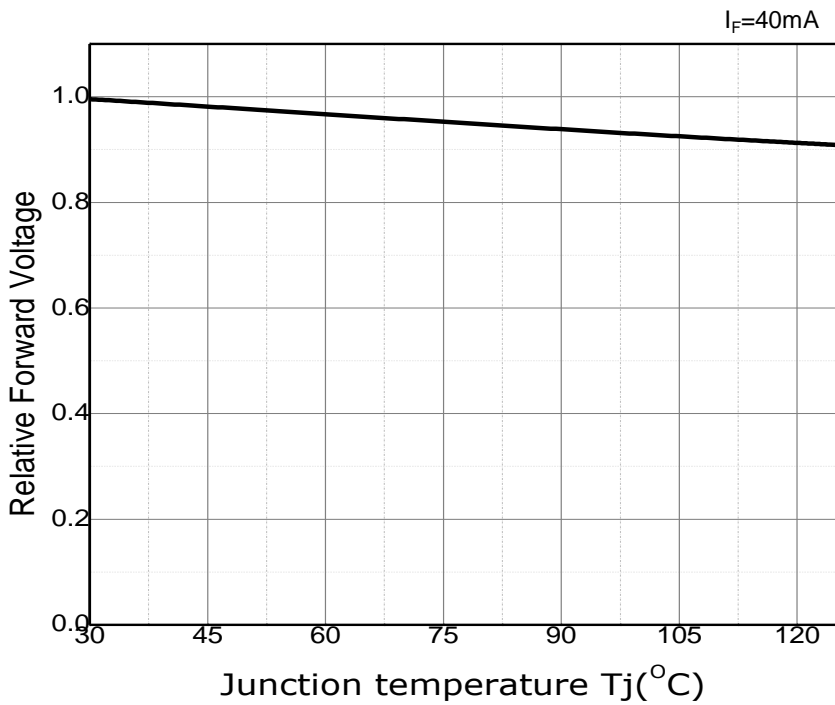

Junction Temperature Characteristics

Fig 6. Relative Light Output vs. Junction Temperature

Fig 7. Junction Temperature vs. Relative Forward Voltage

Junction Temperature Characteristics

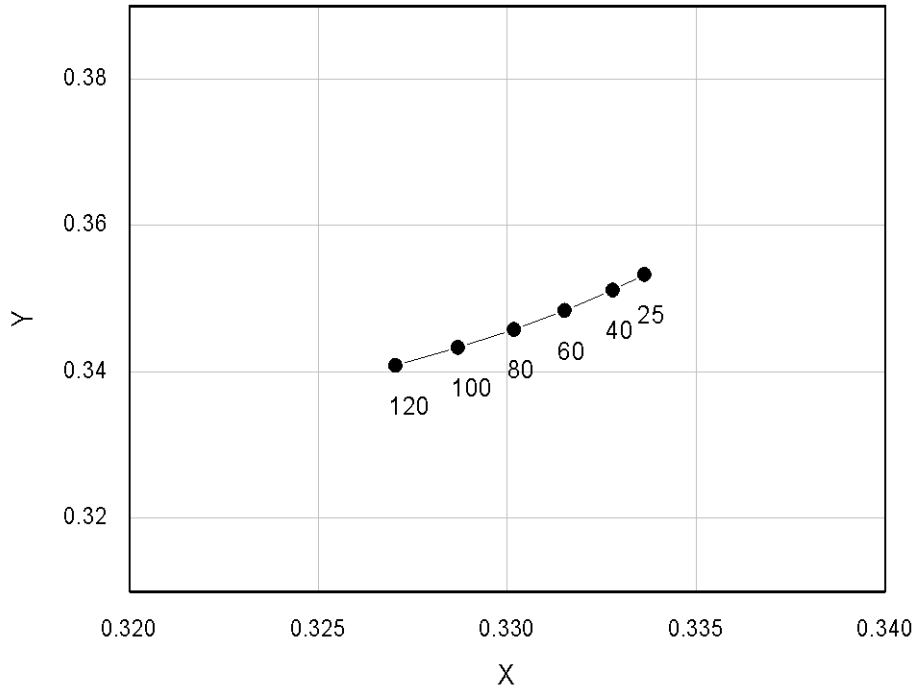
Fig 8. Chromaticity Coordinate vs. Junction Temperature $I_F=40mA$
(4200K~7000K)



Ambient Temperature Characteristics

Fig 9. Maximum Forward Current vs. Ambient Temperature

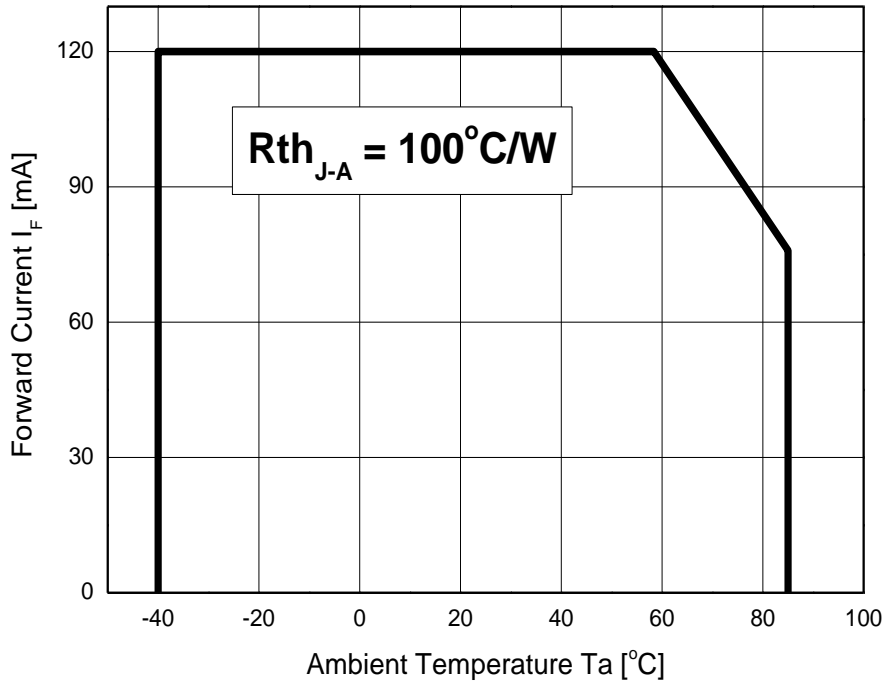

Color Bin Structure

Table 4. Bin Code description

| Part Number | Luminous Intensity (cd) @ I _F = 40mA | | | Color Chromaticity Coordinate @ I _F = 40mA | Typical Forward Voltage (V _F) @ I _F = 40mA | | |
|-------------|--|------|------|--|--|------|------|
| | Bin Code | Min. | Max. | | Bin Code | Min. | Max. |
| STW8B12B | L5 | 3.5 | 4.0 | Refer to page.14 | Y2 | 2.8 | 2.9 |
| | M0 | 4.0 | 4.5 | | Y3 | 2.9 | 3.0 |
| | M5 | 4.5 | 5.0 | | Z1 | 3.0 | 3.1 |
| | N0 | 5.0 | 5.5 | | Z2 | 3.1 | 3.2 |
| | N5 | 5.5 | 6.0 | | Z3 | 3.2 | 3.3 |

Table 5. Intensity rank distribution

Available Ranks

| CCT | CIE | IV Rank | | | | |
|-------------|-----|---------|----|----|----|----|
| 6000~7000 K | A | L5 | M0 | M5 | N0 | N5 |
| 5300~6000 K | B | L5 | M0 | M5 | N0 | N5 |
| 4700~5300 K | C | L5 | M0 | M5 | N0 | N5 |
| 4200~4700 K | D | L5 | M0 | M5 | N0 | N5 |
| 3700~4200 K | E | L5 | M0 | M5 | N0 | N5 |
| 3200~3700 K | F | L5 | M0 | M5 | N0 | N5 |
| 2900~3200 K | G | L5 | M0 | M5 | N0 | N5 |
| 2600~2900 K | H | L5 | M0 | M5 | N0 | N5 |

Notes :

- (1) All measurements were made under the standardized environment of Seoul Semiconductor.
- (2) Seoul Semiconductor sorts the LED package according to the luminous intensity IV.
- (3) The lumen table is only for reference.

Color Bin Structure

Fig 10. CIE Chromaticity Diagram $T_a=25^\circ\text{C}$, $I_F=40\text{mA}$

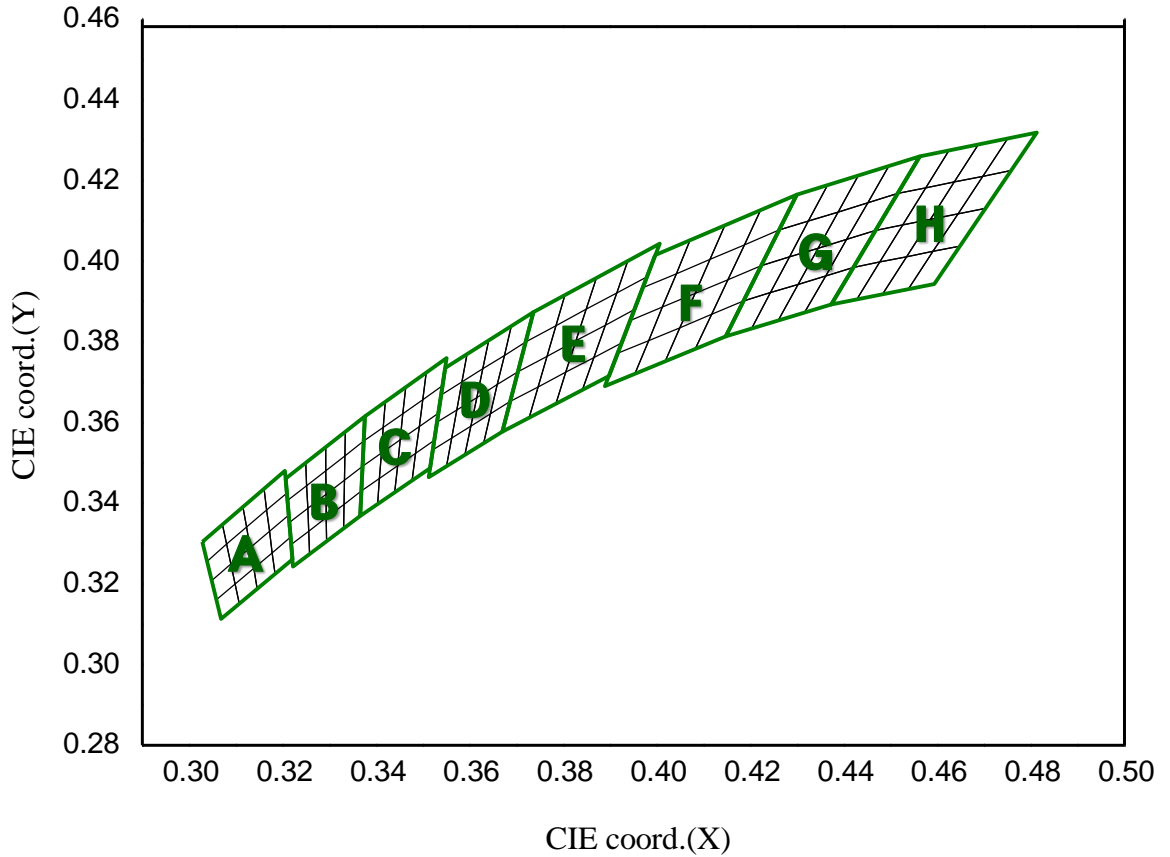

- (1) Energy Star binning applied to all 2600~7000K.
- (2) Measurement Uncertainty of the Color Coordinates : ± 0.007

Color Bin Structure

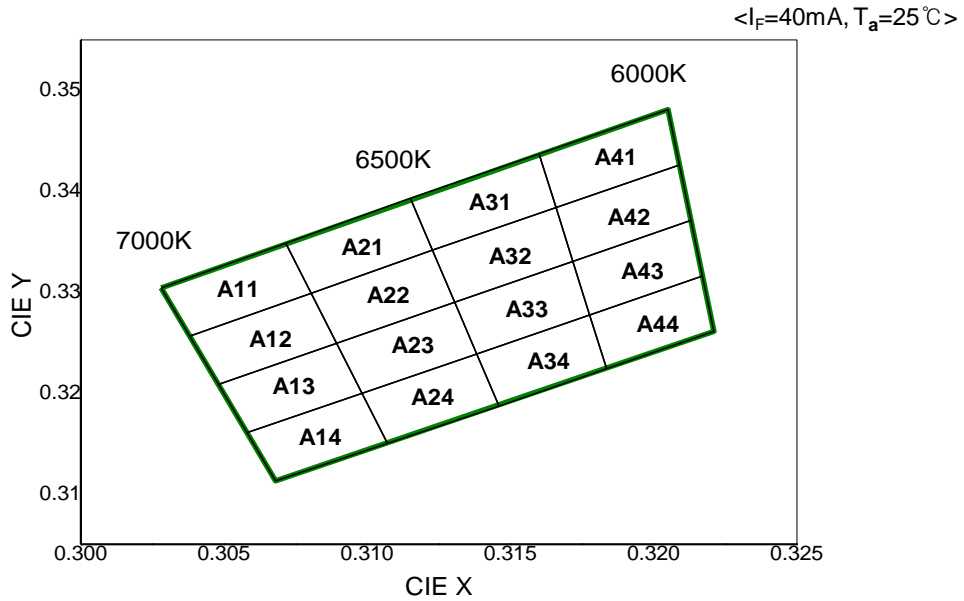

| A11 | | A21 | | A31 | | A41 | |
|--------|--------|--------|--------|--------|--------|--------|--------|
| CIE X | CIE Y | CIE X | CIE Y | CIE X | CIE Y | CIE X | CIE Y |
| 0.3028 | 0.3304 | 0.3072 | 0.3349 | 0.3115 | 0.3393 | 0.3160 | 0.3437 |
| 0.3038 | 0.3256 | 0.3080 | 0.3299 | 0.3123 | 0.3342 | 0.3166 | 0.3384 |
| 0.3080 | 0.3299 | 0.3123 | 0.3342 | 0.3166 | 0.3384 | 0.3209 | 0.3426 |
| 0.3072 | 0.3349 | 0.3115 | 0.3393 | 0.3160 | 0.3437 | 0.3205 | 0.3481 |
| A12 | | A22 | | A32 | | A42 | |
| CIE X | CIE Y | CIE X | CIE Y | CIE X | CIE Y | CIE X | CIE Y |
| 0.3038 | 0.3256 | 0.3080 | 0.3299 | 0.3123 | 0.3342 | 0.3166 | 0.3384 |
| 0.3048 | 0.3209 | 0.3089 | 0.3249 | 0.3131 | 0.3290 | 0.3172 | 0.3331 |
| 0.3089 | 0.3249 | 0.3131 | 0.3290 | 0.3172 | 0.3331 | 0.3213 | 0.3371 |
| 0.3080 | 0.3299 | 0.3123 | 0.3342 | 0.3166 | 0.3384 | 0.3209 | 0.3426 |
| A13 | | A23 | | A33 | | A43 | |
| CIE X | CIE Y | CIE X | CIE Y | CIE X | CIE Y | CIE X | CIE Y |
| 0.3048 | 0.3209 | 0.3089 | 0.3249 | 0.3131 | 0.3290 | 0.3172 | 0.3331 |
| 0.3058 | 0.3161 | 0.3098 | 0.3200 | 0.3138 | 0.3239 | 0.3178 | 0.3277 |
| 0.3098 | 0.3200 | 0.3138 | 0.3239 | 0.3178 | 0.3277 | 0.3217 | 0.3316 |
| 0.3089 | 0.3249 | 0.3131 | 0.3290 | 0.3172 | 0.3331 | 0.3213 | 0.3371 |
| A14 | | A24 | | A34 | | A44 | |
| CIE X | CIE Y | CIE X | CIE Y | CIE X | CIE Y | CIE X | CIE Y |
| 0.3058 | 0.3161 | 0.3098 | 0.3200 | 0.3138 | 0.3239 | 0.3178 | 0.3277 |
| 0.3068 | 0.3113 | 0.3107 | 0.3150 | 0.3146 | 0.3187 | 0.3184 | 0.3224 |
| 0.3107 | 0.3150 | 0.3146 | 0.3187 | 0.3184 | 0.3224 | 0.3221 | 0.3261 |
| 0.3098 | 0.3200 | 0.3138 | 0.3239 | 0.3178 | 0.3277 | 0.3217 | 0.3316 |

Color Bin Structure

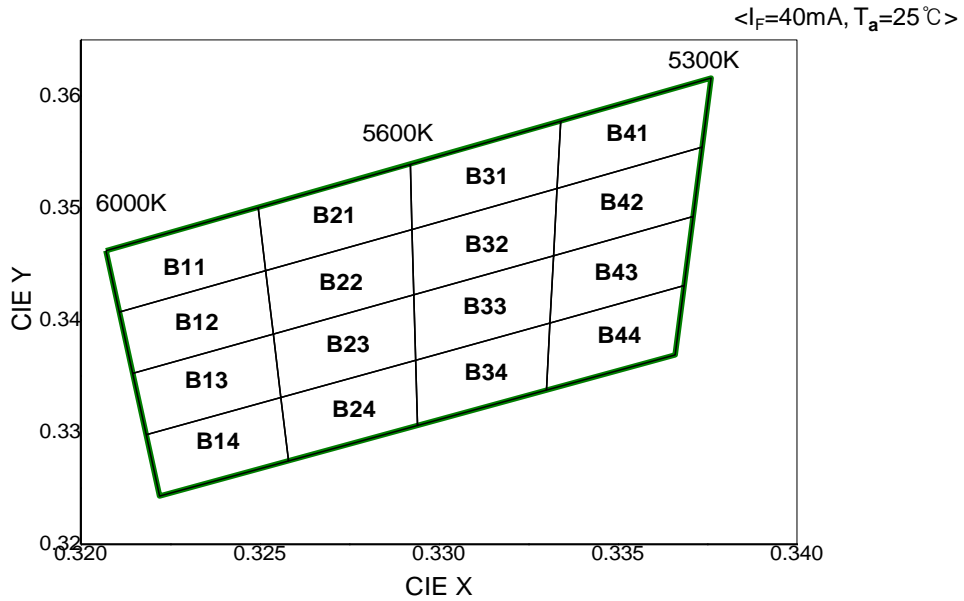

| B11 | | B21 | | B31 | | B41 | |
|--------|--------|--------|--------|--------|--------|--------|--------|
| CIE X | CIE Y | CIE X | CIE Y | CIE X | CIE Y | CIE X | CIE Y |
| 0.3207 | 0.3462 | 0.3250 | 0.3501 | 0.3292 | 0.3539 | 0.3334 | 0.3578 |
| 0.3211 | 0.3407 | 0.3252 | 0.3444 | 0.3293 | 0.3481 | 0.3333 | 0.3518 |
| 0.3252 | 0.3444 | 0.3293 | 0.3481 | 0.3333 | 0.3518 | 0.3374 | 0.3554 |
| 0.3250 | 0.3501 | 0.3292 | 0.3539 | 0.3334 | 0.3578 | 0.3376 | 0.3616 |
| B12 | | B22 | | B32 | | B42 | |
| CIE X | CIE Y | CIE X | CIE Y | CIE X | CIE Y | CIE X | CIE Y |
| 0.3211 | 0.3407 | 0.3252 | 0.3444 | 0.3293 | 0.3481 | 0.3333 | 0.3518 |
| 0.3215 | 0.3353 | 0.3254 | 0.3388 | 0.3293 | 0.3423 | 0.3332 | 0.3458 |
| 0.3254 | 0.3388 | 0.3293 | 0.3423 | 0.3332 | 0.3458 | 0.3371 | 0.3493 |
| 0.3252 | 0.3444 | 0.3293 | 0.3481 | 0.3333 | 0.3518 | 0.3374 | 0.3554 |
| B13 | | B23 | | B33 | | B43 | |
| CIE X | CIE Y | CIE X | CIE Y | CIE X | CIE Y | CIE X | CIE Y |
| 0.3215 | 0.3353 | 0.3254 | 0.3388 | 0.3293 | 0.3423 | 0.3332 | 0.3458 |
| 0.3218 | 0.3298 | 0.3256 | 0.3331 | 0.3294 | 0.3364 | 0.3331 | 0.3398 |
| 0.3256 | 0.3331 | 0.3294 | 0.3364 | 0.3331 | 0.3398 | 0.3369 | 0.3431 |
| 0.3254 | 0.3388 | 0.3293 | 0.3423 | 0.3332 | 0.3458 | 0.3371 | 0.3493 |
| B14 | | B24 | | B34 | | B44 | |
| CIE X | CIE Y | CIE X | CIE Y | CIE X | CIE Y | CIE X | CIE Y |
| 0.3218 | 0.3298 | 0.3256 | 0.3331 | 0.3294 | 0.3364 | 0.3331 | 0.3398 |
| 0.3222 | 0.3243 | 0.3258 | 0.3275 | 0.3294 | 0.3306 | 0.3330 | 0.3338 |
| 0.3258 | 0.3275 | 0.3294 | 0.3306 | 0.3330 | 0.3338 | 0.3366 | 0.3369 |
| 0.3256 | 0.3331 | 0.3294 | 0.3364 | 0.3331 | 0.3398 | 0.3369 | 0.3431 |

Color Bin Structure

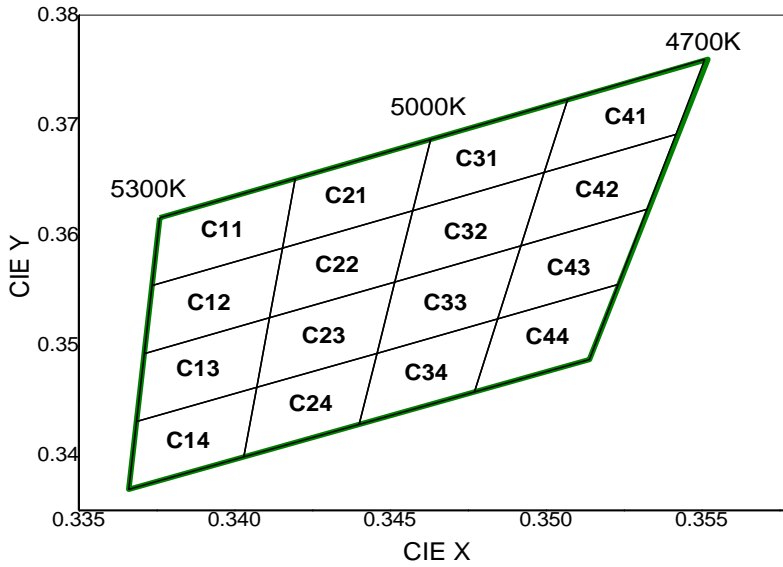
 $\langle I_F=40\text{mA}, T_a=25^\circ\text{C} \rangle$

| C11 | | C21 | | C31 | | C41 | |
|--------|--------|--------|--------|--------|--------|--------|--------|
| CIE X | CIE Y | CIE X | CIE Y | CIE X | CIE Y | CIE X | CIE Y |
| 0.3376 | 0.3616 | 0.3420 | 0.3652 | 0.3463 | 0.3687 | 0.3507 | 0.3724 |
| 0.3374 | 0.3554 | 0.3415 | 0.3588 | 0.3457 | 0.3622 | 0.3500 | 0.3657 |
| 0.3415 | 0.3588 | 0.3457 | 0.3622 | 0.3500 | 0.3657 | 0.3542 | 0.3692 |
| 0.3420 | 0.3652 | 0.3463 | 0.3687 | 0.3507 | 0.3724 | 0.3551 | 0.3760 |
| C12 | | C22 | | C32 | | C42 | |
| CIE X | CIE Y | CIE X | CIE Y | CIE X | CIE Y | CIE X | CIE Y |
| 0.3374 | 0.3554 | 0.3415 | 0.3588 | 0.3457 | 0.3622 | 0.3500 | 0.3657 |
| 0.3371 | 0.3493 | 0.3411 | 0.3525 | 0.3452 | 0.3558 | 0.3492 | 0.3591 |
| 0.3411 | 0.3525 | 0.3452 | 0.3558 | 0.3492 | 0.3591 | 0.3533 | 0.3624 |
| 0.3415 | 0.3588 | 0.3457 | 0.3622 | 0.3500 | 0.3657 | 0.3542 | 0.3692 |
| C13 | | C23 | | C33 | | C43 | |
| CIE X | CIE Y | CIE X | CIE Y | CIE X | CIE Y | CIE X | CIE Y |
| 0.3371 | 0.3493 | 0.3411 | 0.3525 | 0.3452 | 0.3558 | 0.3492 | 0.3591 |
| 0.3369 | 0.3431 | 0.3407 | 0.3462 | 0.3446 | 0.3493 | 0.3485 | 0.3524 |
| 0.3407 | 0.3462 | 0.3446 | 0.3493 | 0.3485 | 0.3524 | 0.3523 | 0.3555 |
| 0.3411 | 0.3525 | 0.3452 | 0.3558 | 0.3492 | 0.3591 | 0.3533 | 0.3624 |
| C14 | | C24 | | C34 | | C44 | |
| CIE X | CIE Y | CIE X | CIE Y | CIE X | CIE Y | CIE X | CIE Y |
| 0.3369 | 0.3431 | 0.3407 | 0.3462 | 0.3446 | 0.3493 | 0.3485 | 0.3524 |
| 0.3366 | 0.3369 | 0.3403 | 0.3399 | 0.3440 | 0.3428 | 0.3477 | 0.3458 |
| 0.3403 | 0.3399 | 0.3440 | 0.3428 | 0.3477 | 0.3458 | 0.3514 | 0.3487 |
| 0.3407 | 0.3462 | 0.3446 | 0.3493 | 0.3485 | 0.3524 | 0.3523 | 0.3555 |

Color Bin Structure

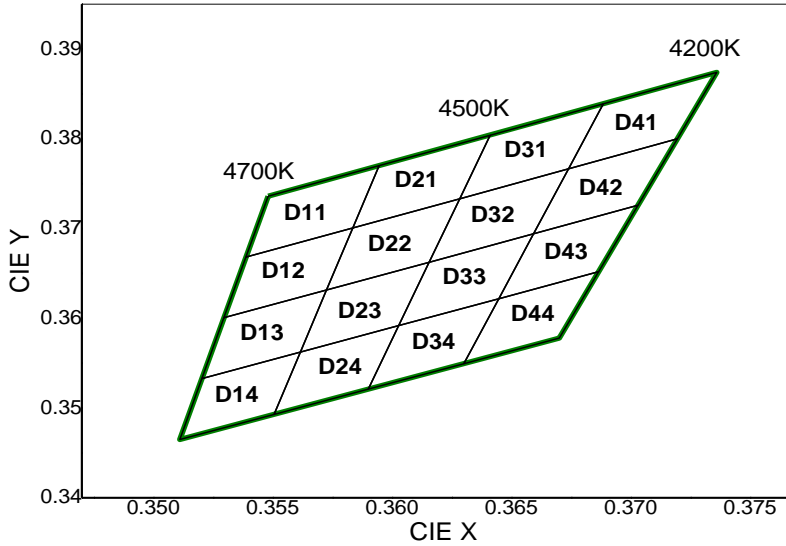
 $\langle I_F=40\text{mA}, T_a=25^\circ\text{C} \rangle$

| D11 | | D21 | | D31 | | D41 | |
|--------|--------|--------|--------|--------|--------|--------|--------|
| CIE X | CIE Y | CIE X | CIE Y | CIE X | CIE Y | CIE X | CIE Y |
| 0.3548 | 0.3736 | 0.3595 | 0.3770 | 0.3641 | 0.3804 | 0.3689 | 0.3839 |
| 0.3539 | 0.3668 | 0.3584 | 0.3701 | 0.3628 | 0.3733 | 0.3674 | 0.3767 |
| 0.3584 | 0.3701 | 0.3628 | 0.3733 | 0.3674 | 0.3767 | 0.3720 | 0.3800 |
| 0.3595 | 0.3770 | 0.3641 | 0.3804 | 0.3689 | 0.3839 | 0.3736 | 0.3874 |
| D12 | | D22 | | D32 | | D42 | |
| CIE X | CIE Y | CIE X | CIE Y | CIE X | CIE Y | CIE X | CIE Y |
| 0.3539 | 0.3668 | 0.3584 | 0.3701 | 0.3628 | 0.3733 | 0.3674 | 0.3767 |
| 0.3530 | 0.3601 | 0.3573 | 0.3632 | 0.3616 | 0.3663 | 0.3659 | 0.3694 |
| 0.3573 | 0.3632 | 0.3616 | 0.3663 | 0.3659 | 0.3694 | 0.3703 | 0.3726 |
| 0.3584 | 0.3701 | 0.3628 | 0.3733 | 0.3674 | 0.3767 | 0.3720 | 0.3800 |
| D13 | | D23 | | D33 | | D43 | |
| CIE X | CIE Y | CIE X | CIE Y | CIE X | CIE Y | CIE X | CIE Y |
| 0.3530 | 0.3601 | 0.3573 | 0.3632 | 0.3616 | 0.3663 | 0.3659 | 0.3694 |
| 0.3520 | 0.3533 | 0.3562 | 0.3562 | 0.3603 | 0.3592 | 0.3645 | 0.3622 |
| 0.3562 | 0.3562 | 0.3603 | 0.3592 | 0.3645 | 0.3622 | 0.3687 | 0.3652 |
| 0.3573 | 0.3632 | 0.3616 | 0.3663 | 0.3659 | 0.3694 | 0.3703 | 0.3726 |
| D14 | | D24 | | D34 | | D44 | |
| CIE X | CIE Y | CIE X | CIE Y | CIE X | CIE Y | CIE X | CIE Y |
| 0.3520 | 0.3533 | 0.3562 | 0.3562 | 0.3603 | 0.3592 | 0.3645 | 0.3622 |
| 0.3511 | 0.3465 | 0.3551 | 0.3493 | 0.3590 | 0.3521 | 0.3630 | 0.3550 |
| 0.3551 | 0.3493 | 0.3590 | 0.3521 | 0.3630 | 0.3550 | 0.3670 | 0.3578 |
| 0.3562 | 0.3562 | 0.3603 | 0.3592 | 0.3645 | 0.3622 | 0.3687 | 0.3652 |

Color Bin Structure

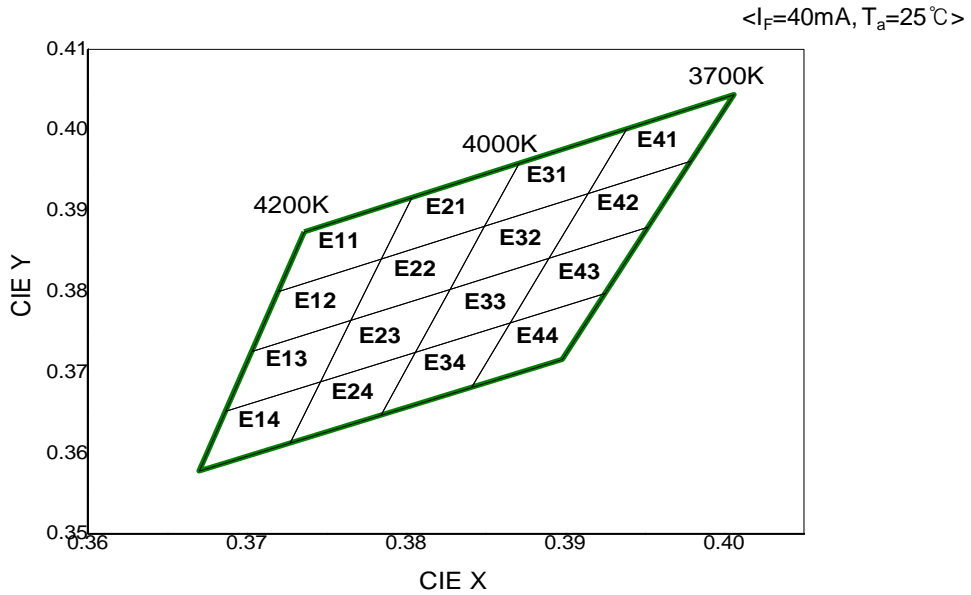

| E11 | | E21 | | E31 | | E41 | |
|--------|--------|--------|--------|--------|--------|--------|--------|
| CIE X | CIE Y | CIE X | CIE Y | CIE X | CIE Y | CIE X | CIE Y |
| 0.3736 | 0.3874 | 0.3804 | 0.3917 | 0.3871 | 0.3959 | 0.3939 | 0.4002 |
| 0.3720 | 0.3800 | 0.3784 | 0.3841 | 0.3849 | 0.3881 | 0.3914 | 0.3922 |
| 0.3784 | 0.3841 | 0.3849 | 0.3881 | 0.3914 | 0.3922 | 0.3979 | 0.3962 |
| 0.3804 | 0.3917 | 0.3871 | 0.3959 | 0.3939 | 0.4002 | 0.4006 | 0.4044 |
| E12 | | E22 | | E32 | | E42 | |
| CIE X | CIE Y | CIE X | CIE Y | CIE X | CIE Y | CIE X | CIE Y |
| 0.3720 | 0.3800 | 0.3784 | 0.3841 | 0.3849 | 0.3881 | 0.3914 | 0.3922 |
| 0.3703 | 0.3726 | 0.3765 | 0.3765 | 0.3828 | 0.3803 | 0.3890 | 0.3842 |
| 0.3765 | 0.3765 | 0.3828 | 0.3803 | 0.3890 | 0.3842 | 0.3952 | 0.3880 |
| 0.3784 | 0.3841 | 0.3849 | 0.3881 | 0.3914 | 0.3922 | 0.3979 | 0.3962 |
| E13 | | E23 | | E33 | | E43 | |
| CIE X | CIE Y | CIE X | CIE Y | CIE X | CIE Y | CIE X | CIE Y |
| 0.3703 | 0.3726 | 0.3765 | 0.3765 | 0.3828 | 0.3803 | 0.3890 | 0.3842 |
| 0.3687 | 0.3652 | 0.3746 | 0.3689 | 0.3806 | 0.3725 | 0.3865 | 0.3762 |
| 0.3746 | 0.3689 | 0.3806 | 0.3725 | 0.3865 | 0.3762 | 0.3925 | 0.3798 |
| 0.3765 | 0.3765 | 0.3828 | 0.3803 | 0.3890 | 0.3842 | 0.3952 | 0.3880 |
| E14 | | E24 | | E34 | | E44 | |
| CIE X | CIE Y | CIE X | CIE Y | CIE X | CIE Y | CIE X | CIE Y |
| 0.3687 | 0.3652 | 0.3746 | 0.3689 | 0.3806 | 0.3725 | 0.3865 | 0.3762 |
| 0.3670 | 0.3578 | 0.3727 | 0.3613 | 0.3784 | 0.3647 | 0.3841 | 0.3682 |
| 0.3727 | 0.3613 | 0.3784 | 0.3647 | 0.3841 | 0.3682 | 0.3898 | 0.3716 |
| 0.3746 | 0.3689 | 0.3806 | 0.3725 | 0.3865 | 0.3762 | 0.3925 | 0.3798 |

Color Bin Structure

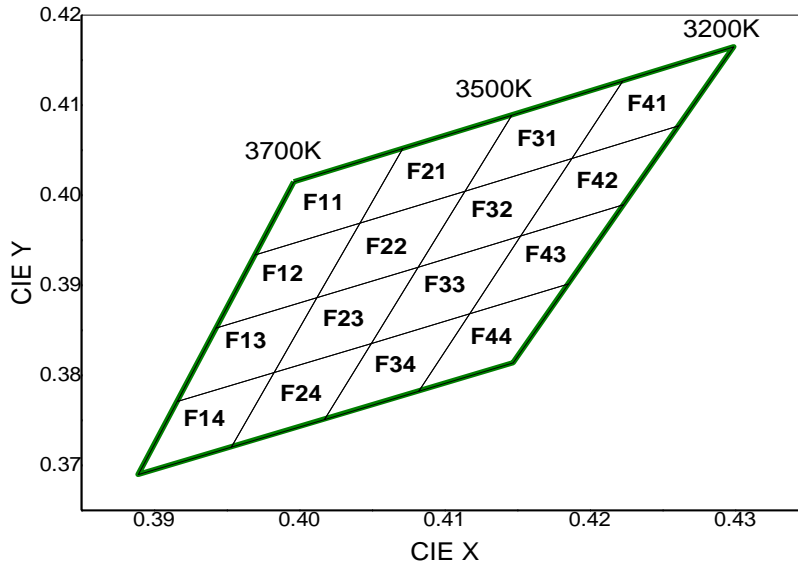
 $\langle I_F=40\text{mA}, T_a=25^\circ\text{C} \rangle$

| F11 | | F21 | | F31 | | F41 | |
|--------|--------|--------|--------|--------|--------|--------|--------|
| CIE X | CIE Y | CIE X | CIE Y | CIE X | CIE Y | CIE X | CIE Y |
| 0.3996 | 0.4015 | 0.4071 | 0.4052 | 0.4146 | 0.4089 | 0.4223 | 0.4127 |
| 0.3969 | 0.3934 | 0.4042 | 0.3969 | 0.4114 | 0.4005 | 0.4187 | 0.4041 |
| 0.4042 | 0.3969 | 0.4114 | 0.4005 | 0.4187 | 0.4041 | 0.4261 | 0.4077 |
| 0.4071 | 0.4052 | 0.4146 | 0.4089 | 0.4223 | 0.4127 | 0.4299 | 0.4165 |
| F12 | | F22 | | F32 | | F42 | |
| CIE X | CIE Y | CIE X | CIE Y | CIE X | CIE Y | CIE X | CIE Y |
| 0.3969 | 0.3934 | 0.4042 | 0.3969 | 0.4114 | 0.4005 | 0.4187 | 0.4041 |
| 0.3943 | 0.3853 | 0.4012 | 0.3886 | 0.4082 | 0.3920 | 0.4152 | 0.3955 |
| 0.4012 | 0.3886 | 0.4082 | 0.3920 | 0.4152 | 0.3955 | 0.4223 | 0.3990 |
| 0.4042 | 0.3969 | 0.4114 | 0.4005 | 0.4187 | 0.4041 | 0.4261 | 0.4077 |
| F13 | | F23 | | F33 | | F43 | |
| CIE X | CIE Y | CIE X | CIE Y | CIE X | CIE Y | CIE X | CIE Y |
| 0.3943 | 0.3853 | 0.4012 | 0.3886 | 0.4082 | 0.3920 | 0.4152 | 0.3955 |
| 0.3916 | 0.3771 | 0.3983 | 0.3803 | 0.4049 | 0.3836 | 0.4117 | 0.3869 |
| 0.3983 | 0.3803 | 0.4049 | 0.3836 | 0.4117 | 0.3869 | 0.4185 | 0.3902 |
| 0.4012 | 0.3886 | 0.4082 | 0.3920 | 0.4152 | 0.3955 | 0.4223 | 0.3990 |
| F14 | | F24 | | F34 | | F44 | |
| CIE X | CIE Y | CIE X | CIE Y | CIE X | CIE Y | CIE X | CIE Y |
| 0.3916 | 0.3771 | 0.3983 | 0.3803 | 0.4049 | 0.3836 | 0.4117 | 0.3869 |
| 0.3889 | 0.3690 | 0.3953 | 0.3721 | 0.4017 | 0.3751 | 0.4082 | 0.3783 |
| 0.3953 | 0.3721 | 0.4017 | 0.3751 | 0.4082 | 0.3783 | 0.4147 | 0.3814 |
| 0.3983 | 0.3803 | 0.4049 | 0.3836 | 0.4117 | 0.3869 | 0.4185 | 0.3902 |

Color Bin Structure

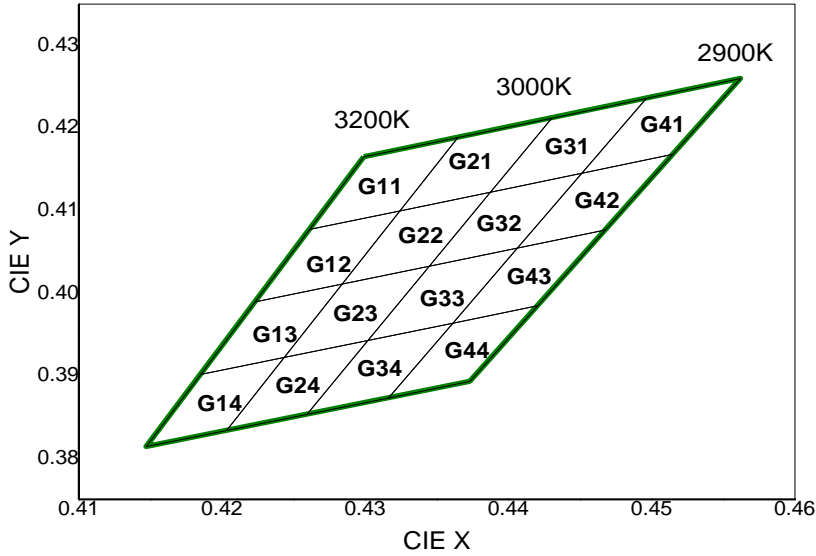
 $\langle I_F=40\text{mA}, T_a=25^\circ\text{C} \rangle$

| G11 | | G21 | | G31 | | G41 | |
|--------|--------|--------|--------|--------|--------|--------|--------|
| CIE X | CIE Y | CIE X | CIE Y | CIE X | CIE Y | CIE X | CIE Y |
| 0.4299 | 0.4165 | 0.4364 | 0.4188 | 0.4430 | 0.4212 | 0.4496 | 0.4236 |
| 0.4261 | 0.4077 | 0.4324 | 0.4099 | 0.4387 | 0.4122 | 0.4451 | 0.4145 |
| 0.4324 | 0.4100 | 0.4387 | 0.4122 | 0.4451 | 0.4145 | 0.4514 | 0.4168 |
| 0.4365 | 0.4189 | 0.4430 | 0.4212 | 0.4496 | 0.4236 | 0.4562 | 0.4260 |
| G12 | | G22 | | G32 | | G42 | |
| CIE X | CIE Y | CIE X | CIE Y | CIE X | CIE Y | CIE X | CIE Y |
| 0.4261 | 0.4077 | 0.4324 | 0.4100 | 0.4387 | 0.4122 | 0.4451 | 0.4145 |
| 0.4223 | 0.3990 | 0.4284 | 0.4011 | 0.4345 | 0.4033 | 0.4406 | 0.4055 |
| 0.4284 | 0.4011 | 0.4345 | 0.4033 | 0.4406 | 0.4055 | 0.4468 | 0.4077 |
| 0.4324 | 0.4100 | 0.4387 | 0.4122 | 0.4451 | 0.4145 | 0.4515 | 0.4168 |
| G13 | | G23 | | G33 | | G43 | |
| CIE X | CIE Y | CIE X | CIE Y | CIE X | CIE Y | CIE X | CIE Y |
| 0.4223 | 0.3990 | 0.4284 | 0.4011 | 0.4345 | 0.4033 | 0.4406 | 0.4055 |
| 0.4185 | 0.3902 | 0.4243 | 0.3922 | 0.4302 | 0.3943 | 0.4361 | 0.3964 |
| 0.4243 | 0.3922 | 0.4302 | 0.3943 | 0.4361 | 0.3964 | 0.4420 | 0.3985 |
| 0.4284 | 0.4011 | 0.4345 | 0.4033 | 0.4406 | 0.4055 | 0.4468 | 0.4077 |
| G14 | | G24 | | G34 | | G44 | |
| CIE X | CIE Y | CIE X | CIE Y | CIE X | CIE Y | CIE X | CIE Y |
| 0.4243 | 0.3922 | 0.4302 | 0.3943 | 0.4302 | 0.3943 | 0.4361 | 0.3964 |
| 0.4203 | 0.3834 | 0.4259 | 0.3853 | 0.4259 | 0.3853 | 0.4316 | 0.3873 |
| 0.4147 | 0.3814 | 0.4203 | 0.3834 | 0.4316 | 0.3873 | 0.4373 | 0.3893 |
| 0.4185 | 0.3902 | 0.4243 | 0.3922 | 0.4361 | 0.3964 | 0.4420 | 0.3985 |

Color Bin Structure

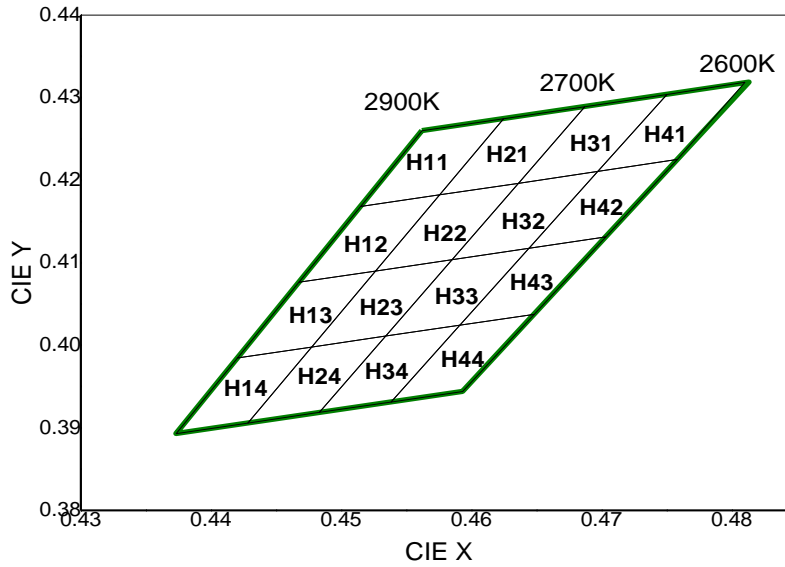
 $\langle I_F=40\text{mA}, T_a=25^\circ\text{C} \rangle$

| H11 | | H21 | | H31 | | H41 | |
|--------|--------|--------|--------|--------|--------|--------|--------|
| CIE X | CIE Y | CIE X | CIE Y | CIE X | CIE Y | CIE X | CIE Y |
| 0.4562 | 0.4260 | 0.4625 | 0.4275 | 0.4687 | 0.4289 | 0.4750 | 0.4304 |
| 0.4515 | 0.4168 | 0.4575 | 0.4182 | 0.4636 | 0.4197 | 0.4697 | 0.4211 |
| 0.4575 | 0.4182 | 0.4636 | 0.4197 | 0.4697 | 0.4211 | 0.4758 | 0.4225 |
| 0.4625 | 0.4275 | 0.4687 | 0.4289 | 0.4750 | 0.4304 | 0.4810 | 0.4319 |
| H12 | | H22 | | H32 | | H42 | |
| CIE X | CIE Y | CIE X | CIE Y | CIE X | CIE Y | CIE X | CIE Y |
| 0.4515 | 0.4168 | 0.4575 | 0.4182 | 0.4636 | 0.4197 | 0.4697 | 0.4211 |
| 0.4468 | 0.4077 | 0.4526 | 0.4090 | 0.4585 | 0.4104 | 0.4644 | 0.4118 |
| 0.4526 | 0.4090 | 0.4585 | 0.4104 | 0.4644 | 0.4118 | 0.4703 | 0.4132 |
| 0.4575 | 0.4182 | 0.4636 | 0.4197 | 0.4697 | 0.4211 | 0.4758 | 0.4225 |
| H13 | | H23 | | H33 | | H43 | |
| CIE X | CIE Y | CIE X | CIE Y | CIE X | CIE Y | CIE X | CIE Y |
| 0.4468 | 0.4077 | 0.4526 | 0.4090 | 0.4585 | 0.4104 | 0.4644 | 0.4118 |
| 0.4420 | 0.3985 | 0.4477 | 0.3998 | 0.4534 | 0.4012 | 0.4591 | 0.4025 |
| 0.4477 | 0.3998 | 0.4534 | 0.4012 | 0.4591 | 0.4025 | 0.4648 | 0.4038 |
| 0.4526 | 0.4090 | 0.4585 | 0.4104 | 0.4644 | 0.4118 | 0.4703 | 0.4132 |
| H14 | | H24 | | H34 | | H44 | |
| CIE X | CIE Y | CIE X | CIE Y | CIE X | CIE Y | CIE X | CIE Y |
| 0.4420 | 0.3985 | 0.4477 | 0.3998 | 0.4534 | 0.4012 | 0.4591 | 0.4025 |
| 0.4373 | 0.3893 | 0.4428 | 0.3906 | 0.4483 | 0.3919 | 0.4538 | 0.3932 |
| 0.4428 | 0.3906 | 0.4483 | 0.3919 | 0.4538 | 0.3932 | 0.4593 | 0.3944 |
| 0.4477 | 0.3998 | 0.4534 | 0.4012 | 0.4591 | 0.4025 | 0.4648 | 0.4038 |

Mechanical Dimensions

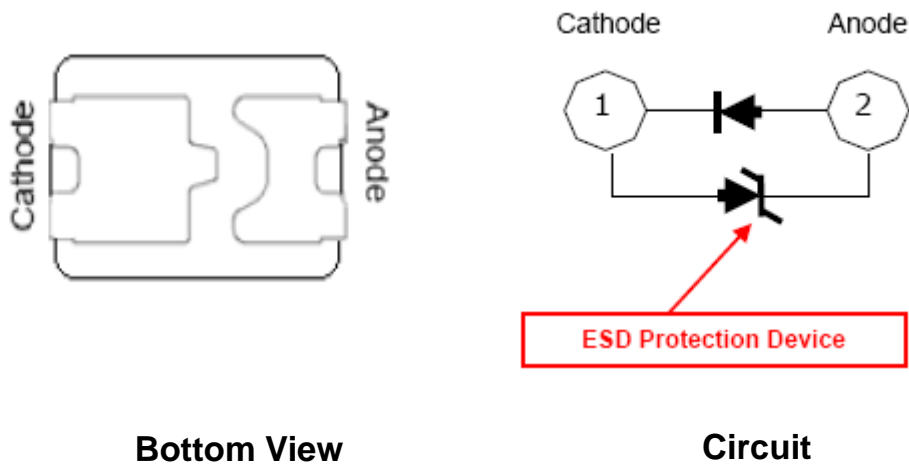
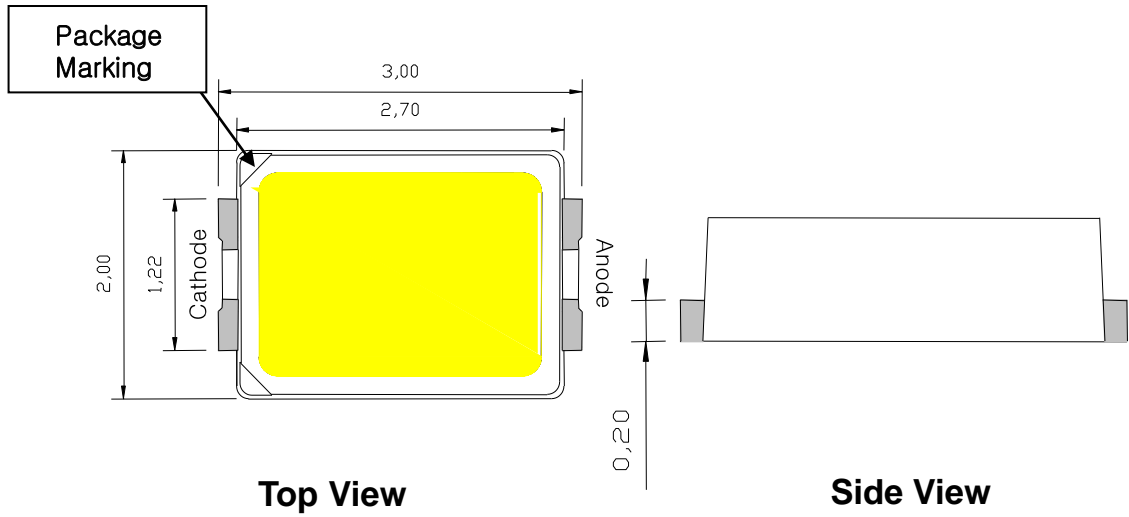

Notes :

- (1) All dimensions are in millimeters.
- (2) Scale : none
- (3) Undefined tolerance is $\pm 0.2\text{mm}$

Reel Packaging

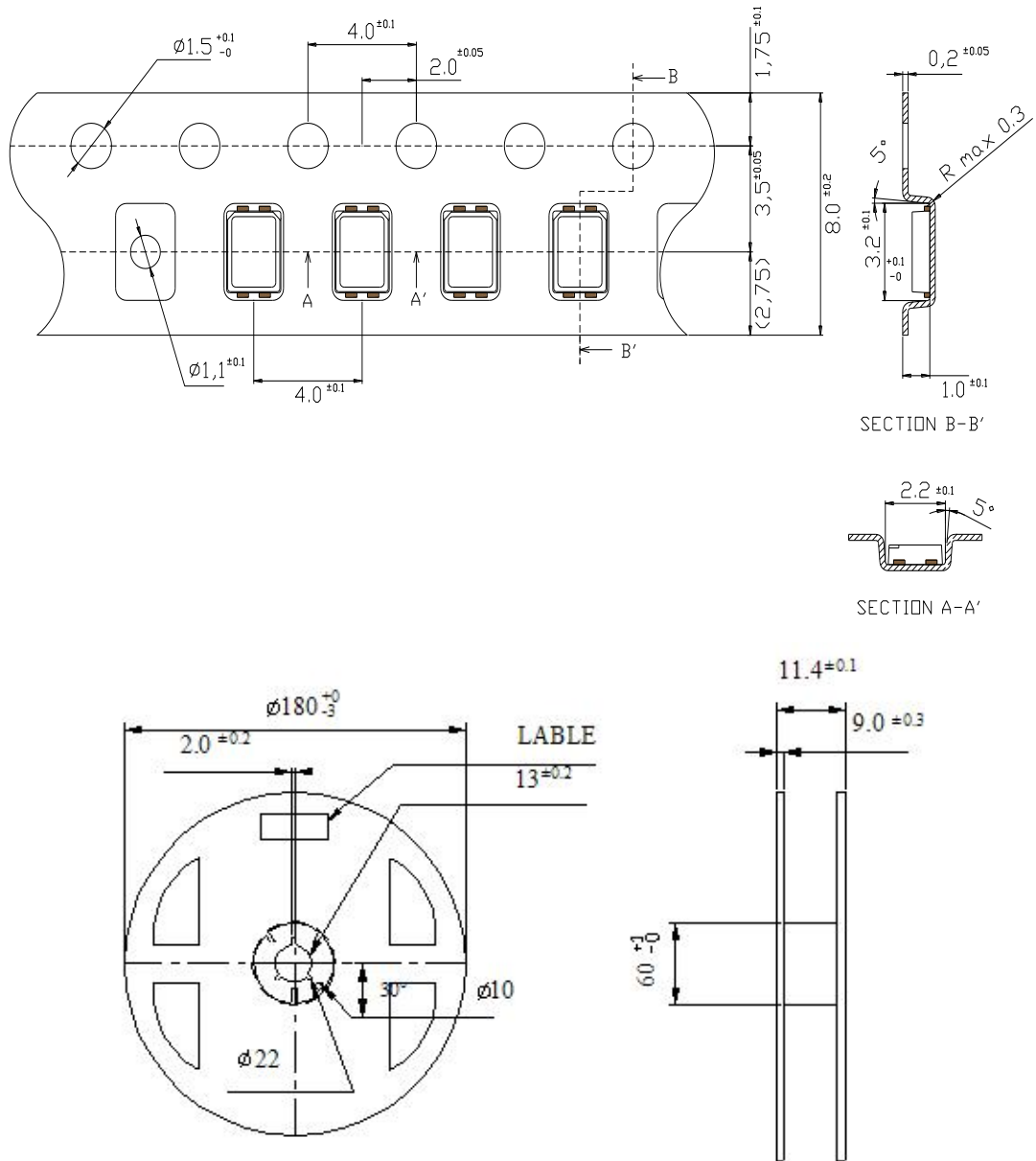

(Tolerance: ± 0.2 , Unit: mm)

- (1) Quantity : Max 4,000pcs/Reel
- (2) Cumulative Tolerance : Cumulative Tolerance/10 pitches to be ± 0.2 mm
- (3) Adhesion Strength of Cover Tape
Adhesion strength to be 0.1-0.7N when the cover tape is turned off from the carrier tape at the angle of 10° to the carrier tape.
- (4) Package : P/N, Manufacturing data Code No. and Quantity to be indicated on a damp proof Package.

Emitter Tape & Reel Packaging

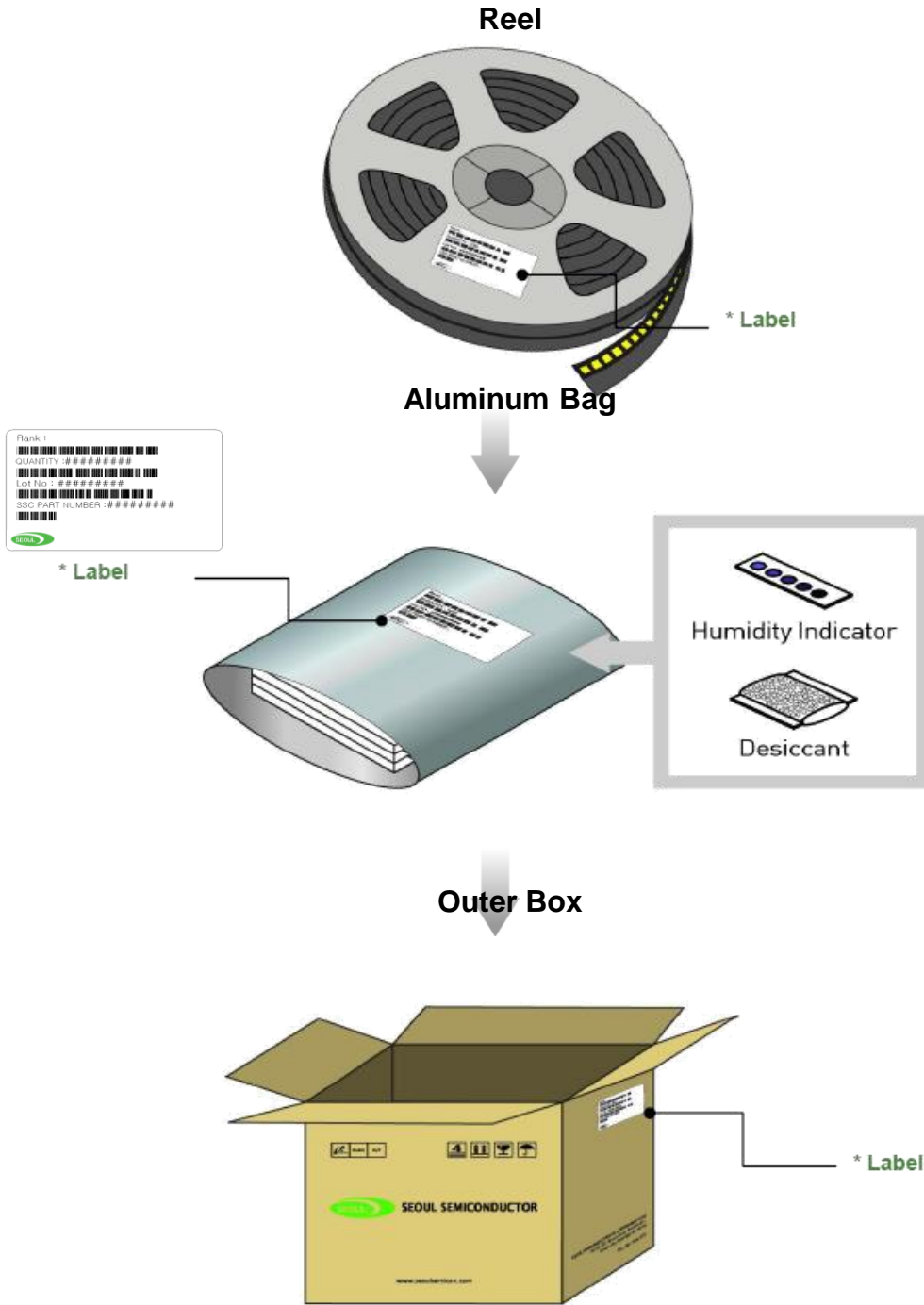

Emitter Tape & Reel Packaging

Table 6. Part Numbering System : X₁X₂X₃X₄X₅X₆X₇

| Part Number Code | Description | Part Number | Value |
|-------------------------------|---------------------|-------------|----------|
| X ₁ | Company | S | |
| X ₂ | Top View LED series | T | |
| X ₃ | Color Specification | W8 | CRI 80 |
| X ₄ | Package series | B | B series |
| X ₅ X ₆ | Characteristic code | 12 | |
| X ₇ | Revision | B | |

Table 7. Lot Numbering System : Y₁Y₂Y₃Y₄Y₅Y₆Y₇Y₈Y₉Y₁₀-Y₁₁Y₁₂Y₁₃Y₁₄Y₁₅Y₁₆Y₁₇

| Lot Number Code | Description | Lot Number | Value |
|---|---------------------|------------|-------|
| Y ₁ Y ₂ | Year | | |
| Y ₃ | Month | | |
| Y ₄ Y ₅ | Day | | |
| Y ₆ | Top View LED series | | |
| Y ₇ Y ₈ Y ₉ Y ₁₀ | Mass order | | |
| Y ₁₁ Y ₁₂ Y ₁₃ Y ₁₄ Y ₁₅ Y ₁₆ Y ₁₇ | Internal Number | | |

Recommended Solder Pad

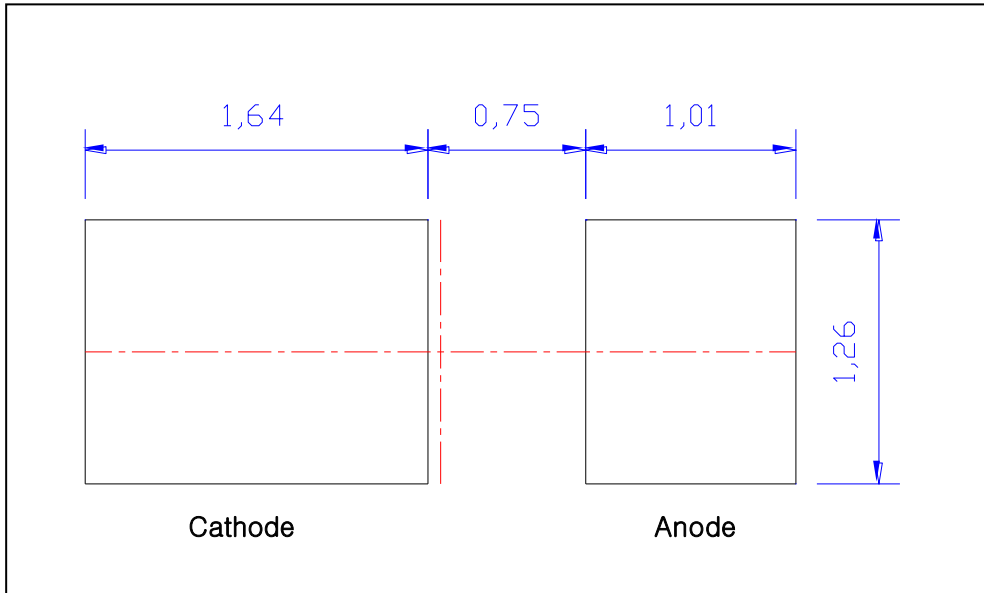

[Recommended Solder Pattern]

Notes :

- (1) All dimensions are in millimeters.
- (2) Scale : none
- (3) This drawing without tolerances are for reference only
- (4) Undefined tolerance is $\pm 0.1\text{mm}$

Reflow Soldering Characteristics

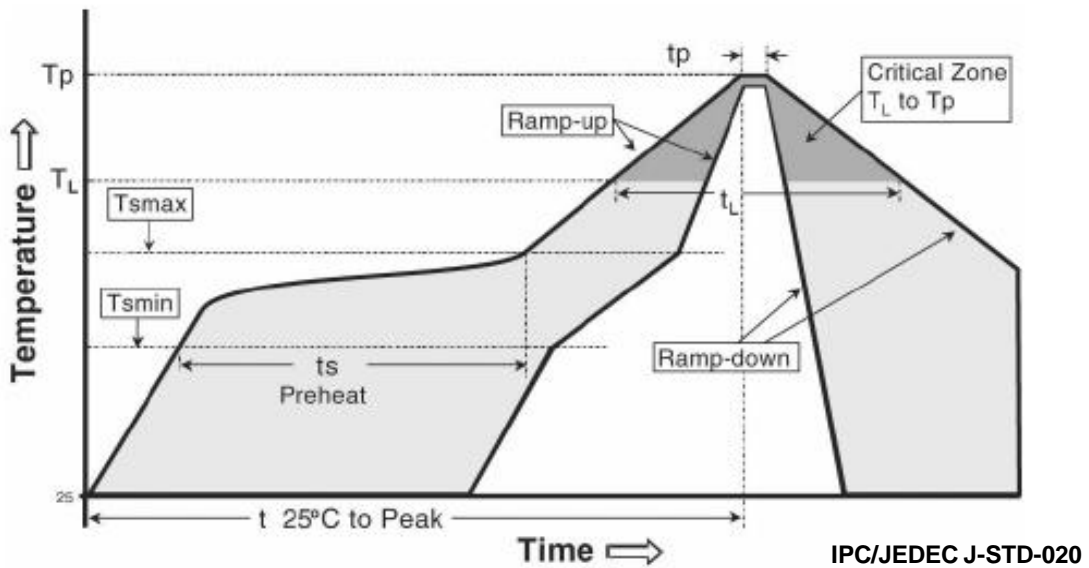
Table 8.

| Profile Feature | Sn-Pb Eutectic Assembly | Pb-Free Assembly |
|--|------------------------------------|------------------------------------|
| Average ramp-up rate (T_{smax} to T_p) | 3° C/second max. | 3° C/second max. |
| Preheat - Temperature Min (T_{smin}) - Temperature Max (T_{smax}) - Time (T_{smin} to T_{smax}) (t_s) | 100 °C 150 °C 60-120 seconds | 150 °C 200 °C 60-180 seconds |
| Time maintained above: - Temperature (T_L) - Time (t_L) | 183 °C 60-150 seconds | 217 °C 60-150 seconds |
| Peak Temperature (T_p) | 215 °C | 260 °C |
| Time within 5°C of actual Peak Temperature (t_p) ² | 10-30 seconds | 20-40 seconds |
| Ramp-down Rate | 6 °C/second max. | 6 °C/second max. |
| Time 25°C to Peak Temperature | 6 minutes max. | 8 minutes max. |

Caution

- (1) Reflow soldering is recommended not to be done more than two times. In the case of more than 24 hours passed soldering after first, LEDs will be damaged.
- (2) Repairs should not be done after the LEDs have been soldered. When repair is unavoidable, suitable tools must be used.
- (3) Die slug is to be soldered.
- (4) When soldering, do not put stress on the LEDs during heating.
- (5) After soldering, do not warp the circuit board.

Handling of Silicone Resin for LEDs

(1) During processing, mechanical stress on the surface should be minimized as much as possible. Sharp objects of all types should not be used to pierce the sealing compound.



(2) In general, LEDs should only be handled from the side. By the way, this also applies to LEDs without a silicone sealant, since the surface can also become scratched.



(3) When populating boards in SMT production, there are basically no restrictions regarding the form of the pick and place nozzle, except that mechanical pressure on the surface of the resin must be prevented. This is assured by choosing a pick and place nozzle which is larger than the LED's reflector area.

(4) Silicone differs from materials conventionally used for the manufacturing of LEDs. These conditions must be considered during the handling of such devices. Compared to standard encapsulants, silicone is generally softer, and the surface is more likely to attract dust.

As mentioned previously, the increased sensitivity to dust requires special care during processing. In cases where a minimal level of dirt and dust particles cannot be guaranteed, a suitable cleaning solution must be applied to the surface after the soldering of components.

(5) SSC suggests using isopropyl alcohol for cleaning. In case other solvents are used, it must be assured that these solvents do not dissolve the package or resin.

Ultrasonic cleaning is not recommended. Ultrasonic cleaning may cause damage to the LED.

(6) Please do not mold this product into another resin (epoxy, urethane, etc) and do not handle this product with acid or sulfur material in sealed space.

Precaution for Use

(1) Storage

To avoid the moisture penetration, we recommend store in a dry box with a desiccant .

The recommended storage temperature range is 5 °C to 30 °C and a maximum humidity of RH50%.

(2) Use Precaution after Opening the Packaging

Use proper SMT techniques when the LED is to be soldered dipped as separation of the lens may affect the light output efficiency.

Pay attention to the following:

a. Recommend conditions after opening the package

- Sealing

- Temperature : 5 ~ 40 °C Humidity : less than RH30%

b. If the package has been opened more than 4 week(MSL_2a) or the color of the desiccant changes, components should be dried for 10-12hr at 60±5 °C

(3) Do not apply mechanical force or excess vibration during the cooling process to normal temperature after soldering.

(4) Do not rapidly cool device after soldering.

(5) Components should not be mounted on warped (non coplanar) portion of PCB.

(6) Radioactive exposure is not considered for the products listed here in.

(7) Gallium arsenide is used in some of the products listed in this publication.

These products are dangerous if they are burned or shredded in the process of disposal.

It is also dangerous to drink the liquid or inhale the gas generated by such products when chemically disposed of.

(8) This device should not be used in any type of fluid such as water, oil, organic solvent and etc. When washing is required, IPA (Isopropyl Alcohol) should be used.

(9) When the LEDs are in operation the maximum current should be decided after measuring the package temperature.

(10) LEDs must be stored properly to maintain the device. If the LEDs are stored for 3 months or more after being shipped from SSC, a sealed container with a nitrogen atmosphere should be used for storage.

(11) The appearance and specifications of the product may be modified for improvement without notice.

(12) Long time exposure of sunlight or occasional UV exposure will cause lens discoloration.

(13) VOCs (Volatile organic compounds) emitted from materials used in the construction of fixtures can penetrate silicone encapsulants of LEDs and discolor when exposed to heat and photonic energy.

The result can be a significant loss of light output from the fixture.

Knowledge of the properties of the materials selected to be used in the construction of fixtures can help prevent these issues.

(14) Attaching LEDs, do not use adhesives that outgas organic vapor.

(15) The driving circuit must be designed to allow forward voltage only when it is ON or OFF.

If the reverse voltage is applied to LED, migration can be generated resulting in LED damage.



Company Information

Published by

Seoul Semiconductor © 2013 All Rights Reserved.

Company Information

Seoul Semiconductor (www.SeoulSemicon.com) manufactures and packages a wide selection of light emitting diodes (LEDs) for the automotive, general illumination/lighting, Home appliance, signage and back lighting markets. The company is the world's fifth largest LED supplier, holding more than 10,000 patents globally, while offering a wide range of LED technology and production capacity in areas such as "nPola", "Acrich", the world's first commercially produced AC LED, and "Acrich MJT - Multi-Junction Technology" a proprietary family of high-voltage LEDs.

The company's broad product portfolio includes a wide array of package and device choices such as Acrich and Acirch2, high-brightness LEDs, mid-power LEDs, side-view LEDs, and through-hole type LEDs as well as custom modules, displays, and sensors.

Legal Disclaimer

Information in this document is provided in connection with Seoul Semiconductor products. With respect to any examples or hints given herein, any typical values stated herein and/or any information regarding the application of the device, Seoul Semiconductor hereby disclaims any and all warranties and liabilities of any kind, including without limitation, warranties of non-infringement of intellectual property rights of any third party. The appearance and specifications of the product can be changed to improve the quality and/or performance without notice.