

For the electronic measurement of voltage: DC, AC, pulsed..., with galvanic separation between the primary and the secondary circuit.

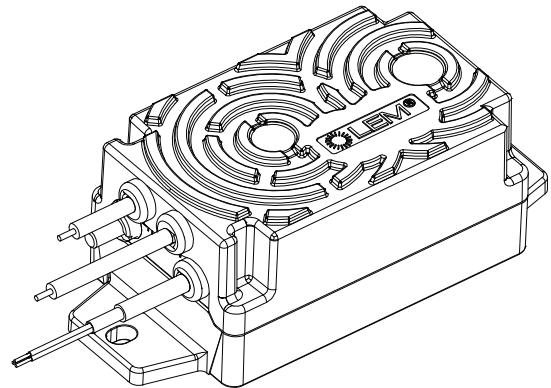

Features

- Bipolar and insulated measurement up to 1500 V
- Current output
- Compatible with AV 100 family.

Special feature

- Cables are used for primary and secondary connections.

Advantages

- Low consumption and low losses
- Compact design
- Good behavior under common mode variations
- Excellent accuracy (offset, sensitivity, linearity)
- Good response time
- Low temperature drift
- High immunity to external interferences.

Applications

- Single or three phase inverters
- Propulsion and braking choppers
- Propulsion converters
- Auxiliary converters
- High power drives
- Substations.

Standards

- EN 50155: 2007
- EN 50178: 1997
- EN 50124-1: 2001
- EN 50121-3-2: 2006
- UL 508: 2010.

Application Domains

- Traction (fixed and onboard)
- Industrial.

Absolute maximum ratings

Parameter	Symbol	Value
Maximum supply voltage ($V_P = 0\text{ V}$, 0.1 s)	$\pm U_C$	$\pm 34\text{ V}$
Maximum supply voltage (working) (- 40 .. 85 °C)	$\pm U_C$	$\pm 26.4\text{ V}$
Maximum input voltage (- 40 .. 85 °C)	V_P	1500 V
Maximum steady state input voltage (- 40 .. 85 °C)	V_{PN}	1000 V see derating on figure 2

Absolute maximum ratings apply at 25 °C unless otherwise noted.
 Stresses above these ratings may cause permanent damage.
 Exposure to absolute maximum ratings for extended periods may degrade reliability.

UL 508: Ratings and assumptions of certification

File # E189713 Volume: 2 Section: 7

Standards

- USR indicated investigation to the Standard for Industrial Control Equipment UL 508.
- CNR Indicated investigation to the Canadian standard for Industrial Control Equipment CSA C22.2 No. 14-13

Conditions of acceptability

When installed in the end-use equipment, consideration shall be given to the following:

- 1 - *These devices must be mounted in a suitable end-use enclosure.*
- 2 - *The terminal have not been evaluated for field wiring.*
- 3 - *Low voltage circuits are intended to be powered by a circuit derived from an isolating source (such as transformer, optical isolator, limiting impedance or electro-mechanical relay) and having no direct connection back to the primary circuit (other than through the grounding means).*

Marking

Only those products bearing the UL or UR Mark should be considered to be Listed or Recognized and covered under UL's Follow-Up Service. Always look for the Mark on the product.

Insulation coordination

Parameter	Symbol	Unit	Value	Comment
Rms voltage for AC insulation test, 50 Hz, 1 min	U_d	kV	8.5	100 % tested in production
Impulse withstand voltage 1.2/50 μ s	\hat{U}_w	kV	16	
Partial discharge extinction rms voltage @ 10 pC	U_e	V	2700	
Insulation resistance	R_{IS}	M Ω	200	measured at 500 V DC
Clearance (pri. - sec.)	d_{Cl}	mm	See dimensions drawing on page 9	Shortest distance through air
Creepage distance (pri. - sec.)	d_{Cp}	mm		Shortest path along device body
Case material	-	-	V0 according to UL 94	
Comparative tracking index	CTI	V	600	
Maximum DC common mode voltage	$V_{HV+} + V_{HV-}$ and $ V_{HV+} - V_{HV-} $	kV	≤ 4.2 $\leq V_{PM}$	

Environmental and mechanical characteristics

Parameter	Symbol	Unit	Min	Typ	Max
Ambient operating temperature	T_A	$^{\circ}$ C	-40		85
Ambient storage temperature	T_S	$^{\circ}$ C	-50		90
Mass	m	g		470	

Electrical data

At $T_A = 25\text{ °C}$, $\pm U_C = \pm 24\text{ V}$, $R_M = 100\ \Omega$, unless otherwise noted.

Lines with a * in the conditions column apply over the $-40 \dots 85\text{ °C}$ ambient temperature range.

Parameter	Symbol	Unit	Min	Typ	Max	Conditions
Primary nominal rms voltage	V_{PN}	V		1000		*
Primary voltage, measuring range	V_{PM}	V	-1500		1500	*
Measuring resistance	R_M	Ω	0		133	* See derating on figure 2. For $ V_{PM} < 1500\text{ V}$, max value of R_M is given on figure 1
Secondary nominal rms current	I_{SN}	mA		50		*
Secondary current	I_S	mA	-75		75	*
Supply voltage	$\pm U_C$	V	± 13.5	± 24	± 26.4	*
Rise time of U_C (10-90 %)	t_{rise}	ms			100	
Current consumption @ $U_C = \pm 24\text{ V}$ at $V_p = 0\text{ V}$	I_C	mA		20	25	
Offset current	I_O	μA	-50	0	50	100 % tested in production
Temperature variation of I_O	I_{OT}	μA	-120 -150		120 150	-25 .. 85 °C -40 .. 85 °C
Sensitivity	G	$\mu\text{A/V}$		50		50 mA for primary 1000 V
Sensitivity error	ϵ_G	%	-0.2	0	0.2	
Thermal drift of sensitivity	ϵ_{GT}	%	-0.5		0.5	*
Linearity error	ϵ_L	% of V_{PM}	-0.5		0.5	*
Overall accuracy	X_G	% of V_{PN}	-0.5 -1		0.5 -1	25 °C; 100 % tested in production -40 .. 85 °C *
Output rms current noise	I_{no}	μA		10		1 Hz to 100 kHz
Reaction time @ 10 % of V_{PN}	t_{ra}	μs		30		
Response time @ 90 % of V_{PN}	t_r	μs		50	60	0 to 1000 V step, 6 kV/ μs
Frequency bandwidth	BW	kHz		14 8 2		-3 dB -1 dB -0.1 dB
Start-up time	t_{start}	ms		190	250	*
Primary resistance	R_1	M Ω		11.3		*
Total primary power loss @ V_{PN}	P_p	W		0.09		*

Definition of typical, minimum and maximum values

Minimum and maximum values for specified limiting and safety conditions have to be understood as such as well as values shown in "typical" graphs.

On the other hand, measured values are part of a statistical distribution that can be specified by an interval with upper and lower limits and a probability for measured values to lie within this interval.

Unless otherwise stated (e.g. "100 % tested"), the LEM definition for such intervals designated with "min" and "max" is that the probability for values of samples to lie in this interval is 99.73 %.

For a normal (Gaussian) distribution, this corresponds to an interval between -3 sigma and +3 sigma. If "typical" values are not obviously mean or average values, those values are defined to delimit intervals with a probability of 68.27 %, corresponding to an interval between -sigma and +sigma for a normal distribution.

Typical, maximal and minimal values are determined during the initial characterization of a product.

Typical performance characteristics

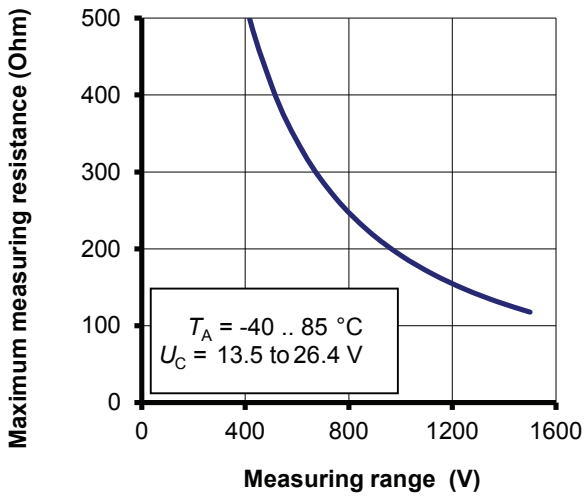

Figure 1: Maximum measuring resistance

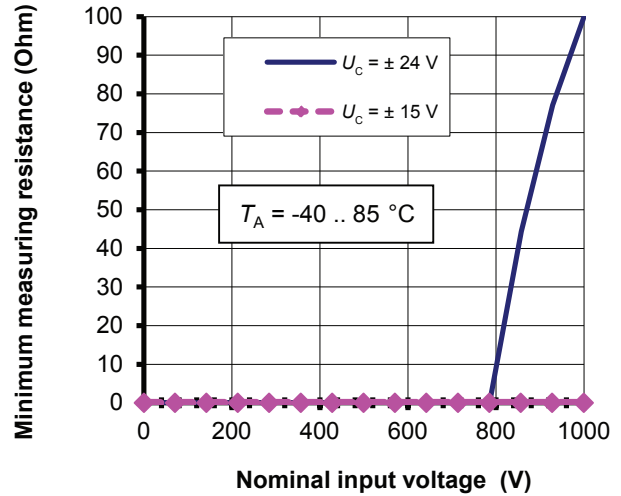

Figure 2: Minimum measuring resistance.
The derating @ ± 24 V is only applicable for $T_A = 80 \dots 85 \text{ }^\circ\text{C}$
For T_A under 80 °C, the minimum measuring resistance is 0 Ω whatever U_C

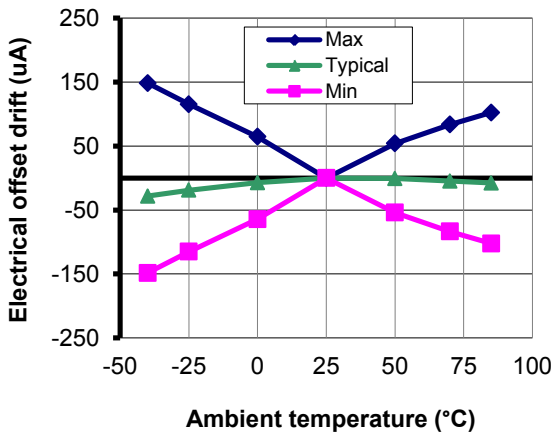

Figure 3: Electrical offset thermal drift

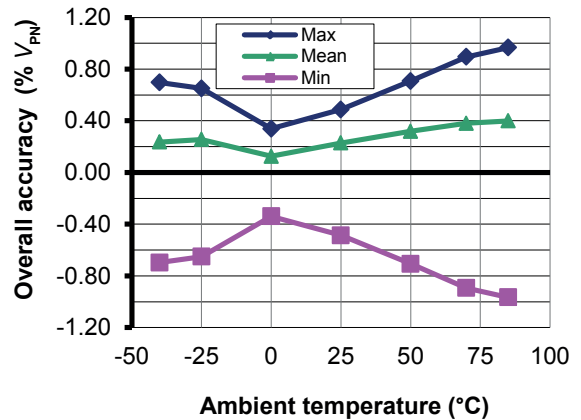

Figure 4: Overall accuracy in temperature

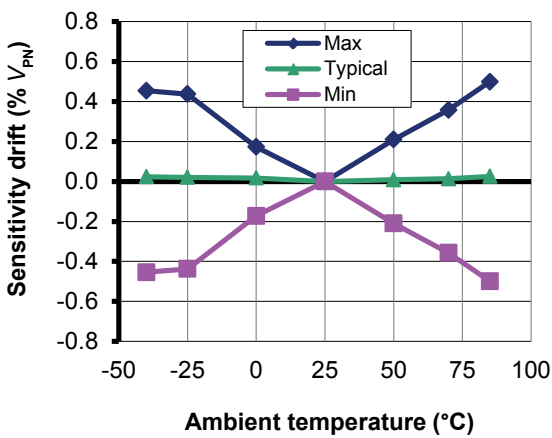

Figure 5: Sensitivity thermal drift

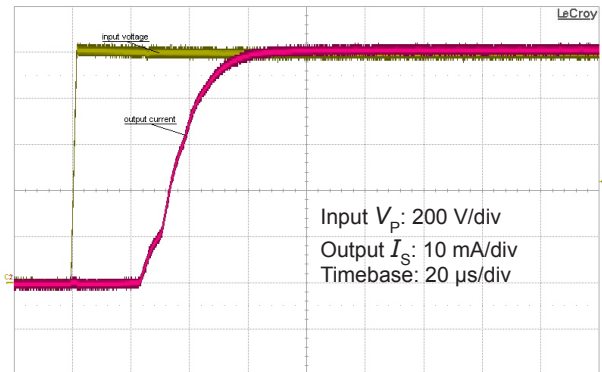

Figure 6: Typical step response (0 to 1000 V)

Typical performance characteristics (continued)

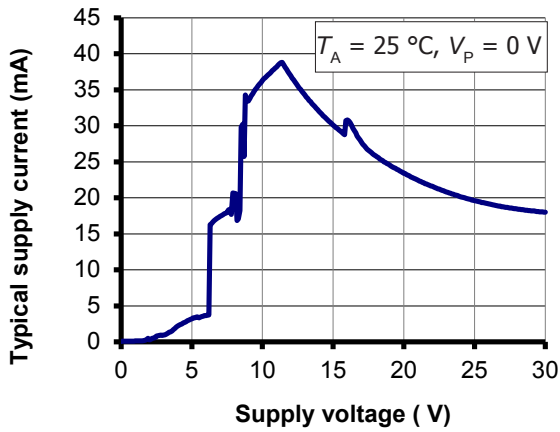

Figure 7: Supply current function of supply voltage

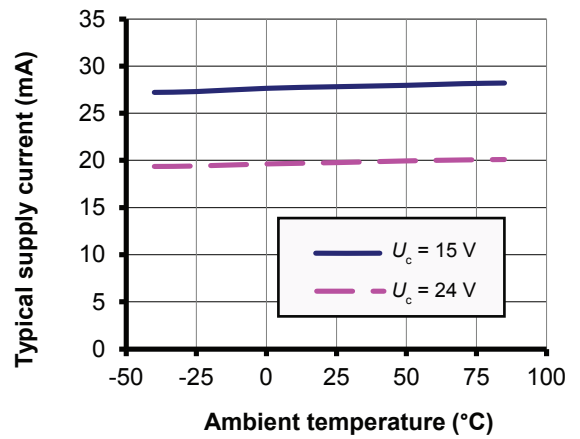

Figure 8: Supply current function of temperature

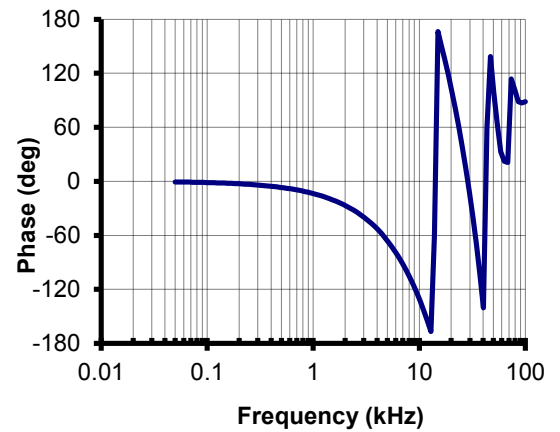
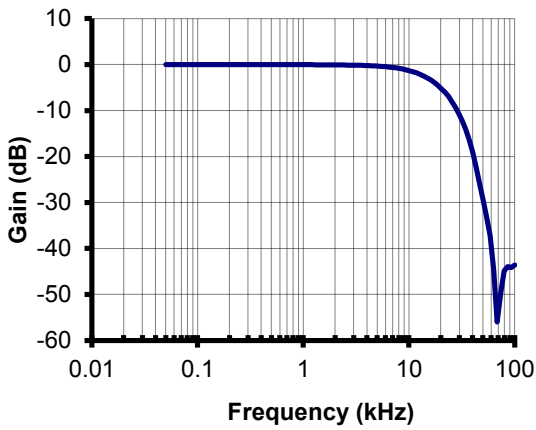

Figure 9: Typical frequency and phase response

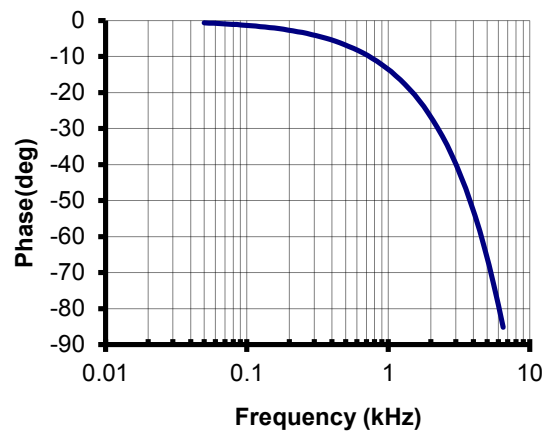
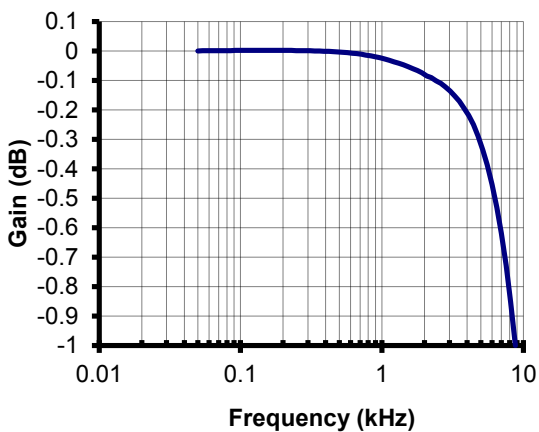

Figure 10: Typical frequency and phase response (detail)

Typical performance characteristics (continued)

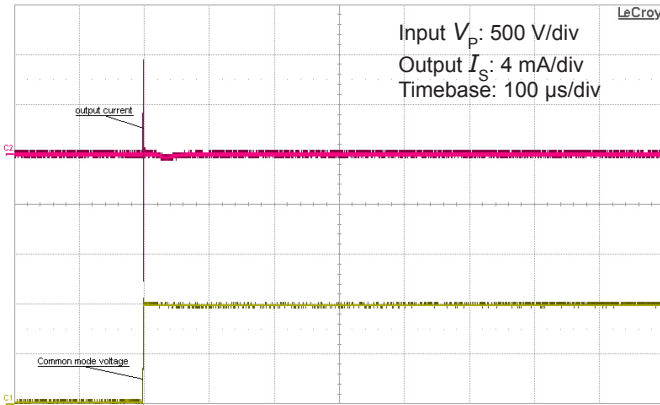

Figure 11: Typical common mode perturbation (1000 V step with 6 kV/μs $R_M = 100 \Omega$)

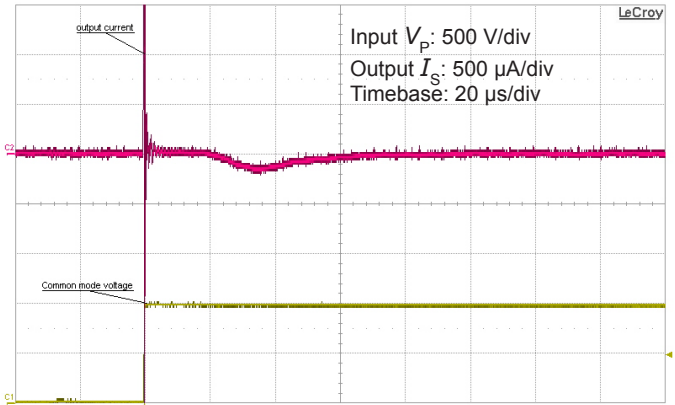

Figure 12: Detail of typical common mode perturbation (1000 V step with 6 kV/μs, $R_M = 100 \Omega$)

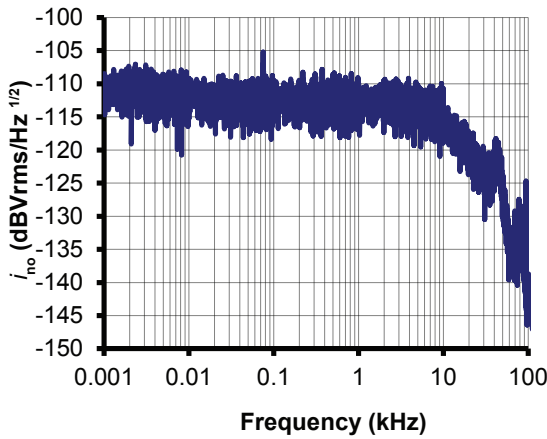

Figure 13: Typical noise current density i_{no} with $R_M = 50 \Omega$

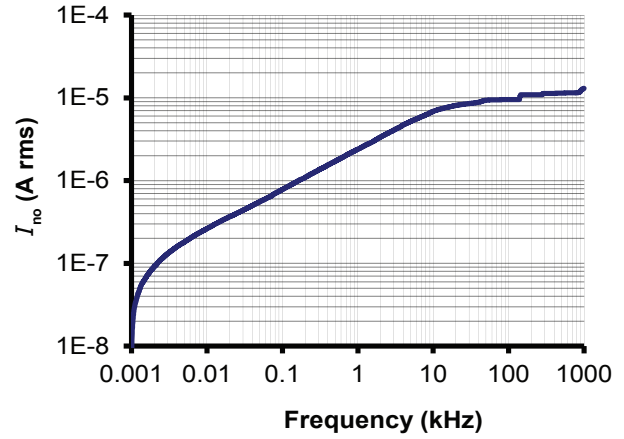

Figure 14: Typical total output rms noise current with $R_M = 50 \Omega$

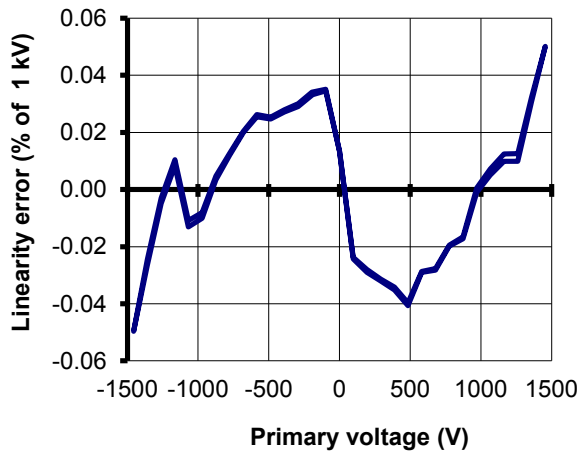

Figure 15: Typical linearity error at 25 °C

Figure 13 (noise current density) shows that there are no significant discrete frequencies in the output. Figure 14 confirms the absence of steps in the total output current noise that would indicate discrete frequencies. To calculate the noise in a frequency band $f1$ to $f2$, the formula is:

$$I_{no}(f1\text{ to }f2) = \sqrt{I_{no}(f2)^2 - I_{no}(f1)^2}$$

with $I_{no}(f)$ read from figure 14 (typical, rms value). Example:

What is the noise from 10 to 100 Hz?
Figure 14 gives $I_{no}(10 \text{ Hz}) = 0.26 \mu\text{A}$ and $I_{no}(100 \text{ Hz}) = 0.8 \mu\text{A}$. The output rms current noise is therefore.

$$\sqrt{(0.8 \cdot 10^{-6})^2 - (0.26 \cdot 10^{-6})^2} = 0.76 \mu\text{A}$$

Performance parameters definition

The schematic used to measure all electrical parameters are:

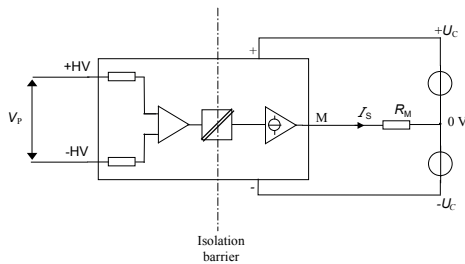

Figure 16: *standard characterization schematics for voltage output transducers ($R_M = 50 \Omega$ unless otherwise noted)*

Transducer simplified model

The static model of the transducer at temperature T_A is:

$$I_s = G \cdot V_p + \text{error}$$

In which

$$\text{error} = I_{OE} + I_{OT}(T_A) + \epsilon_G \cdot G \cdot V_p + \epsilon_{GT}(T_A) \cdot G \cdot V_p + \epsilon_L \cdot G \cdot V_{PM}$$

- I_s : secondary current (A)
- G : sensitivity of the transducer (A/V)
- V_p : primary voltage (V)
- V_{PM} : primary voltage, measuring range (V)
- T_A : ambient operating temperature ($^{\circ}\text{C}$)
- I_{OE} : electrical offset current (A)
- $I_{OT}(T_A)$: temperature variation of I_{OE} at temperature T_A (A)
- ϵ_G : sensitivity error at 25°C
- $\epsilon_{GT}(T_A)$: thermal drift of sensitivity at temperature T_A
- ϵ_L : linearity error

This is the absolute maximum error. As all errors are independent, a more realistic way to calculate the error would be to use the following formula:

$$\text{error} = \sqrt{\sum(\text{error component})^2}$$

Sensitivity and linearity

To measure sensitivity and linearity, the primary voltage (DC) is cycled from 0 to V_{PM} , then to $-V_{PM}$ and back to 0 (equally spaced $V_{PM}/10$ steps).

The sensitivity G is defined as the slope of the linear regression line for a cycle between $\pm V_{PM}$.

The linearity error ϵ_L is the maximum positive or negative difference between the measured points and the linear regression line, expressed in % of the maximum measured value.

Electrical offset

The electrical offset voltage I_{OE} is the residual output current when the input voltage is zero.

The temperature variation I_{OT} of the electrical offset current I_{OE} is the variation of the electrical offset from 25°C to the considered temperature.

Overall accuracy

The overall accuracy X_G is the error at $\pm V_{PN}$, relative to the rated value V_{PN} .

It includes all errors mentioned above.

Response and reaction times

The response time t_r and the reaction time t_{ra} are shown in the next figure.

Both depend on the primary voltage dv/dt . They are measured at nominal voltage.

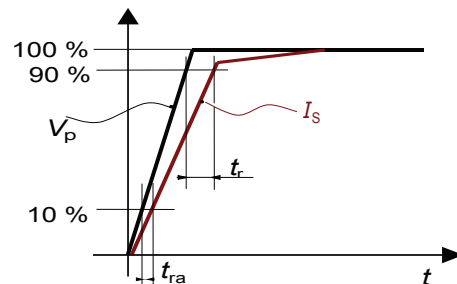
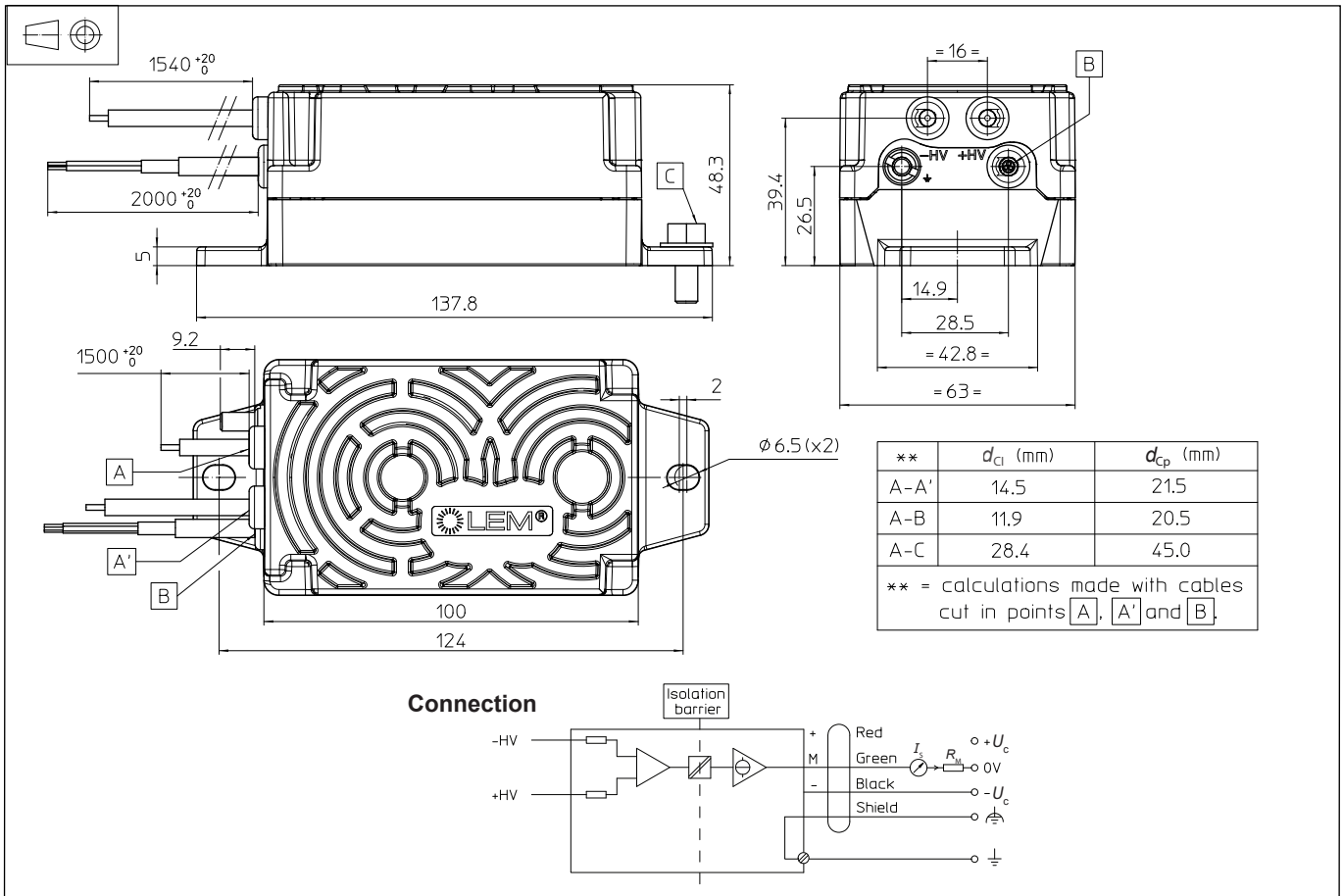
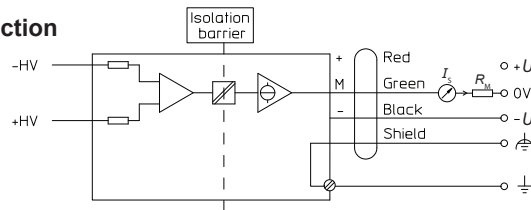

Figure 17: *response time t_r and reaction time t_{ra}*

Dimensions (in mm)

Connection

Mechanical characteristics

- General tolerance ± 1 mm
- Transducer fastening 2 holes $\varnothing 6.5$ mm
2 M6 steel screws
Recommended fastening torque 4 N·m
- Connection of primary 2 shielded cables
1.5 m 9GKW-AX 1 x 1.5 mm²
- Connection of secondary 1 shielded cable
2 m GKW-LW/S 3 x 0.5 mm²
- Earth connection M5 threaded stud
Recommended fastening torque 2.2 Nm

Remarks

- I_s is positive when a positive voltage is applied on +HV.
- The transducer is directly connected to the primary voltage.
- The primary cables have to be routed together all the way.
- The secondary cables also have to be routed together all the way.
- Installation of the transducer is to be done without primary or secondary voltage present
- Installation of the transducer must be done unless otherwise specified on the datasheet, according to LEM Transducer Generic Mounting Rules. Please refer to LEM document N°ANE120504 available on our Web site: [Products/Product Documentation](#).

Safety

This transducer must be used in electric/electronic equipment with respect to applicable standards and safety requirements in accordance with the manufacturer's operating instructions.



Caution, risk of electrical shock

When operating the transducer, certain parts of the module can carry hazardous voltage (eg. primary connections, power supply). Ignoring this warning can lead to injury and/or cause serious damage. This transducer is a build-in device, whose conducting parts must be inaccessible after installation. A protective housing or additional shield could be used. Main supply must be able to be disconnected.