



TEN PAO INTERNATIONAL LTD.

SPECIFICATION FOR APPROVAL



CUSTOMER: OZDISAN

TEN PAO
MODEL NO.: S005UV0500100

CUSTOMER P/N: _____

TEN PAO P/N: R021873V-V

CUSTOMER
MAINFRAME MODEL: _____

REV. No.: 0 a

DATE: Sep. 25, 2014

DESCRIPTION: Input:100-240Vac ;Output: 5.0Vdc 1.0A, SMPS Adaptor

Dear Customer:

Please send one copy of this specification back after you sign and approve for production

Approved By: _____

Date: _____

ISSUED BY	彭冠萍	CHECKED BY	林泽文	APPROVED BY	王萌
-----------	-----	------------	-----	-------------	----

E0-3-011 B/3

TEN PAO INTERNATIONAL LTD.

Address: Room 10-11,6/F., Kwong Sang Hong Centre, 151-153 Hoi Bun Road, Kwun Tong, Kowloon, H.K.

Tel: (852) 27905566 (5 Lines) Fax: (852) 23420146 E-mail: mkt@tenpao.com Website: <http://www.tenpao.com>

Factory Address: DongJiang Industrial Area, Shuikou Town, Huizhou City, Guangdong Province, P.R.China

Tel: 86-0752-2312888 Fax: 86-0752-2313888

Table of Contents

No.	Content	Page	
1	SCOPE		
	1.1 Description	4	
2	INPUT REQUIREMENTS		
	2.1 Input Voltage & Frequency	4	
	2.2 Input Current	4	
	2.3 Inrush Current	4	
	2.4 Stand-By Power	4	
3	OUTPUT FEATURES		
	3.1 Output Parameters	4	
	3.2 Turn On Delay	5	
	3.3 Hold Up Time	5	
	3.4 Typical Efficiency	5	
	3.5 Output Transient Response	5	
4	PROTECTION REQUIREMENT		
	4.1 Over-Voltage Protection	5	
	4.2 Over-Current Protection	5	
	4.3 Short-Circuit Protection	5	
5	ENVIRONMENTAL CONDITIONS		
	5.1 Operating	5	
	5.2 Non - Operating	5	
6	RELIABILITY AND QUALITY CONTROL		
	6.1 MTBF	6	
	6.2 Burn-In	6	
	6.3 Component Derating	6	
7	MECHANICAL CHARACTERISTICS		
	7.1 Physical Dimensions	6	
	7.2 Name Plate	6	
	7.3 Drop test	6	
8	SAFETY		
	8.1 Safety Standard	6	
	8.2 Insulation Resistance	7	
	8.3 Dielectric Strength (Hi-Pot)	7	
	8.4 Leakage Current	7	
9	EMC STANDARDS		
	9.1 EMI Standards	7	
	9.2 EMS Standards	7	
10	OTHER REQUIREMENTS		
	10.1 Hazardous Substances	8	
	10.2 Energy Efficiency	8	
11	APPENDIX		
	Appendix A	External View/Dc cord Drawing	9a,9b
	Appendix B	Circuit Diagram	10
	Appendix C	Name Plate Drawing	11
	Appendix D	Packing Drawing	12
	Appendix E	Test Report	13-16
TEN PAO P/N			
REV.			
DATE			
SHEET			
R021873V-V	0	Aug. 05,2014	Page 1 of 16

Design Revision History

Rev.	Mark	Release Date	Description of Change		Revised By	Approved By
			Before	After		
0	/	Aug. 05,2014	Creation		黄青龙	王萌
0	△ a	Sep. 25,2014	DC Cord Total length:1000	DC Cord Total length:1200	林泽文	王萌

From this line belowing is empty

--	--	--	--	--	--	--

TEN PAO P/N	REV.	DATE	SHEET
R021873V-V	0	Aug. 05,2014	Page 2 of 16

Sample Delivery Information

1. Sample Background

Circuit Diagram Revision No: 0 PCB Layout Revision No: 3 BOM Revision No: 0 Transformer Revision No.: 0

2. Sample Purpose:

A. Function Sample

B. Final sample

C. Other Sample

3. Samples material instead of information

No.	Position No	Original design materials	The sample use material	Change Reason
1	none	none	none	none
2				
3				
4				
5				

4. The Change List Compare To Last Time Samples was:

The(**First**)Samples,This Time Samples' Tracking Number was:(**A01-A05**), Delivery Date:(**Aug. 05,2014**).

No.	What is At Last Time Samples	What Is At This Time Samples	Change Reason
1	none	none	none
2			
3			
4			
5			

Remark: Not final sample cannot be used to approve

TEN PAO P/N	ISSUED BY	APPROVED BY	DATE	REV.	SHEET
R021873V-V	黄青龙	王萌	Aug. 05,2014	0	Page 3 of 16

1. SCOPE

This document details the electrical, mechanical and environmental specifications of a switching power supply.

1.1 Description

Wall Mount

Desk-Top

Open Frame

Others

2. INPUT REQUIREMENTS

2.1 Input Voltage & Frequency

The range of input voltage is from 90Vac to 264Vac

	Min.	Normal	Max.
Input Voltage	90Vac	100-240Vac	264Vac
Input Frequency	47Hz	50/60Hz	63Hz

2.2 Input Current

The maximum input current is 150mA max. at 100-240Vac.

2.3 Inrush Current

The inrush current will not exceed 27A at 100-240Vac input and Max load for a cold start at 25°C.

2.4 Stand-By Power

The input power should be less than with No-Load.

3. OUTPUT FEATURES

3.1 Output Parameters

	Output Data	Spec. Limit			Test Condition
		Min. Value	Typical	Max. Value	
3.1.1	5.0Vdc				
3.1.2	Output Voltage	4.75Vdc	5.0Vdc	5.25Vdc	0 ~ 1.0A Loading
3.1.3	Output Load	0.0A	—	1.0A	
3.1.4	Ripple and Noise	—	—	200mVp-p	20MHz Bandwidth 10uF Ele. Cap.0.1uF Cer. Cap.
3.1.5	Output Overshoot	—	—	10%	MAX. load(1.0A) & 100-240Vac

TEN PAO P/N	REV.	DATE	SHEET
R021873V-V	0	Aug. 05,2014	Page 4 of 16

3.2 Turn On Delay

During turn on and turn off, no output voltage shall exceed its nominal voltage by more than **10%** and no output shall change its polarity with respect to its return line. All outputs shall reach their steady state values within **3** seconds of turn on.

3.3 Hold Up Time

10 ms minimum at **115Vac/60Hz** input at maximum load, and **20** ms minimum at **230Vac/50Hz** input at maximum load.

3.4 Typical Efficiency

The efficiency (watts out / watts in) shall be higher than typical while measuring at nominal line and maximum load condition, test in 1 minute after power on.

3.5 Output Transient Response

The power supply shall maintain output transient response time within **10ms** with a loading current change from 20% to 80% of maximum current and 0.5A/μs rise up /drop down test at end of output terminal.

4. PROTECTION REQUIREMENT

4.1 Over-Voltage Protection

Over-voltage protection shall be included in the adaptor circuit. A single component failure must not cause an over voltage.

4.2 Over-Current Protection

The adaptor must have a current limiting function on the output voltage. in overload mode, the output must drop to a low voltage.

4.3 Short-Circuit Protection

The adaptor must withstand a continuous short circuit on the output without damage.

5. ENVIRONMENTAL CONDITIONS

5.1 Operating

The power supply shall be capable of operating normally in any mode without malfunction happens in the following environmental conditions.

5.1.1 Operating Temperature: 0°C ~45°C (Can operate normally)

Relative Humidity: 10% ~ 90%

Altitude: Sea level to 2,000 m.

5.1.2 Vibration: 1.0mm, 10 –55Hz, 15 minutes per cycle for each axis (X, Y, Z).

5.1.3 Cooling: Natural convection cooling

5.2 Non - Operating

The power supply shall be capable of withstanding the following environmental conditions extended periods of time, without sustaining electrical or mechanical damage and subsequent operational deficiencies.

TEN PAO P/N	REV.	DATE	SHEET
R021873V-V	0	Aug. 05,2014	Page 5 of 16

5.2.1 Storage Temperature: -30°C ~ 70°C

5.2.2 Relative Humidity: 10% ~ 90%

5.2.3 Altitude: Sea level to 2,000 m.

5.2.4 Vibration and Shock:

The power supply shall be designed to withstand normal transportation vibration per MIL-STD-810D, method 514 and procedures X, as it is mounted in the chassis assembly and packed for shipping.

6. RELIABILITY AND QUALITY CONTROL

6.1 MTBF

When the power supply is operating within the limits of this specification the MTBF shall be at least 50,000 hours at 25°C (MIL-HDBK-217F).

6.2 Burn-In

The power supply shall withstand a minimum of 4 hours Burn-In test under full load at 35°C ~40°C room temperatures, after test, product shall operate normally.

6.3 Component Derating

Semiconductor junction temperatures shall not exceed the manufacturer's maximum thermal rating.

7. MECHANICAL CHARACTERISTICS

7.1 Physical Dimensions

The detail dimension of the power supply is drawn on APPENDIX A.

7.2 Nameplate

The label of the power supply, please see APPENDIX C.

7.3 Drop test

Dropped freely from 1 m (for wall mount product) height onto the surface is consisted of hardwood 13 mm thick, mounted on two layers of plywood each 19-20 mm thick, all supported on concrete floor 1 time from 3 different surface, after test, it's no safety damage for product.

8. SAFETY

8.1 Safety Standard

The power supply shall be certified under the following international regulatory standards

TEN PAO P/N	REV.	DATE	SHEET
R021873V-V	0	Aug. 05,2014	Page 6 of 16

Item	Country	Certified	Standard
GS	Europe	Approved	EN60950-1
CE	Europe	Approved	EN60950-1

8.2 Insulation Resistance

Input to output: 10 MΩ min. at 500 VDC.

8.3 Dielectric Strength (Hi-Pot)

Primary to Secondary **DC4242V,3.5mA** 1 minute for type test,

DC4500V,3.5mA 2 seconds for product.

8.4 Leakage Current

The leakage current shall be less than **0.25mA** for **Class II** when the power supply is operated maximum input voltage and maximum frequency.

9. EMC STANDARDS

9.1 EMI Standards

The power supply shall meet the radiated and conducted emission requirements for **EN55022.**

9.2 EMS Standards(**EN55024**)

The power supply shall meet the following EMS standards

9.2.1 IEC61000-4-2 Electrostatic Discharge (ESD)

Static – discharge test by **contact** or air should be conducted with Static – discharge **tester**, energy storage capacitance of 150pF, and discharge resistance of 330Ω.

8KV air discharge, **4KV** contact discharge, Performance Criterion B.

9.2.2 IEC61000-4-3 Radiated Electromagnetic Fields(RS)

Radio- frequency Electromagnetic Field Susceptibility Test, RS, 80-1000MHz,3V/m, 80%AM(1KHz), Performance Criterion A.

9.2.3 IEC61000-4-4 Electrical Fast Transient / Burst (EFT)

Power Line to Line: **1KV**

Performance Criterion B.

TEN PAO P/N	REV.	DATE	SHEET
R021873V-V	0	Aug. 05,2014	Page 7 of 16

9.2.4 IEC61000-4-5 Lightning Surge Attachment

Lightning Surge voltage of differential and common modes shall be applied across AC input lines and across input and frame ground.

Power Line to Line: **1KV**

Performance Criterion B.

9.2.5 IEC61000-4-6 Conducted Radio Frequency Disturbances (CS)

Conducted Radio Frequency Disturbances Test, CS, 0.15-80 MHz, 3V/m, 80%AM, 1KHz, Performance Criterion A.

9.2.6 IEC61000-4-11 Voltage Dips/Short Interruption/Variations

Voltage Dips, 30% reduction- 10ms, Performance Criterion B, 60% Reduction – 100ms, Performance Criterion C, Voltage Interruptions>95% Reduction- 5000ms, Performance Criterion C.

10. OTHER REQUIREMENTS

10.1 Hazardous Substances

The components and used materials shall be in compliance with

EU Directive [2011/65/EU](#) "RoHS"

EU Directive [2012/19/EU](#) "WEEE"

Halogen Free

REACH

10.2 Energy Efficiency

10.2.1 The No-Load power consumption shall be less than **0.3W** at input **115/230Vac,60/50Hz.**

10.2.2 The average active mode efficiency shall be higher than **68.17%** at input **115/230Vac,60/50Hz.**

10.2.3 International Efficiency Level V .

Korea Energy Efficiency Label

10.2.4 This power supply is therefore in compliance with the requirements of

California Energy Commission Energy Efficiency requirements for external power supplies (CEC)

Energy Star Energy Efficiency requirements for external power supplies (EPS Version 2.0)

[Canada's Energy Efficiency Regulations for External Power Supplies](#)

Australian and New Zealand Energy Performance Requirements for external power supplies (MEPS,AS/NZS 4665.1,AS/NZS 4665.2)

China Energy Efficiency requirements for external power supplies (GB20943)

Korea regulation on Energy Efficiency Labeling and Standards for external power supplies (MKE's Notification 2008-99)

Implementing Directive [2009/125/EC](#) of the European Parliament and of the Council with regard to ecodesign requirements for no-load condition electric power consumption and average active efficiency of external power supplies (**No 278/2009 ,Stage 2**)

TEN PAO P/N	REV.	DATE	SHEET
R021873V-V	0	Aug. 05,2014	Page 8 of 16

APPENDIX A

Mechanical Dimensions(Unit: mm) Tolerance Of Unspecified Parts:±1.5mm

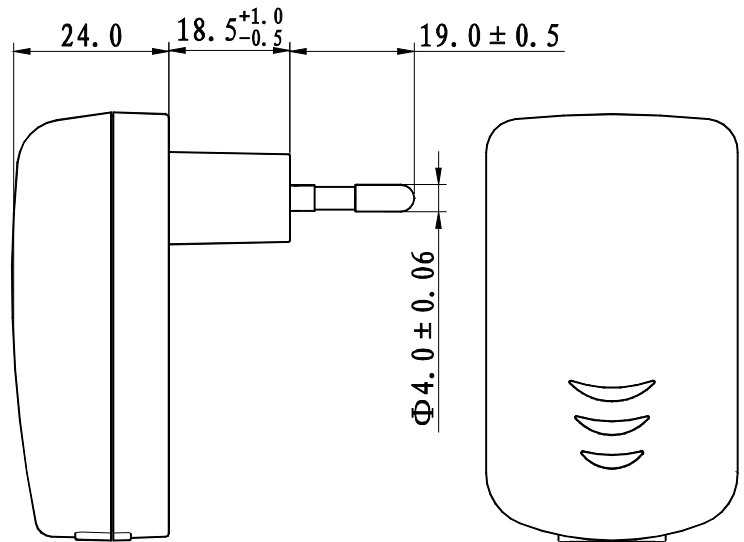
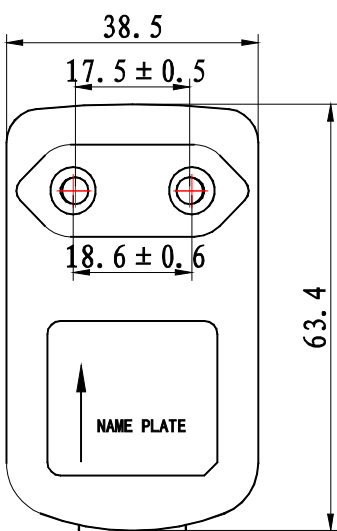
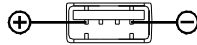
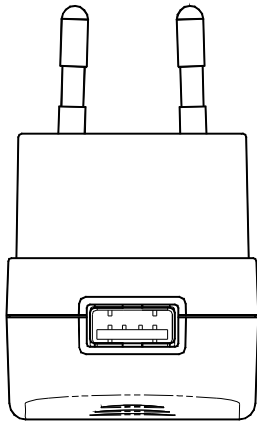

REMARK	COLOR: BLACK
--------	--

TEN PAO P/N	REV.	DATE	SHEET
R021873V-V	0	Aug. 05,2014	Page 9a of 16

APPENDIX A

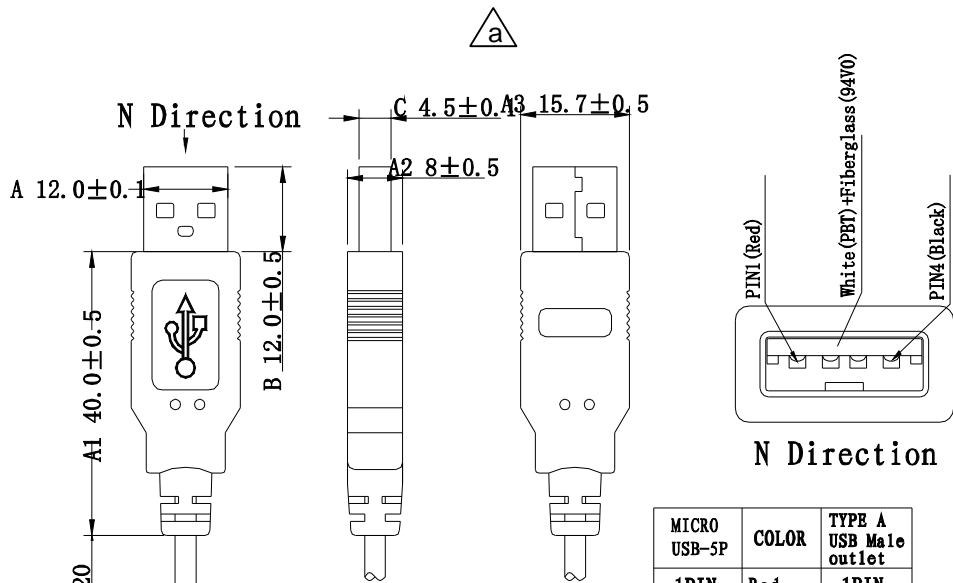

MICRO USB-5P	COLOR	TYPE A USB Male outlet
1PIN	Red	1PIN
2PIN	Empty	2PIN
3PIN	PIN	3PIN
4PIN	PIN	4PIN
5PIN	Black	5PIN

Connecting method

Technical requirement:

1. Unit: mm
2. Tolerance of unspecified parts: ± 0.3
3. 20#/2C UL2725 black wire cover with plastic and with 4PIN USB A male plug, matches the tail like the shape of PL370 plug, 5PIN MICROUSB.
4. Wire connecting method see image
5. Total length: 1200 +50/0

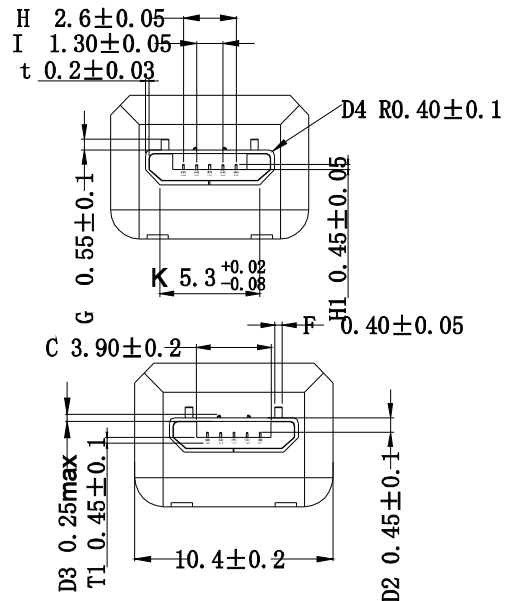
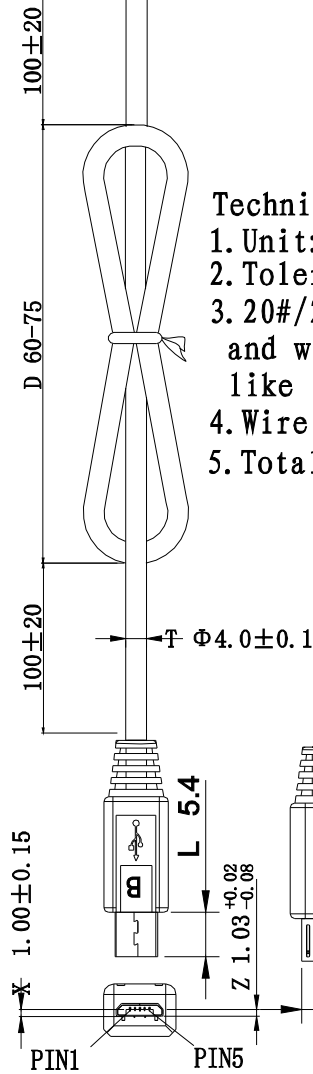

TEN PAO P/N	REV.	DATE	SHEET
R021873V-V	0	Aug. 05,2014	Page 9b of 16

APPENDIX B

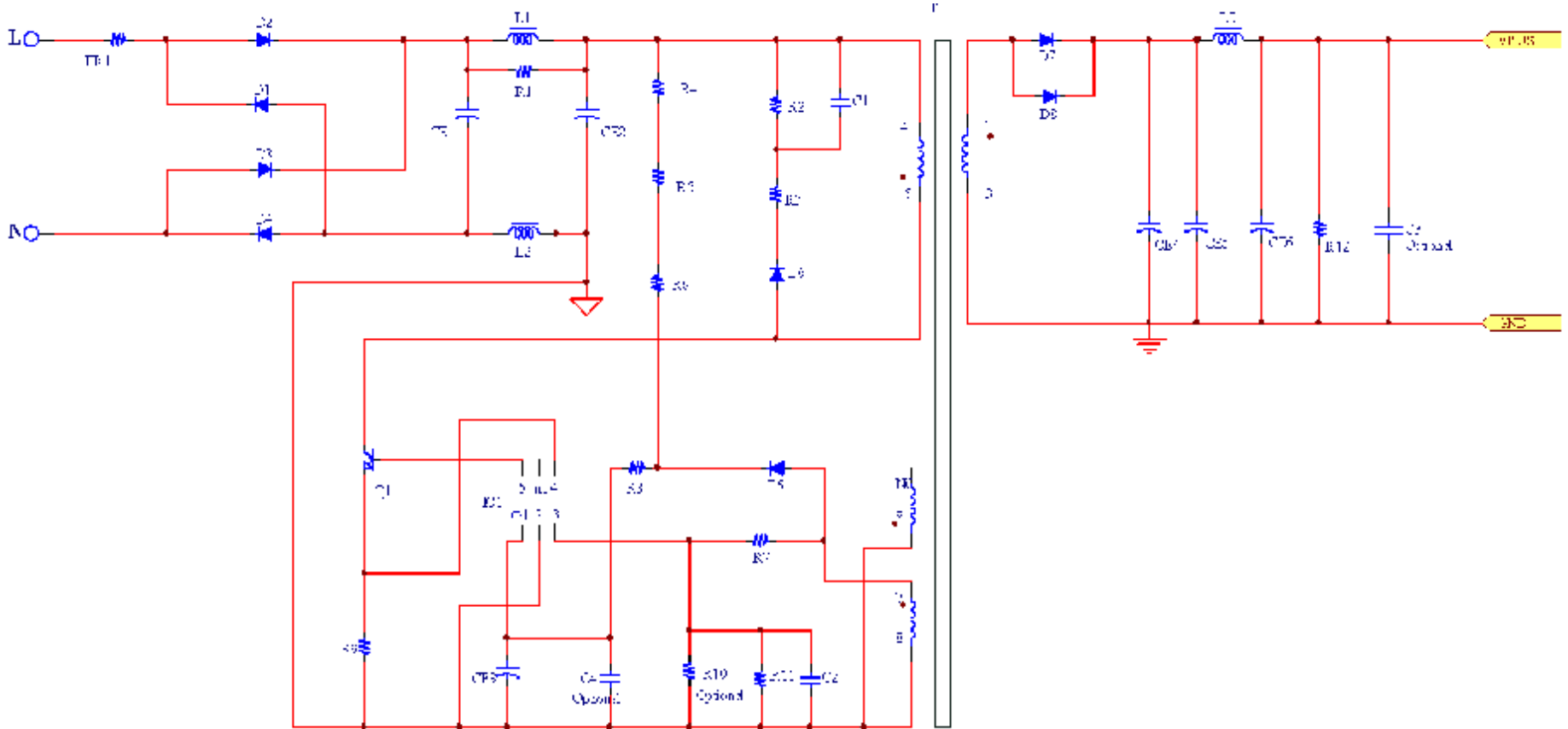

CIRCUIT DIAGRAM	DATE	Aug. 05,2014	REV.	0
	DESIGN	黄青龙	APPROVE	

TEN PAO P/N	REV.	DATE	SHEET
R021873V-V	0	Aug. 05,2014	Page 10 of 16

APPENDIX C

Name Plate:

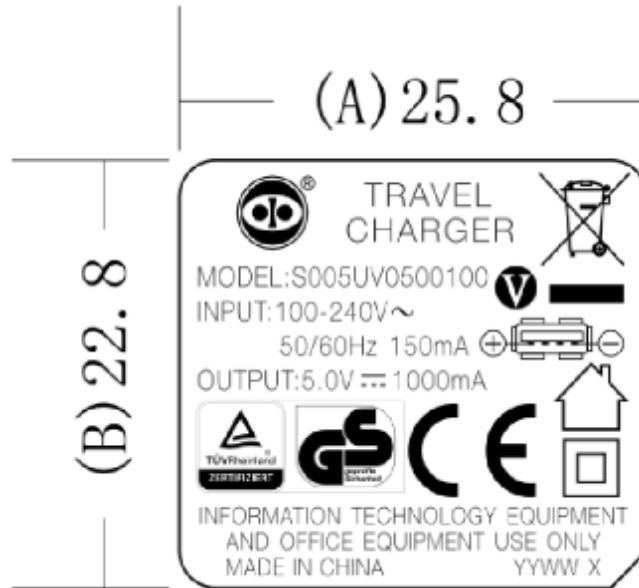

DATE CODE:

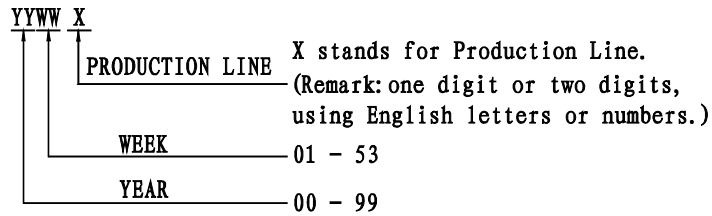

Unit: mm

Word Color: **Grey (Laser Print)**

* Please Advise If Any Comments About The Name Plate Information.
 Otherwise, This Information Is Defaulted As Customer Approval,
 And Will Be Applied To Production .

TEN PAO P/N	REV.	DATE	SHEET
R021873V-V	0	Aug. 05,2014	Page 11 of 16

APPENDIX D

PRODUCT:

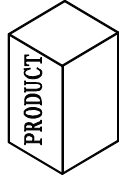

PLASTIC BAG:

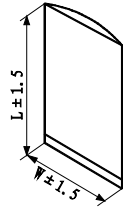

CARDBOARD:

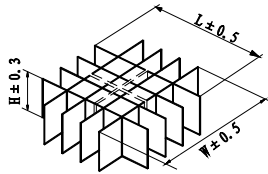

PAPERBOARD:

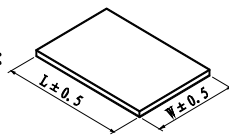

CARTON:

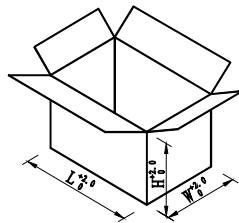

DIMENSION(UNIT IN cm):

	L	W	H
PLASTIC BAG	18.0	12.0	
CARDBOARD	47.5	37.0	4.2
PAPERBOARD	48.0	38.0	
CARTON	49.0	39.0	21.0

PACKING METHOD:

PAPERBOARD PLACEMENT METHOD	PUT A PAPERBOARD OVER AND UNDER THE PRODUCTS OF EACH LAYER, TOTAL 5PCS.
PACKING METHOD	25PCS/LAYER X 4 LAYERS
QTY	100PCS
N.W./PC	73.5g
G.W./CARTON	8.9Kg

REMARK:

1. STORAGE CONDITION

TEMPERATURE: -10°C ~ +60°C

RELATIVE HUMIDITY: 30% ~ 80%

2. STORAGE PERIOD: 6 MONTHES

3. ANLISTATIG: NO REQUIREMENT

4. PLEASE ADVISE IF ANY COMMENTS ABOUT THE PACKING INFORMATION.

OTHERWISE, THIS INFORMATION IS DEFAULTED AS CUSTOMER APPROVAL,
AND WILL BE APPLIED TO PRODUCTION.

TEN PAO P/N	REV.	DATE	SHEET
R021873V-V	0	Aug. 05,2014	Page 12 of 16

APPENDIX E

SAMPLE PRIMARY TEST REPORT

CUSTOMER		OZDISAN											
MODEL NO.		S005UV0500100				TEN PAO P/N				R021873V-V			
Test Items.	Test Condition	Unit	Sample Number and Test Result										Pass/Fail
			1#	2#	3#	4#	5#						
Unload output voltage/ (0.0A) 4.75Vdc - 5.25Vdc	90Vac	V	4.85	4.99	4.99	4.97	4.97						Pass
	132Vac	V	4.89	4.96	4.99	4.86	4.97						Pass
	180Vac	V	4.97	4.98	4.85	4.89	4.93						Pass
	264Vac	V	4.96	4.99	4.99	4.99	4.98						Pass
Unload output voltage/ (1.0A) 4.75Vdc - 5.25Vdc	90Vac	V	5.01	5.06	5.06	4.98	4.96						Pass
	132Vac	V	5.03	5.04	5.02	4.99	4.98						Pass
	180Vac	V	5.06	5.03	4.98	4.97	4.98						Pass
	264Vac	V	5.04	5.03	4.99	4.98	4.96						Pass
Output ripple & noise voltage ≤ 200mV (test at full loading)	90Vac	mV	110	113	112	110	117						Pass
	132Vac	mV	106	118	114	110	112						Pass
	180Vac	mV	109	106	106	115	106						Pass
	264Vac	mV	108	107	109	106	106						Pass
Short-circuit protection test (Short at end of DC plug)	90Vac	W	0.17	0.13	0.15	0.11	0.19						-
	264Vac	W	0.56	0.52	0.58	0.54	0.57						-
Over current protection (Ocp≤--A)	90Vac	A	1.15	1.16	1.16	1.14	1.15						Pass
	264Vac	A	1.13	1.15	1.15	1.14	1.14						Pass
Hi-pot test	4242Vdc/3.5mA/ 1Minute		OK	OK	OK	OK	OK						Pass
TEST BY	CHECKED BY	APPROVED BY			DATE			REV.	SHEET				
黄青龙		王萌			Aug. 05,2014			0	Page 13 of 16				

APPENDIX E

SAMPLE TEST REPORT

CUSTOMER:		OZDISAN									
TEN PAO MODEL NO.:		S005UV0500100			TEN PAO P/N:				R021873V-V		
Items No.	Test Items	Unit	Test condition & result						Spec. Limit	Pass/Fail	
			90Vac	115Vac	132Vac	180Vac	230Vac	264Vac			
1	Unload input current	mA	1.96	1.80	1.72	1.65	1.69	1.87	-	-	
2	Unload input power	W	0.05	0.05	0.05	0.06	0.08	0.10	≤0.3W (115/230Vac)	Pass	
3	Rated load input current	mA	130.54	107.28	97.77	81.23	69.83	63.91	≤150mA (100 - 240Vac)	Pass	
4	Rated load input power	W	7.21	6.99	6.93	6.88	6.91	6.97	-	-	
5	Unload output voltage(0.0A)	V	5.03	5.04	5.03	5.04	5.03	5.03	4.75V -5.25V	Pass	
6	Rated load output voltage(1.0A)	V	5.07	5.05	5.05	5.05	5.05	5.06	4.75V -5.25V	Pass	
7	Output ripple&noise voltage(1.0A)	mV	110.0	112.0	100.0	112.0	106.0	107.0	≤200mVp-p	Pass	
8	Short-circuit test (Pin&lout)	W	0.34	0.47	0.58	0.63	0.55	0.48	-	-	
		A	hiccup	hiccup	hiccup	hiccup	hiccup	hiccup	-	-	
9	Over current protection	A	1.16	1.15	1.15	1.15	1.15	1.15	-	-	
10	Over voltage protection	V	5.70	5.70	5.70	5.70	5.70	5.70	-	-	
11	Turn on delay time	mS	1367.0	1246.0	1109.0	978.0	916.0	864.0	-	-	
12	Hold up time	mS	13.40	17.50	34.60	62.40	91.65	120.80	≥10mS/(115Vac) ≥20mS/(230Vac)	Pass	
13	Efficiency(Full load)	%	70.32%	72.25%	72.87%	73.40%	73.08%	72.60%	-	-	
14	Mech. Dimension	mm	63.4			38.5			L:63.4±1.5; W:38.5±1.5		Pass
			24.0			-			H:24.0±1.5		Pass
			19.0			-			AC PIN:19.0±0.5		Pass
15	Hi-pot test	Pri. to Sec4242Vdc,1Minute, Cut off current≤3.5mA(Test result: 0.03mA)								Pass	
16	Drop test	Drop test 3 Times (High: 1000mm), The sample OK									
17	Max. and Light load change test	Max. load to Light load: OK Light load to max. load: OK (90-264Vac)									
18	Appe. label and fusion	Appearance: OK, Label: OK, Fusion: OK									
19	Mosfet(IC)/Vcb(normal:95% ,other:100%)	V	654.0	652.0	514.0	518.0	652.0	Mosfet spec. 800V	Derating≤95% &100% Max. Volt.	Pass	
			normal	start up	short	ocp	max/min				
20	Diode /Vrr(normal:90% ,other:100%)	V	30.9	30.8	25.3	24.7	30.2	Diode spec. 40V	Derating≤90% &100% Max. Volt.	Pass	
			normal	start up	short	ocp	max/min				
TEST BY		CHECKED BY		APPROVED BY		DATE		REV		SHEET	
黄青龙				王萌		Aug. 05,2014		0		Page 14 of 16	

APPENDIX E

SAMPLE TEST REPORT

CUSTOMER:	OZDISAN		
TEN PAO MODEL NO.:	S005UV0500100	TEN PAO P/N:	R021873V-V

1.TEST STANDARD: Implementing Directive [2009/125/EC](#) of the European Parliament and of the Council

2. Product Specification:

Input voltage, frequency, current: 100-240VAC 50/60HZ 150mA Output voltage, current: 5.0VDC/1.0A

3.TEST METHOD:

3.1. Under input 230VAC / 50Hz, output normal load, the EUT continuous operating for 30 minutes.

3.2. Under input 115VAC / 60Hz and 230VAC / 50Hz, the EUT is measured at 100%, 75%, 50% and 25% of rated output current. Record values are output voltage, output current, input power, input current. Then calculating average efficiency at four active mode load conditions.

3.3. Input 115VAC / 60Hz and 230VAC / 50Hz, test the input power, input current, output voltage in the no-load condition.

4.TEST DATA: (Room temperature: 25-30°C, relative humidity : 10-90%).

4.1 Input voltage, frequency 115V,60Hz:

Sample No.	Item	Unload	25%*I _L	50%*I _L	75%*I _L	100%*I _L	Average	
1#	Output	Current(mA)	0	250	500	750	1000	/
		Voltage(V)	5.07	5.08	5.08	5.09	5.03	/
		Power(W)	/	/	/	/	/	/
	Input	Power(W)	0.05	1.7	3.36	5.16	7.1	/
		THD _V (%)	/	/	/	/	/	/
		True PF	0.234	0.436	0.488	0.528	0.560	/
		Current(mA)	1.79	33.53	59.35	84.12	108.95	/
	Efficiency(%)		/	74.71%	75.60%	73.98%	70.85%	73.78%
2#	Output	Current(mA)	0	250	500	750	1000	/
		Voltage(V)	5.04	5.03	5.04	5.06	5.09	/
		Power(W)	/	/	/	/	/	/
	Input	Power(W)	0.05	1.69	3.35	5.14	7.06	/
		THD _V (%)	/	/	/	/	/	/
		True PF	0.234	0.434	0.485	0.525	0.557	/
		Current(mA)	0	33.58	59.44	84.24	109.00	/
	Efficiency(%)		/	74.41%	75.22%	73.83%	72.10%	73.89%
3#	Output	Current(mA)	0	250	500	750	1000	/
		Voltage(V)	5.04	5.05	5.02	5.01	5.03	/
		Power(W)	/	/	/	/	/	/
	Input	Power(W)	0.05	1.7	3.37	5.15	7.07	/
		THD _V (%)	/	/	/	/	/	/
		True PF	0.235	0.438	0.489	0.528	0.560	/
		Current(mA)	1.8	33.42	59.22	83.88	108.60	/
	Efficiency(%)		/	74.26%	74.48%	72.96%	71.15%	73.21%
Energy Efficiency (Min.) : 73.21%		Efficient Level : 68.17%			JUDGEMENT	Pass/Fail	Pass	

TEST BY	CHECKED BY	APPROVED BY	DATE	REV.	0
黄青龙		王萌	Aug. 05,2014	0	Page 15 of 16

APPENDIX E

SAMPLE TEST REPORT

CUSTOMER:	OZDISAN		
TEN PAO MODEL NO.:	S005UV0500100	TEN PAO P/N:	R021873V-V

4.2 Input voltage, frequency 230V,50Hz:

Sample No.	Item	Unload	25%*I _L	50%*I _L	75%*I _L	100%*I _L	Average	
1#	Output	Current(mA)	0	250	500	750	1000	/
		Voltage(V)	5.05	4.99	5.03	5.08	5.09	/
		Power(W)	/	/	/	/	/	/
	Input	Power(W)	0.08	1.74	3.44	5.17	7.00	/
		THD _V (%)	/	/	/	/	/	/
		True PF	0.195	0.344	0.374	0.405	0.424	/
		Current(mA)	1.72	21.71	39.58	55.03	71.17	/
Efficiency(%)		/	71.70%	73.11%	73.69%	72.71%	72.80%	
2#	Output	Current(mA)	0	250	500	750	1000	/
		Voltage(V)	5.08	4.99	5.03	5.06	5.09	/
		Power(W)	/	/	/	/	/	/
	Input	Power(W)	0.08	1.73	3.43	5.17	7.00	/
		THD _V (%)	/	/	/	/	/	/
		True PF	0.195	0.345	0.375	0.405	0.424	/
		Current(mA)	1.72	21.61	39.36	54.88	70.90	/
Efficiency(%)		/	72.11%	73.32%	73.40%	72.71%	72.89%	
3#	Output	Current(mA)	0	250	500	750	1000	/
		Voltage(V)	5.07	4.990	5.020	5.050	5.070	/
		Power(W)	/	/	/	/	/	/
	Input	Power(W)	0.08	1.74	3.45	5.18	7.00	/
		THD _V (%)	/	/	/	/	/	/
		True PF	0.195	0.347	0.378	0.409	0.427	/
		Current(mA)	1.68	21.63	39.24	54.57	70.63	/
Efficiency(%)		/	71.70%	72.75%	73.12%	72.43%	72.50%	

Energy Efficiency (Min.) :72.50%	Efficient Level : 68.17%	JUDGEMENT	Pass/Fail	Pass
----------------------------------	--------------------------	-----------	-----------	------

5.EQUIPMENTS LIST:

Power meter: WT210 AC source: AFC-500W Electronic load: Prodigit 3311F

6.REMARK:

First Function Sample

TEST BY	CHECKED BY	APPROVED BY	DATE	REV.	SHEET
黄青龙		王萌	Aug. 05,2014	0	Page 16 of 16