

Standard Rectifier

$$V_{RRM} = 2 \times 800V$$

$$I_{FAV} = 8A$$

$$V_F = 1.08V$$

Phase leg

Part number

DSP8-08AS

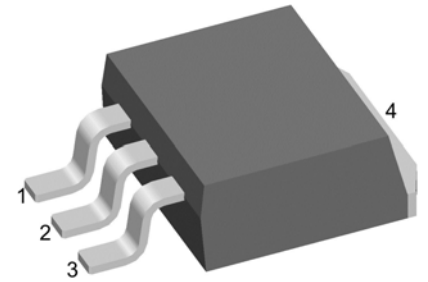

Backside: anode/cathode

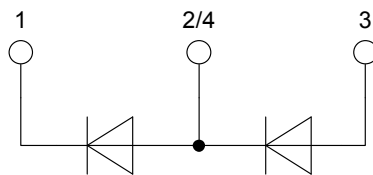

Features / Advantages:

- Planar passivated chips
- Very low leakage current
- Very low forward voltage drop
- Improved thermal behaviour

Applications:

- Diode for main rectification
- For single and three phase bridge configurations

Package: TO-263 (D2Pak)

- Industry standard outline
- RoHS compliant
- Epoxy meets UL 94V-0

Rectifier				Ratings		
Symbol	Definition	Conditions	min.	typ.	max.	Unit
V_{RSM}	max. non-repetitive reverse blocking voltage	$T_{VJ} = 25^{\circ}C$			900	V
V_{RRM}	max. repetitive reverse blocking voltage	$T_{VJ} = 25^{\circ}C$			800	V
I_R	reverse current, drain current	$V_R = 800 V$	$T_{VJ} = 25^{\circ}C$		10	μA
		$V_R = 800 V$	$T_{VJ} = 150^{\circ}C$		0.2	mA
V_F	forward voltage drop	$I_F = 8 A$	$T_{VJ} = 25^{\circ}C$		1.16	V
		$I_F = 16 A$			1.35	V
		$I_F = 8 A$	$T_{VJ} = 150^{\circ}C$		1.08	V
		$I_F = 16 A$			1.34	V
I_{FAV}	average forward current	$T_C = 160^{\circ}C$ rectangular $d = 0.5$	$T_{VJ} = 175^{\circ}C$		8	A
V_{FO}	threshold voltage	} for power loss calculation only	$T_{VJ} = 175^{\circ}C$		0.79	V
r_F	slope resistance				33	m Ω
R_{thJC}	thermal resistance junction to case				1.5	K/W
R_{thCH}	thermal resistance case to heatsink			0.25		K/W
P_{tot}	total power dissipation		$T_C = 25^{\circ}C$		100	W
I_{FSM}	max. forward surge current	$t = 10 ms; (50 Hz), sine$	$T_{VJ} = 45^{\circ}C$		120	A
		$t = 8,3 ms; (60 Hz), sine$	$V_R = 0 V$		130	A
		$t = 10 ms; (50 Hz), sine$	$T_{VJ} = 150^{\circ}C$		100	A
		$t = 8,3 ms; (60 Hz), sine$	$V_R = 0 V$		110	A
I^2t	value for fusing	$t = 10 ms; (50 Hz), sine$	$T_{VJ} = 45^{\circ}C$		72	A ² s
		$t = 8,3 ms; (60 Hz), sine$	$V_R = 0 V$		70	A ² s
		$t = 10 ms; (50 Hz), sine$	$T_{VJ} = 150^{\circ}C$		50	A ² s
		$t = 8,3 ms; (60 Hz), sine$	$V_R = 0 V$		50	A ² s
C_J	junction capacitance	$V_R = 400 V$ $f = 1 MHz$	$T_{VJ} = 25^{\circ}C$		4	pF

Package TO-263 (D2Pak)			Ratings			
Symbol	Definition	Conditions	min.	typ.	max.	Unit
I_{RMS}	RMS current	per terminal			25	A
T_{stg}	storage temperature		-55		150	°C
T_{vj}	virtual junction temperature		-55		175	°C
Weight				2		g
F_C	mounting force with clip		20		60	N

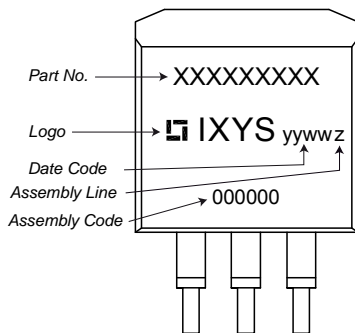
Product Marking

Ordering	Part Number	Marking on Product	Delivery Mode	Quantity	Code No.
Standard	DSP8-08AS	DSP8-08AS	Tube	50	504315

Similar Part	Package	Voltage class
DSP8-08S	TO-263AB (D2Pak) (2)	800
DSP8-08A	TO-220AB (3)	800
DSP8-12AS	TO-263AA (D2Pak) (3)	1200
DSP8-12S	TO-263AB (D2Pak) (2)	1200
DSP8-12A	TO-220AB (3)	1200
DSP8-12AC	ISOPLUS220AB (3)	1200

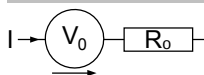
Equivalent Circuits for Simulation
** on die level*
 $T_{vj} = 175^{\circ}C$

Rectifier

$V_{0\ max}$	threshold voltage	0.79	V
$R_{0\ max}$	slope resistance *	30	mΩ

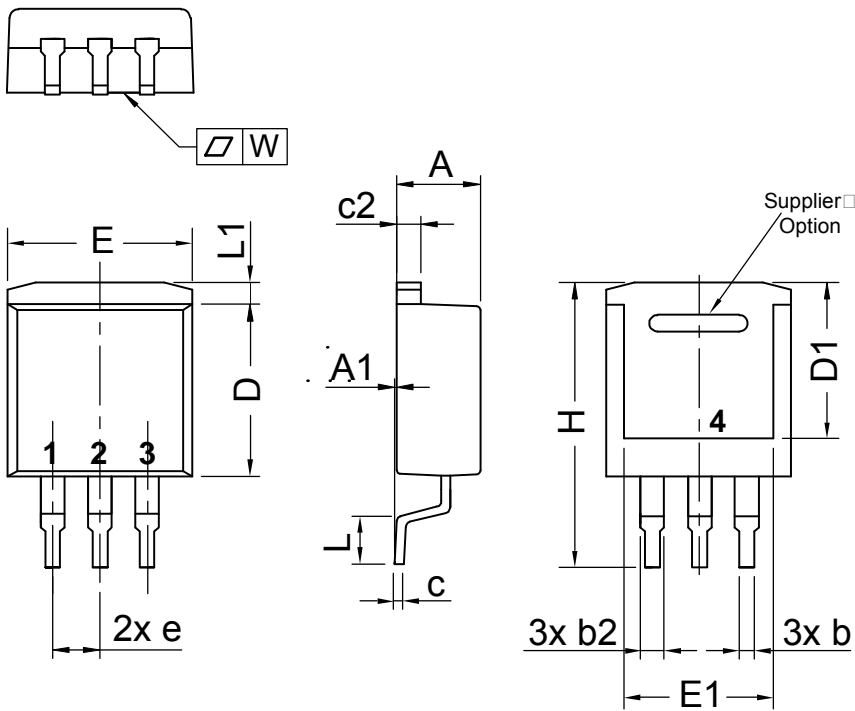
Outlines TO-263 (D2Pak)



Dim.	Millimeter		Inches	
	min	max	min	max
A	4.06	4.83	0.160	0.190
A1	typ. 0.10		typ. 0.004	
A2	2.41		0.095	
b	0.51	0.99	0.020	0.039
b2	1.14	1.40	0.045	0.055
c	0.40	0.74	0.016	0.029
c2	1.14	1.40	0.045	0.055
D	8.38	9.40	0.330	0.370
D1	8.00	8.89	0.315	0.350
D2	2.5		0.098	
E	9.65	10.41	0.380	0.410
E1	6.22	8.50	0.245	0.335
e	2,54 BSC		0,100 BSC	
e1	4.28		0.169	
H	14.61	15.88	0.575	0.625
L	1.78	2.79	0.070	0.110
L1	1.02	1.68	0.040	0.066
W	typ. 0.02	0.040	typ. 0.0008	0.002

All dimensions conform with and/or within JEDEC standard.

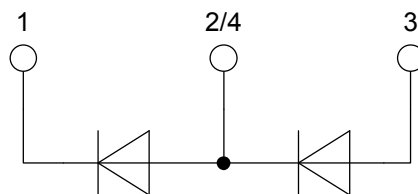

Rectifier

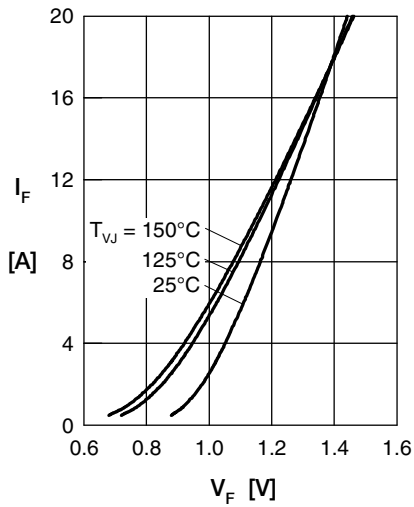

Fig. 1 Forward current versus voltage drop per diode

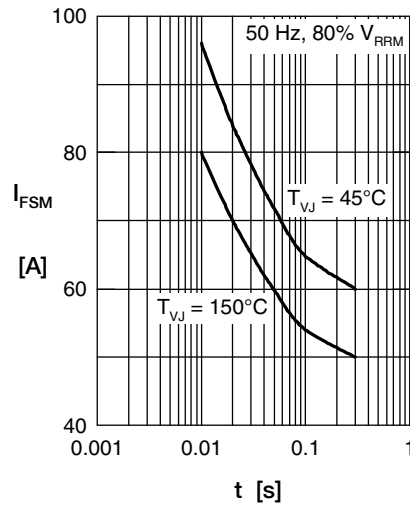

Fig. 2 Surge overload current

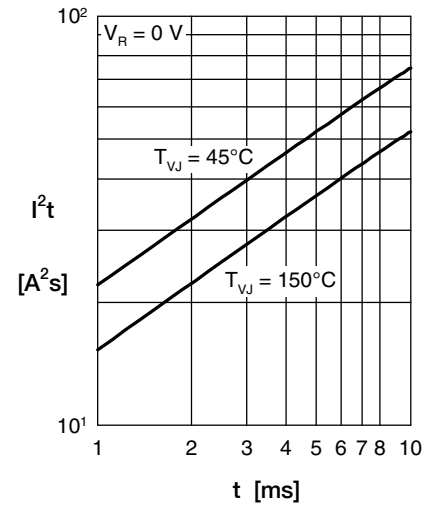

Fig. 3 I^2t versus time per diode

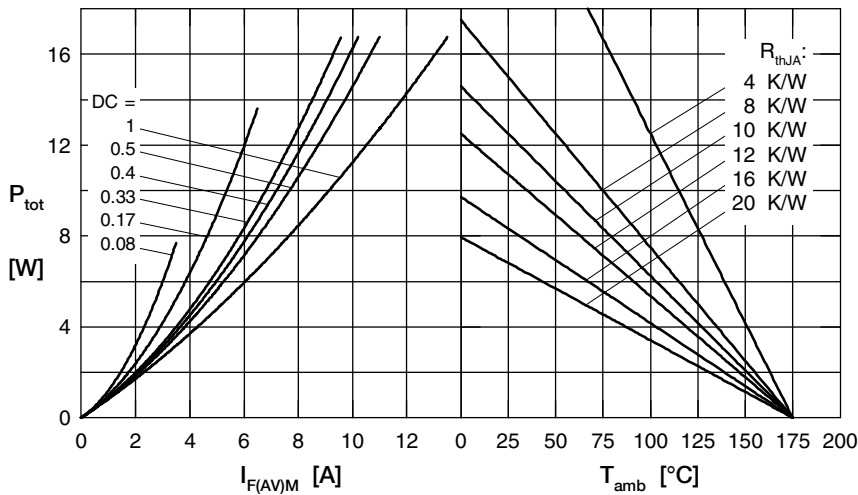

Fig. 4 Power dissipation vs. direct output current and ambient temperature

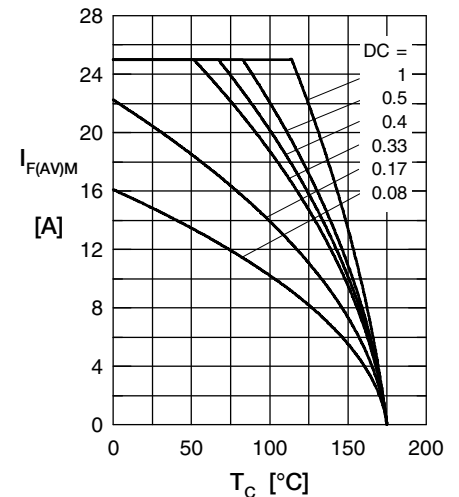

Fig. 5 Max. forward current vs. case temperature

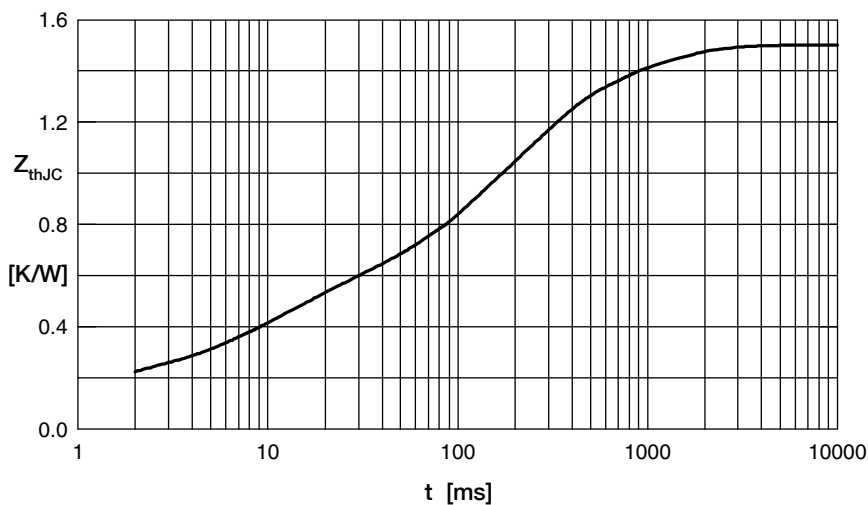

Fig. 6 Transient thermal impedance junction to case

Constants for Z_{thJC} calculation:

i	R_{thi} (K/W)	t_i (s)
1	0.155	0.0005
2	0.332	0.0095
3	0.713	0.17
4	0.3	0.8
5	0.00001	0.00001