



High Quality
Evolution
Commitment

HEC-20LTT-XXPSAS(230Vac) Rev A

A. Features

IP 20

- Efficiency (Up to 82%).
- Active Power Factor Correction (Typical 0.95).
- Isolation Class II.
- All-Round Protection: SCP/OVP/OPP.
- Fully isolated plastic case with IP20 and dry location.
- Class 2 and SELV.
- AC Phase-cut dimming work with leading edge and trailing edge TRIAC dimmers.

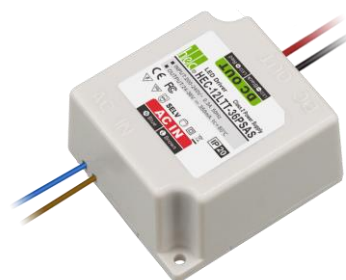

B. Description

The **HEC-20LTT-XXPSAS** Series operate from a 180 ~ 264Vac input range. They are designed to be highly reliable. Features include short circuit protection and over voltage protection.

C. Models

Output Current	Input Voltage Range Note 1	Output Voltage Range Note 4	Max. Output Power	Efficiency Note 2	Power Factor Note 2	Model Number
700mA	180 ~ 264Vac	21V~28V	20 W	82%	0.95	HEC-20LTT-28PSAS
500mA	180 ~ 264Vac	36V~42V	20 W	82%	0.95	HEC-20LTT-42PSAS
350mA	180 ~ 264Vac	36V~48V	20 W	82%	0.95	HEC-20LTT-48PSAS

D. Electronic Specifications

- Input Specifications

Parameter	Min.	Typ.	Max.	Notes
Input Voltage (V)	180	-	264	
Input Frequency (Hz)	47		63	
Input AC Current (A)	-	-	0.2	Measured at full load and 220Vac input.
Leakage Current (mA)	-	-	0.7	At 240Vac 60Hz input.
Inrush Current (A)	-	-	40	At 220Vac input 25°C Cold Start. Duration=100μs, 10%Ipk-10%Ipk.
Inrush Current (I2t)		-	0.16 A2s	
Power Factor	0.9	-	-	At 230Vac input, full load.





- Output Specifications

Parameter	Min.	Typ.	Max.	Notes
Output Current (mA)				
Io = 700 mA	651		749	
Io = 500 mA	465		535	
Io = 350 mA	325		374	
No Load Output Voltage (V)				
Io = 700 mA	----	----	35	There will be no damage or hazardous conditions occurred with no loading.
Io = 500 mA			63	
Io = 350 mA			63	
Output Ripple Voltage (V)	----	----	10% Vomax	Measured by 20 MHz bandwidth oscilloscopes and the output paralleled a 0.1uF ceramic capacitor and a 10uF electrolytic capacitor.
Output Voltage Overshoot (%)	-	-	110	At full load condition.
Line Regulation (%)	-	-	±3	
Load Regulation (%)	-	-	±5	

- General Specifications

Parameter	Min.	Typ.	Max.	Notes
Efficiency (%)				
Io = 700 mA			82	Measured at full load and 120Vac input.
Io = 500 mA			82	
Io = 350 mA			82	
MTBF (hours)	320,000	-	-	Measured at full load 50°C ambient temperature (MIL-HDBK-217F).
Life Time (hours)		100,000	-	Measured at rated input voltage with full load, Case temperature=60°C @ Tc point. See life time vs. Tc curve for the details.
Case Temperature (°C)	-	-	80	
Dimensions Millimeters(L × W × H)	63.7 × 52.7 × 28.6			
Net Weight (g)				

- Protection Functions

Parameter	Min.	Typ.	Max.	Notes
Over Voltage Protection			1.50 Vo	Hiccup mode. The power supply shall be self-recovery when the fault condition is removed.





Short Circuit Protection	No damage shall occur when any output operating in a short circuit condition. The power supply shall be self-recovery when the fault condition is removed.
--------------------------	--

- Environmental Specifications

Parameter	Min.	Typ.	Max.	Notes
Operating Temperature (°C)	-40	-	+60	Humidity: 20% RH to 80% RH; See Derating Curve for more details.
Storage Temperature (°C)	-40	-	+80	Humidity: 10% RH to 90% RH.

- Safety and EMC Compliance

Safety Category	Standard
UL/CUL	UL8750, UL1310 Class 2, CSA C22.2 NO. 223-M91 Class 2.
CE	EN 61347-1, EN61347-2-13.
EMI Standards <small>Note 6</small>	Notes
EN 55015	Conducted emission Test & Radiated emission Test.
EN 61000-3-2	Harmonic current emissions.
EN 61000-3-3	Voltage fluctuations & flicker.
FCC Part 15	FCC 47 CFR Part 15 Subpart B, ICES-003 Issue 4 ANSI C63.4-2003
EMS Standards	Notes
EN 61000-4-2	Electrostatic Discharge (ESD): 8 KV air discharge, 4 KV contact discharge.
EN 61000-4-3	Radio-Frequency Electromagnetic Field Susceptibility Test-RS.
EN 61000-4-4	Electrical Fast Transient / Burst-EFT: Level 2, Criteria A.
EN 61000-4-5	Surge Immunity Test: AC Power Line: line to line 1 KV.
EN 61000-4-6	Conducted Radio Frequency Disturbances Test-CS.
EN 61000-4-8	Power Frequency Magnetic Field Test.
EN 61000-4-11	Voltage Dips.
EN 61547	Electromagnetic Immunity Requirements Applies To Lighting Equipment.

Notes:

1. Normal input voltage range 200~240Vac.
2. Measured at input 220V with a full load.
3. All specifications are typical at 25 °C unless otherwise stated.
4. Constant current operation region is preferably 80%~100% rated output voltage. This is the suitable operation region for LED related applications, but please reconfirm special electrical requirements for some specific system design.
5. Derating may be needed under low input voltages. Please check the static curve for more details.
6. The power supply is considered as a component that will be operated in combination with final equipment. Since EMC performance will be affected by the complete installation, the final equipment manufacturers must re-qualify EMC Directive on the complete installation again





E. Electronic Curve

- Derating Curve

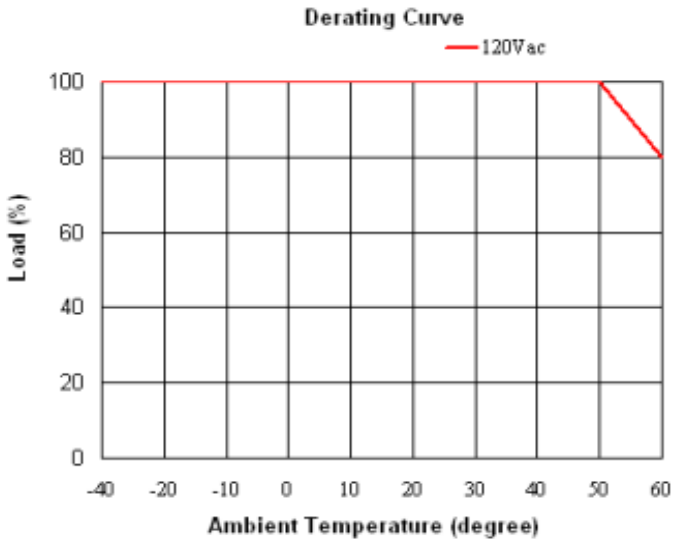

- Static Curve

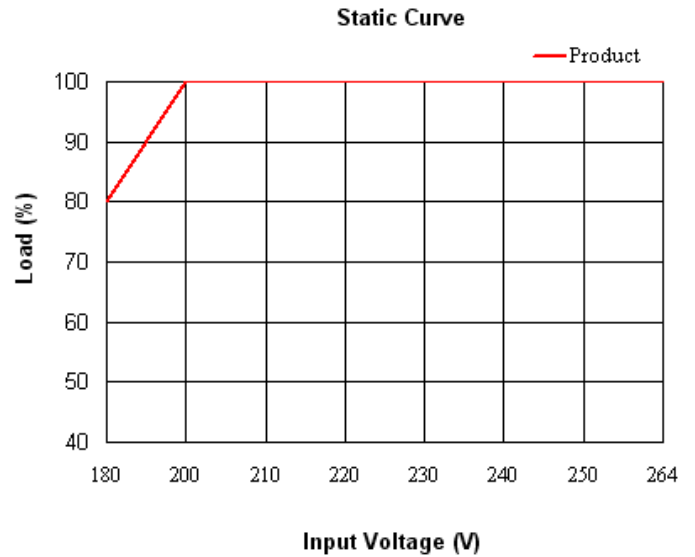

- Power Factor Characteristics Curve

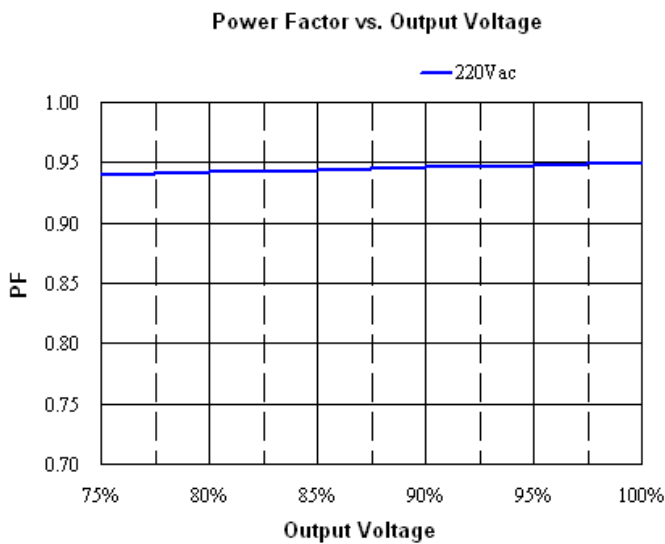

- Efficiency Characteristics Curve

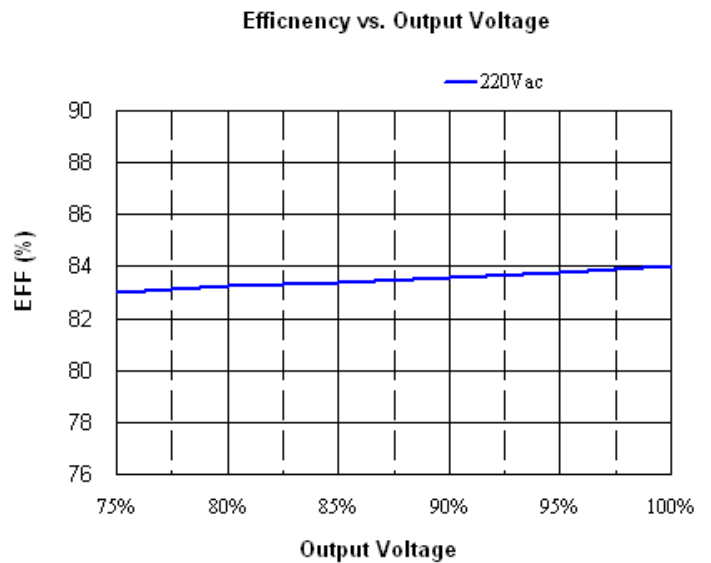

- Life Time vs. Case Temperature Curve

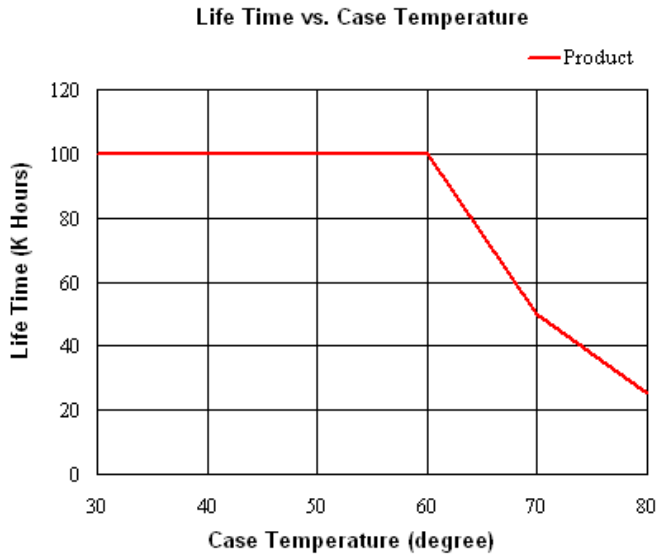

F. Mechanical Outline

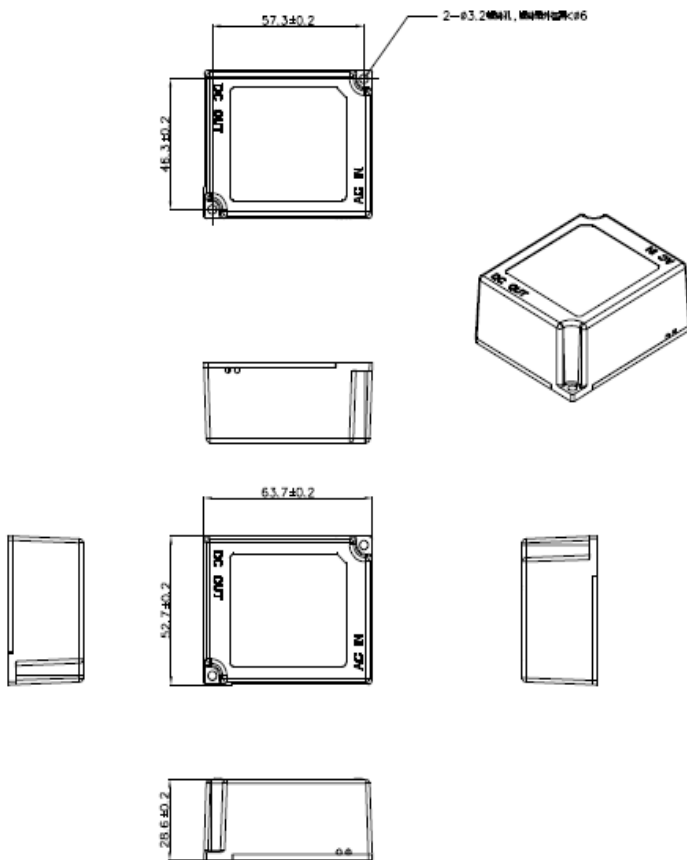



High Quality
Evolution
Commitment

HEC-20LTT-XXPSAS(230Vac) Rev A

G. RoHS Compliance Outline

Our products comply with the European Directive 2011/65/EU, calling for the elimination of lead and other hazardous substances from electronic products.

H. Revision History

Change Date	Rev.	Description of Change		
		Item	From	To
2013-11-01	A	Datasheets Release	/	/

