

参数规格(PRODUCT SPECIFICATION)

A. 一般规格(General Specification)

项目(ITEMS)	性能(DESCRIPTION)		
规格型号/Model No	SA12038H2S-H		
尺寸/Dimension	120×120×38mm		
马达形式/Motor Type	<input checked="" type="checkbox"/> 罩极式马达 (Shaded Pole Induction Motor)	<input type="checkbox"/> 电容式马达 Capacitor-Run Ind.Motor	
转子形式/Rotor Type	<input checked="" type="checkbox"/> 内转子 (Internal rotor motor)	<input type="checkbox"/> 外转子 (External rotor motor)	
扇 框/Fan Case	铝合金(Aluminum Alloy)	黑色喷涂 (Black painting)	
扇 叶/Fan Blade	Thermoplastic PBT	5Blades	
转动方向/Direction of Rotation	顺时针(clockwise) 标签面 Label Side		
电 压/Voltage	200~240(VAC)		
启动电压/Starting Voltage	165(VAC)		
频 率/Frequency	50(Hz)	60(Hz)	a. 额定电压 / Rated Voltage b. 25℃ c. 65% RH d. Measured after 5 mins e. 风洞测试仪/PQ Measurement Apparatus : (LW9266-SR) f. 标准/Standard : AMCA
转 速/Speed	2600(rpm)	3000(rpm)	
运转电流/Current	0.14(A)	0.11(A)	
输入功率/Input Power	23.0(W)	20.0(W)	
锁定电流/Locked Rotor Current	0.16(A)MAX	0.13(A)MAX	
最大风量/Max. Air Flow	83(CFM)	92(CFM)	
最大静压/Max. Static Pressure	0.27(Inch-H ₂ O)	0.33(Inch-H ₂ O)	
运转噪音/Noise Level	40(dB)	43(dB)	
绝缘阻抗/Insulation resistance	500V 直流电 (500Megohms minimum at DC500V)		
绝缘耐压/Dielectric Withstand Voltage	1800V 交流电 3 秒 (AC1800 V for 3 second)		
绝缘等级/Insulation Class	E 级(Class E)		
轴 承/Bearing	<input type="checkbox"/> 双滚珠轴承 (Dual Ball Bearing) <input checked="" type="checkbox"/> 含油轴承 (Sleeve Bearing)		
使用寿命/Life Expectation	常温常湿 30000 小时 (30000h at 40℃, RH60%)		
导 线/Lead Wire	插片 Terminal		
重 量/Weight	550(g)		
特殊功能/Special Function	No		
安规认证/Safety Certificate	CE UL		

B. 商标 (Label Marking)

	型号/Model No	SA12038H2S-H
	额定电压/Rated Voltage	220VAC
	额定功率/Rated Power	20/23W
	标签尺寸/Label Size	Φ61mm
	商标颜色/Label Color	Blue
	安规/Safety	CE UL
	附加码/Appendix Code	No

C. 外框尺寸 (Outline Dimension)

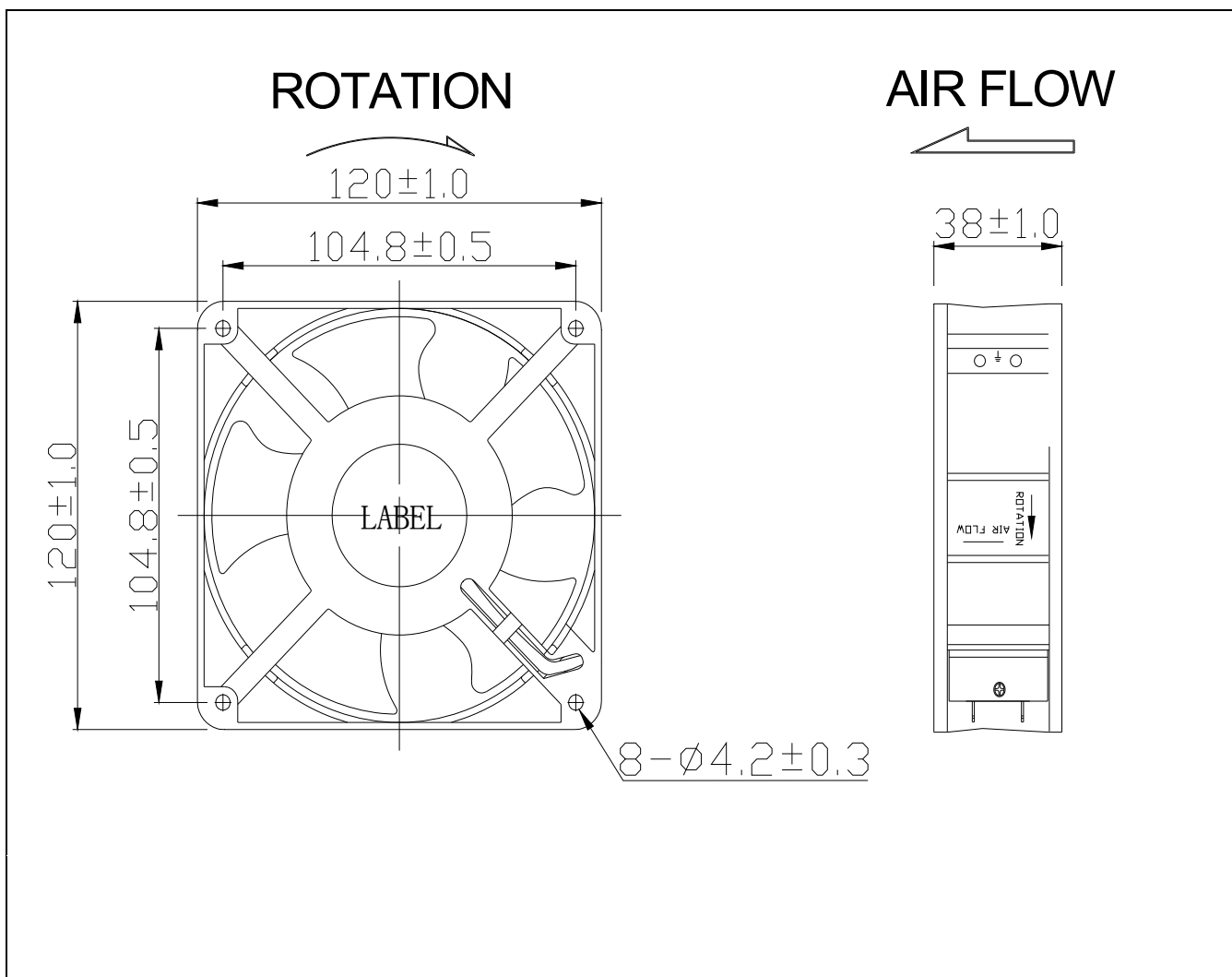

Note:

1. We will not guarantee the products if your application exceeds the limitations outlined in this specification.
2. Please do not touch and push fan blade with fingers or others. Fan blade and ball bearings may be damaged. And it caused noise defect.
3. Please avoid operating YIMENG's products in poisonous material (organic, cyanogens, formalin, phenol, etc.) or corrosive gas environment (H_2S , SO_2 , NO_2 , etc.)
4. We do not warrant performance safety against accidents caused by dust, water, droplets dew, bugs, etc.
5. Always ensure that fans are stored according to the storage temperatures specified. Do not store in a high humidity environment. If the fans are stored for more than 6 months, we recommend functional testing before using.
6. Please do not damage this product this product including coil and lead wires while installing or wiring. There may be smoking or fire.
7. Avoid the damage, check the correct voltage and proper polarity before connecting with power.
8. Improper mounting may cause harsh resonance, vibration, and noise. Please mount securely.
9. It is very important to notify that avoid to drop from 60cm height when in any movement or operation, it will impact the balance of blade. Especially ball bearing structure is avoided to drop down.
10. Safety is a top priority. Please furnish guard accessories to prevent injury to personnel