

CUSTOMER : _____.

DATE : _____.

Rev. : REV. 2 .

SPECIFICATIONS FOR APPROVAL

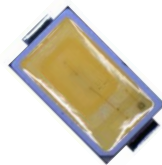

Top View Type White SMD LED

MODEL NAME : LEMWS57Q80HZ00

RoHS
Compliant

APPROVAL	REMARK	APPENDIX

DESIGNED	CHECKED	APPROVED

CONTENTS

1. Features	3
2. Outline Dimensions	3
3. Applications	4
4. Maximum Ratings	4
5. Electro-Optical Characteristics	4~5
6. Bin Structure	5~6
7. Typical Characteristic Curves	7~8
8. Reliability Test Items and Conditions	9
9. Packing and Labeling of Products	10~13
10. Cautions on Use	14~17
11. Disclaimers	17

1. Features

- Lighting Color : White
- Lead Frame Type LED Package : 5.7×3.0×0.9 mm (L×W×H)
- Viewing angle : extremely wide(120°)
- Chip Material : InGaN
- Soldering Methods : Reflow soldering

2. Outline Dimensions

(Unit : mm)

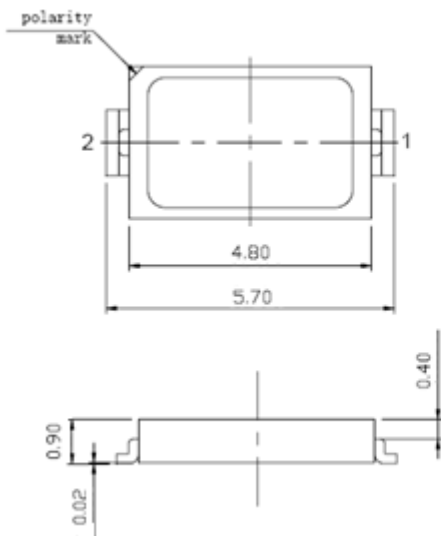

Internal circuit



Pad configuration

- ① Anode pad
- ② Cathode pad

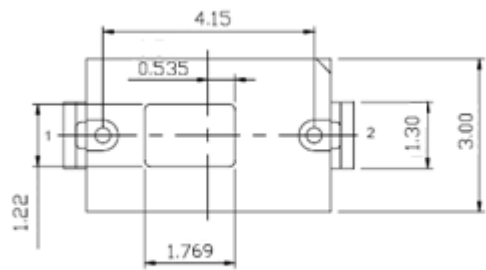

**Recommendable soldering pattern
(for reflow soldering)**

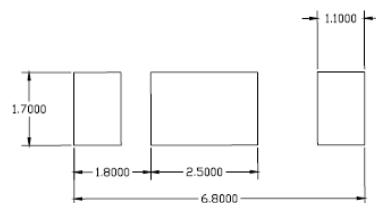

▪ Tolerances unless dimension ± 0.1 mm

3. Applications

- Interior and exterior illuminations

4. Maximum Ratings

(Ta=25°C)

Item	Symbol	Rating	Unit
Forward Current	If	100	mA
Peak Pulse Forward Current	Ifp	260	mA
Operating Temperature	Topr	-30 ~ +85	°C
Storage Temperature	Tstg	-40 ~ +100	°C
Junction Temperature	Tj	110	°C
Soldering Temperature	JEDEC-J-STD-020		
ESD Classification	Class 2 (JESD22-A114)		

- ※ The stresses beyond those listed under maximum ratings may cause permanent damages to the device .
These or any other conditions beyond those indicated under recommended operating conditions are not implied.
The exposure to the absolute maximum rated conditions may affect device reliability.
- ※ LEDs are not designed to be driven in reverse voltage.

5. Electro - Optical Characteristics

(Ta=25°C)

Item	Symbol	Condition	Min.	Typ.	Max.	Unit
Forward Voltage	Vf	If=65 [mA]	2.8	-	3.3	V
Luminous Flux	Φv	If=65 [mA]	22	25	-	lm
Luminous Intensity	Iv	If=65 [mA]	7	7.9	-	cd
Color	Cx / Cy	If=65 [mA]	Refer to '6. Rank Sorting Method'			-
Viewing Angle	2Θ1/2	If=65 [mA]	-	120	-	deg
Color Rendering Index (Ra)	-	If=65 [mA]	80	-	-	-
Thermal Resistance, Junction to Solder Point	Rth j-s	If=65 [mA]	-	21	-	°C/W
Typical Temperature Coefficient of Forward Voltage ^{*1)}	ΔVf / ΔTj	If=65 [mA]	-	-5	-	mV/°C

*1) Measured at Ta between 25°C and 85°C.

- ※ These values are measured by the LG Innotek optical spectrum analyzer within the following tolerances.
Luminous Flux (Φv) : ± 10%, Forward Voltage (Vf) : ± 0.1V, Color Value : ± 0.005, CRI Value : ± 2, Viewing Angle : ± 5°
- ※ Although all LEDs are tested by LG Innotek equipment, some values may vary slightly depending on the condition of the test equipment.

5. Electro - Optical Characteristics

If (mA)	Vf (V)	Power (W)	Φ_v (lm)	lm/W
20	2.74	0.055	8.3	151
40	2.85	0.114	15.9	139
60	2.95	0.177	23.3	132
65(typ.)	2.97	0.193	25.0	130
80	3.03	0.242	30.2	125
100	3.11	0.311	36.9	119

※ Φ_v values are for representative references only.

6. Bin Structure

▪ Forward Voltage Bins(@65mA)

Bin	Vf	
	Min.	Max.
9	2.8	2.9
0	2.9	3.0
1	3.0	3.1
2	3.1	3.2
3	3.2	3.3

▪ Luminous Flux Bin(@65mA)

Bin	Φ_v	
	Min.	Max.
Q	22	-

▪ CRI Bin(@65mA)

Bin	CRI	
	Min.	Max.
80	80	-

▪ Color Bins (@65mA)

Bin	Cx	Cy
H1	0.3376	0.3616
	0.3464	0.3688
	0.3452	0.3558
	0.3371	0.3493
H2	0.3371	0.3493
	0.3452	0.3558
	0.3441	0.3428
	0.3366	0.3369
H3	0.3464	0.3688
	0.3551	0.3760
	0.3533	0.3624
	0.3452	0.3558
H4	0.3452	0.3558
	0.3533	0.3624
	0.3515	0.3487
	0.3452	0.3558

※ Bin structure: Please refer to the following example.

Bin Code : Q-H1-0

(Φ_v Bin = Q, Color Bin = H1, Vf Bin = 0)

Color Bins Structure

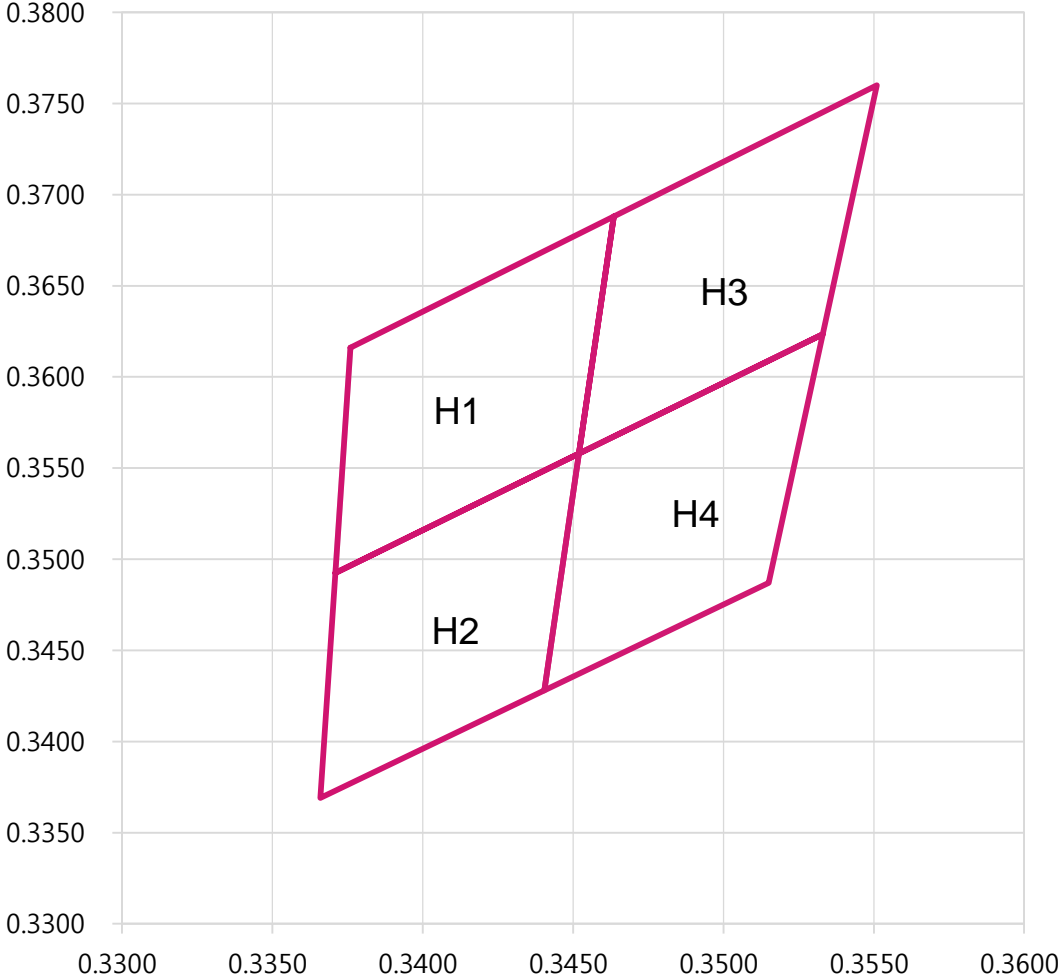

7. Typical Characteristic Curves

- Forward Current vs. Forward Voltage

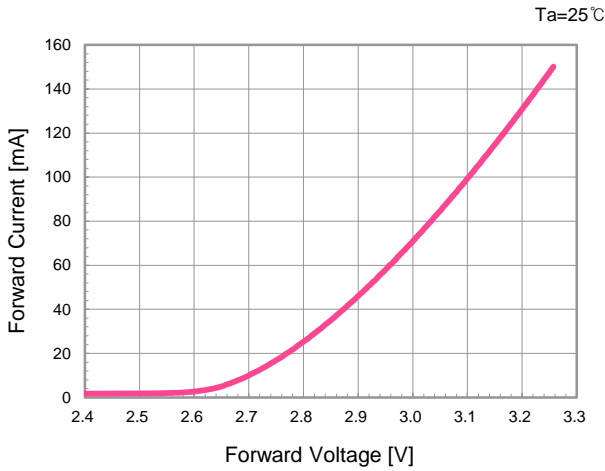

- Relative Luminous Flux vs. Forward Current

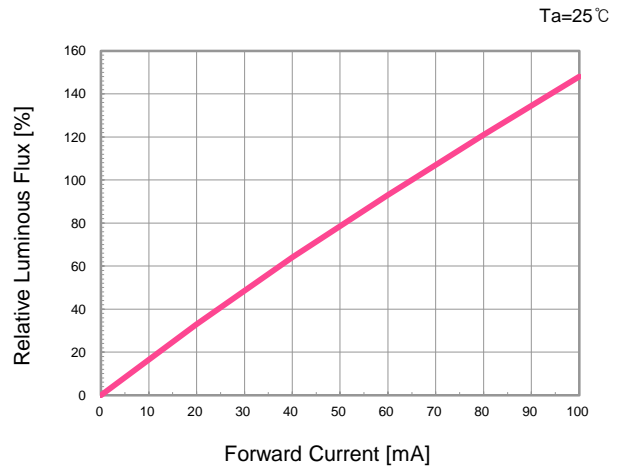

- Spectrum

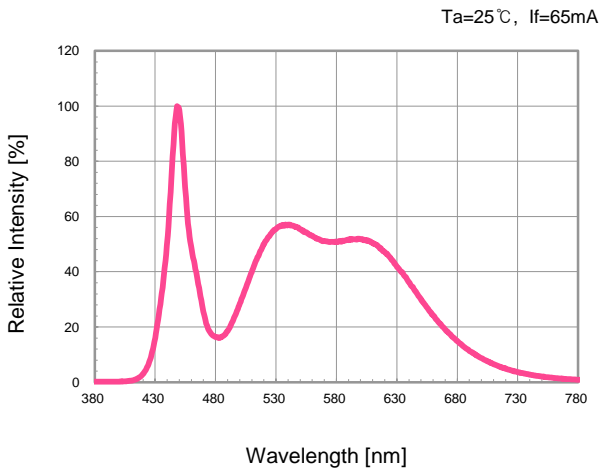

- Chromaticity Coordinate vs. Forward Current

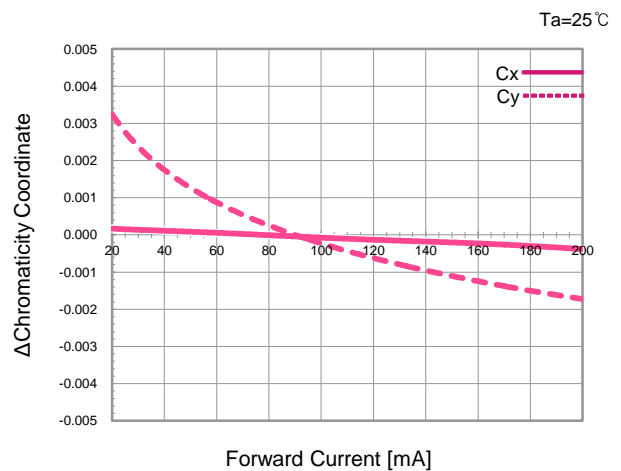

- Radiation Characteristics

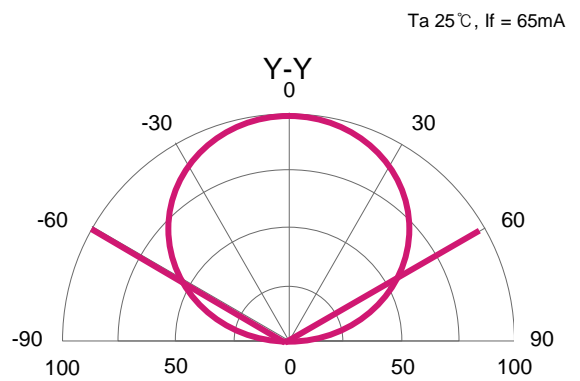
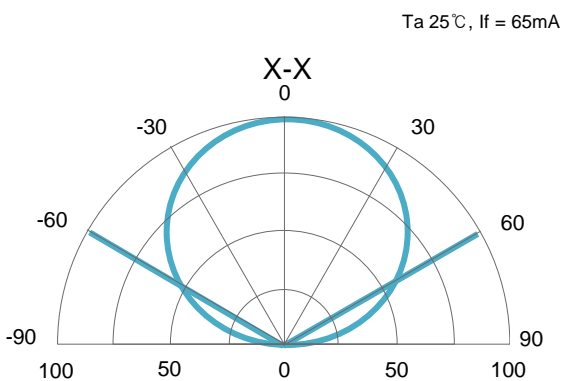

7. Typical Characteristic Curves

▪ Luminous Flux vs. Temperature

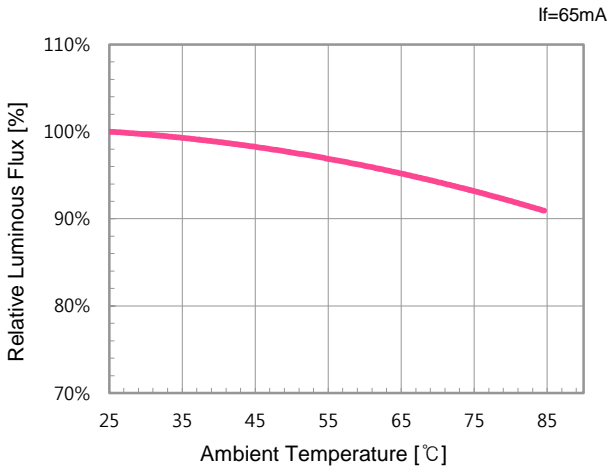

▪ Chromaticity Coordinate vs. Temperature

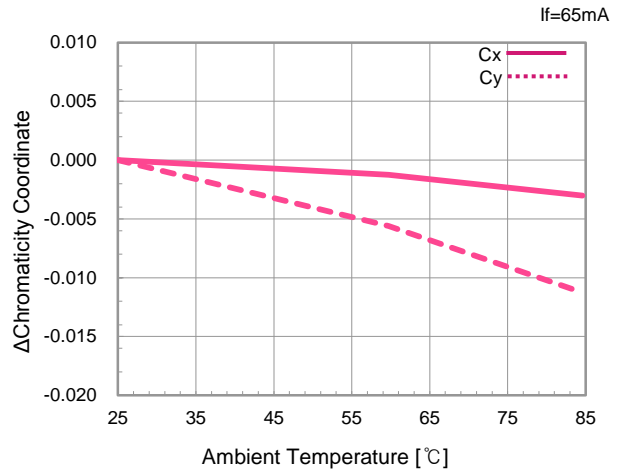

▪ Forward Voltage vs. Temperature

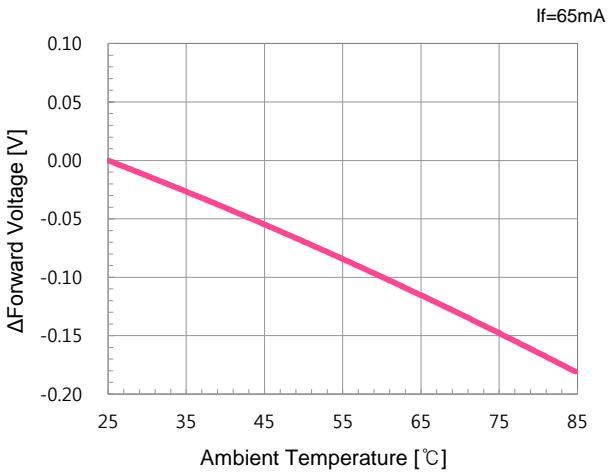

▪ Derating Curve

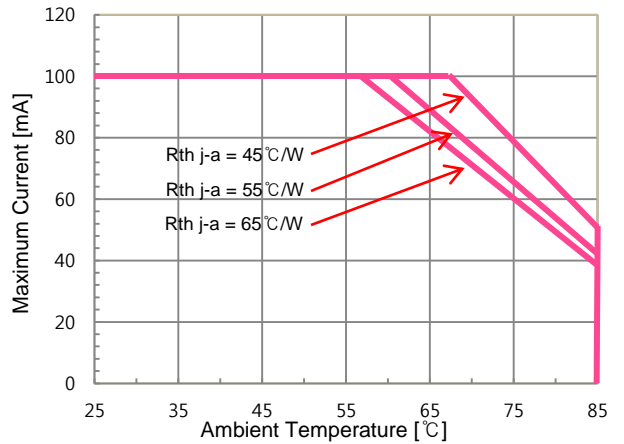

8. Reliability Test Items and Conditions

8-1. Criteria for Judging Damages

Items	Symbols	Test Conditions	Limits	
			Min.	Max.
Forward Voltage	V _f	I _f = 65mA	-	Initial value × 1.1
Luminous Flux	Φ _v	I _f = 65mA	Initial value × 0.7	-

8-2. Reliability Test

No	Items	Test Conditions	Test Hours /Cycles
1	Room Temperature Operating Life (RTOL)	T _a =25℃, I _f =80mA	1,000 hours
2	Temperature Humidity Operating Life (WHTOL)	T _a =60℃, RH=90%, I _f =65mA	1,000 hours
3	High Temperature Operating Life (HTOL)	T _a =85℃, I _f =65mA	1,000 hours
4	Low Temperature Operating Life (LTOL)	T _a =-30℃, I _f =65mA	1,000 hours
5	High Temperature Storage (HTSL)	T _a =100℃	1,000 hours
6	Low Temperature Storage (LTSL)	T _a =-40℃	1,000 hours
7	Temperature Humidity Storage (WHTSL)	T _a =85℃, RH=85%	1,000 hours
8	Temperature Cycling (TC)	-40℃(30 min.) ~ 25℃(5 min.) ~ 100℃(30 min.) ~ 25℃(5 min.)	100 cycles
9	Thermal Shock (TMSK)	100℃ ~ -40℃ Dwell : 15 min., Transfer : 10 sec.	100 cycles
10	Moisture Sensitivity Level (MSL)	T _{sld} =260℃, 10 sec. (Pre treatment 60℃,60%,168 hours)	3 times

※ The entire test fails if one (or more) LED(s) from the sample set remain(s) within the listed failure criteria.

9. Packing and Labeling of Products

9-1. Taping Outline Dimension

Dimension of Reel

(Unit : mm)

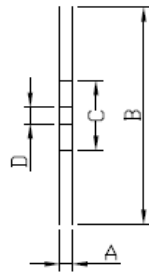
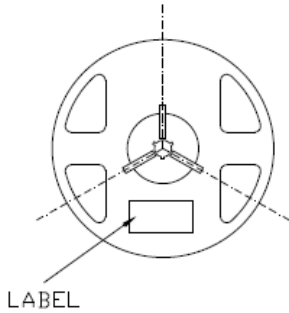

A	$12 \pm 0.1\text{mm}$
B	$179 \pm 1\text{mm}$
C	$58 \pm 1\text{mm}$
D	$13.5 \pm 0.5\text{mm}$

▪ Packing Materials :

- Reel : Conductive PS (Black)
- Emboss Tape : Conductive PS (Black)
- Cover Tape : Conductive PET Base

Dimension of Tape

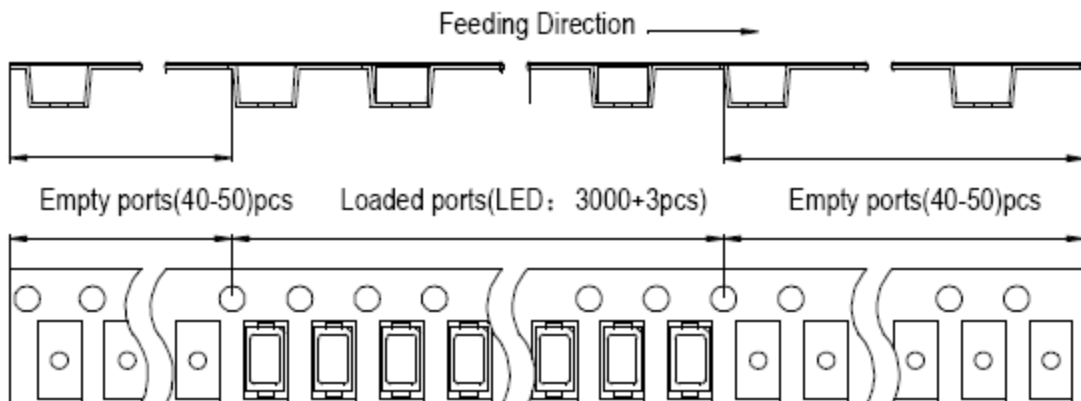
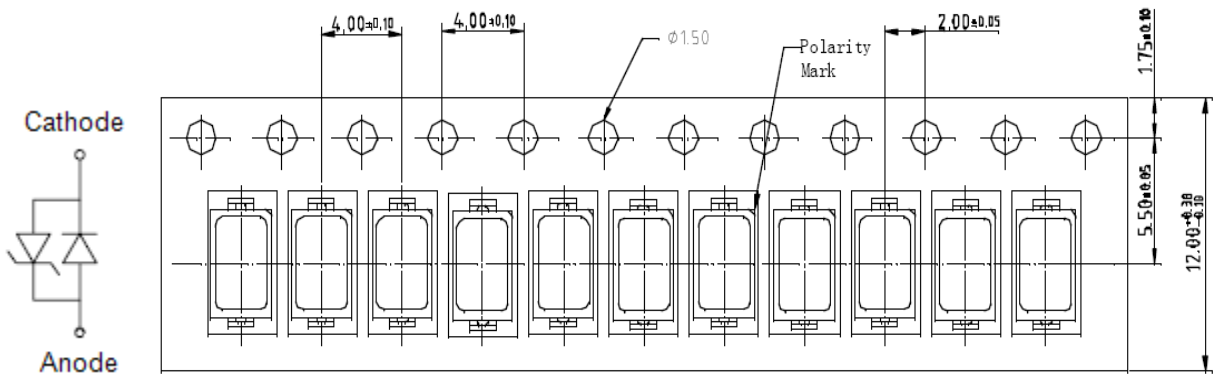

9-2. Label Structure

※. Label A

Specifying Model Name, Rank, Rank, Quantity and Run number

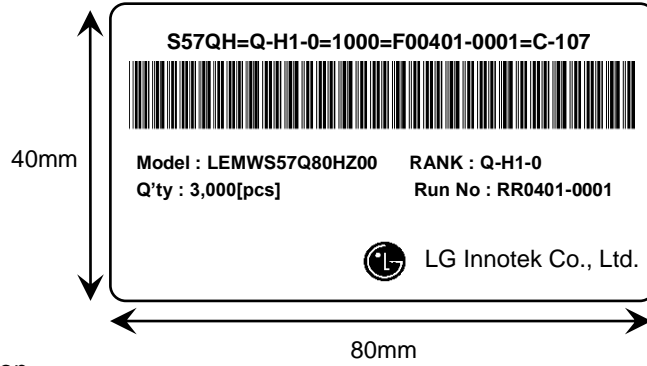

▪ Run No. indication

1	2	3	4	5	6	—	7	8	9	10
Code	Manufacture Site	Manufacture Year	Manufacture Month	Manufacture date			TH #		Serial No	
		2012 : 2 2013 : 3 ... 2020 : 0 2021 : 1	1~9 : 1~9 10 : A 11 : B 12 : C	(01~31)			(00 ~ 99)		(00 ~ ZZ)	

9-2. Label Structure

※ Label C

Specifying Date, Model Name, Quantity, Outbox ID, Rank/Rank Q'ty

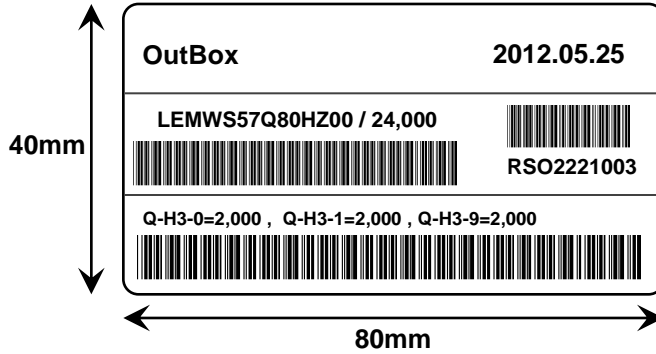

▪ Box ID. indication

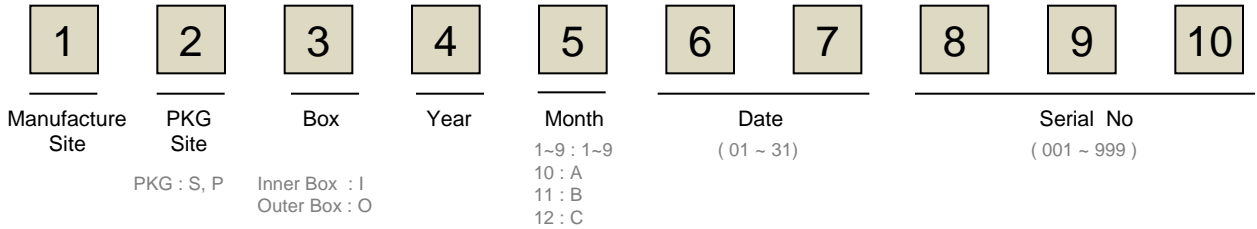

9-3. Packing Structure

Reeled products (3,000 pcs per bag) are packed in a sealed-off and moisture-proof aluminum bag with desiccants (silica gel). Four aluminum bags (12,000 pcs total per box) are packed in an inner box and six inner boxes are packed in an outer box (72,000 pcs per box).

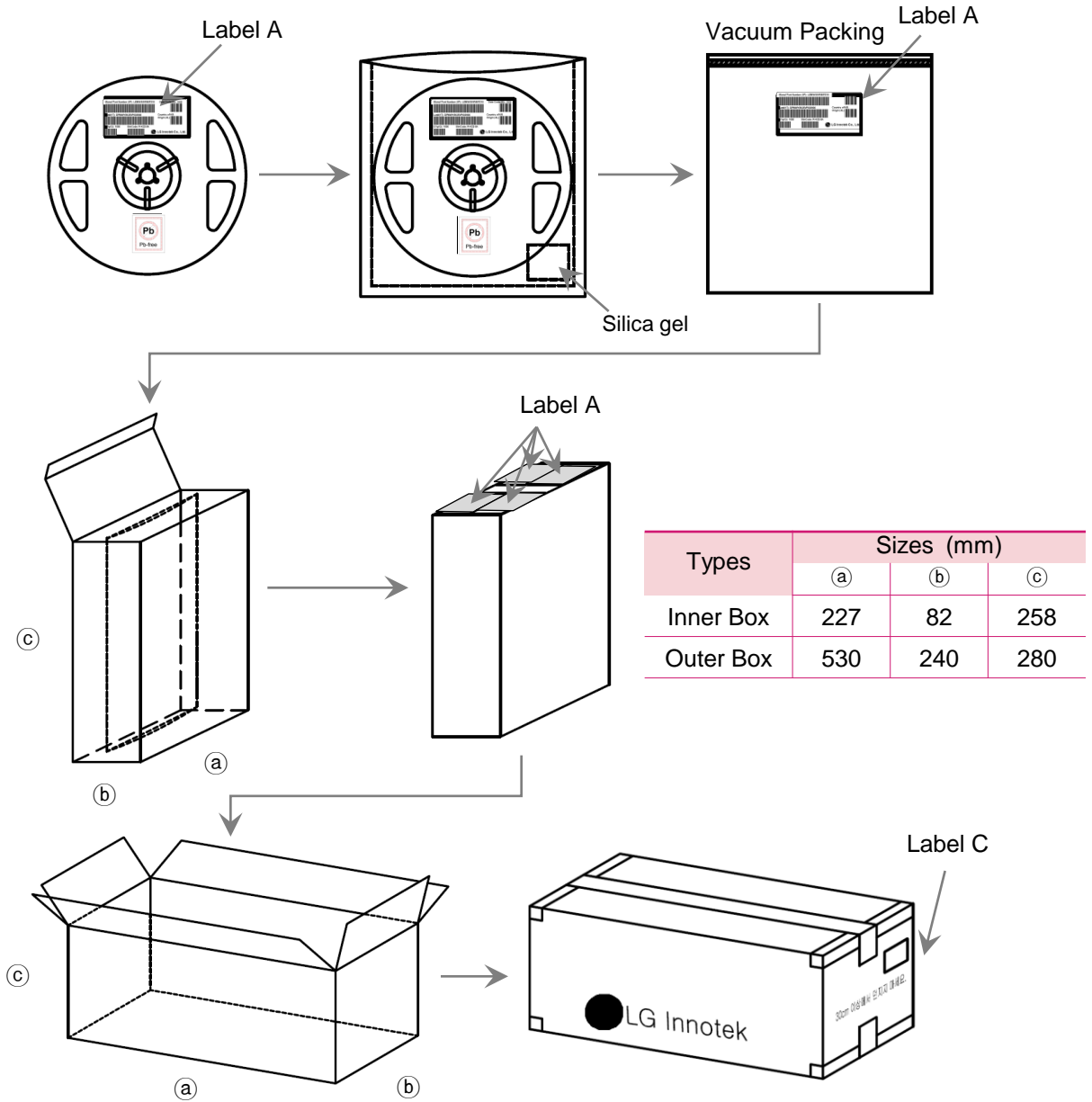

10. Cautions on Use

10-1. Moisture-Proof Package

- The moisture in the SMD package may vaporize and expand during soldering.
- The moisture can damage the optical characteristics of the LEDs due to the encapsulation.

10-2. During Storage

Conditions		Temperature	Humidity	Time
Storage	before Opening Aluminum Bag	< 30°C	< 50%RH	within 1 Year from Delivery Date
	after Opening Aluminum Bag	< 30°C	< 60%RH	≤ 672 hours
Baking		65 ± 5°C	< 10%RH	10 ~ 24 hours

10-3. During Usage

- LED should avoid the direct contact with exposure to hazardous materials such as sulfur, chlorine, phthalate, etc..
- The silver-plated metal parts on LEDs can be rusted when exposed to corrosive gases.
- The silver-plated metal parts also can be affected not only by the corrosive gases emitted inside of the end-products but by the gases penetrated from outside environment.
- The corrosive atmosphere must be avoided during the use and storage.
- Extreme environments such as sudden ambient temperature changes or high humidity that can cause condensation must be avoided.

10-4. Cleaning

- Do not use brushes for cleaning or organic solvents (i.e. Acetone, TCE, etc..) for washing as they may damage the resin of the LEDs.
- IPA is the recommendable solvent for cleaning the LEDs under the following conditions.
Clearing Condition : IPA, 25°C max. × 60sec max.
- Ultrasonic cleaning is not recommended.
- Pretests must be followed by the actual cleaning processes to avoid any possible damages to the LEDs.

10-5. Heat Generation

- The thermal design of the end product must be seriously considered even from the beginning stage.
- The co-efficiency between the heat generation and the input power is affected by the thermal resistance of the circuit boards and the density of the LED placements together with other components.

10-6. Static Electricity

- Wristbands and anti-electrostatic gloves are strongly recommended and all devices, equipments and machineries must be properly grounded when handling the LEDs which are sensitive against static electricity and surge.
- Precautions are to be taken against surge voltage to the equipment that mounts the LEDs.
- Some unusual characteristics such as significant increase of current leakage, decrease of turn-on voltage, or no operation at a low current can be occurred by damaged LEDs.

10-7. Recommended Circuit

- The current through each LED must not exceed the absolute maximum rating when design the circuits.
- In general, there can be various forward voltages for LEDs. Different forward voltages in parallel via a single resistor can result different forward currents to each LED, which also can output different luminous flux values. In the worst case, the currents can exceed the absolute maximum ratings which can stress the LEDs. Matrix circuit with a single resistor for each LED is recommended to avoid the luminous flux fluctuations.

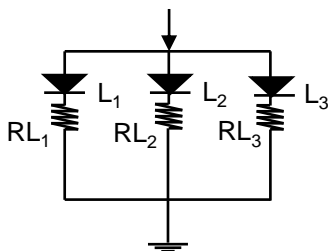

Fig.1 Recommended Circuit in Parallel Mode
: Separate resistors must be used for each LED.

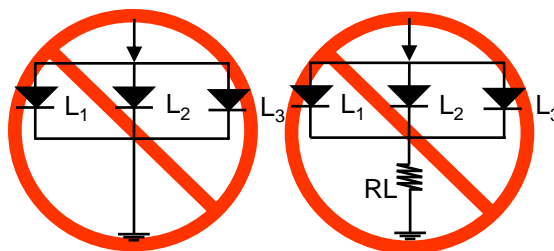
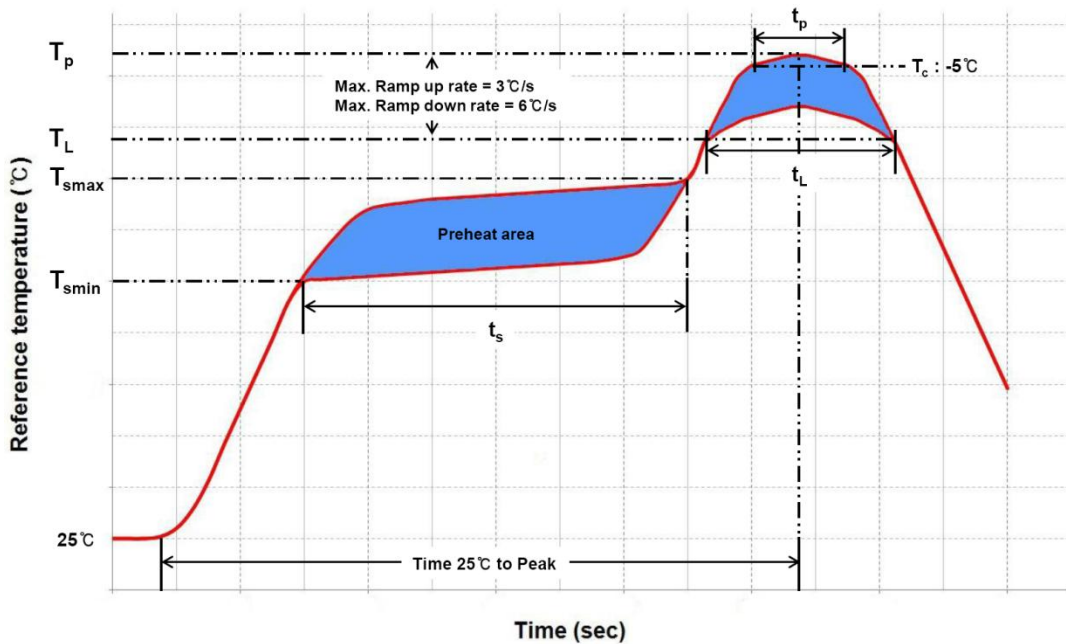

Fig.2. Abnormal Circuit
Circuits to Avoid: The current through the LEDs may vary due to the variation in LED forward voltage.

- The driving circuits must be designed and operated by forward bias only so that the LEDs are not to be operated by the reverse voltages while turned off, which can damage the LEDs.
- Reverse voltage can damage the zener diode and cause destructions.
- Constant-current operation by driver IC controller is recommended.

10-8. Soldering Conditions

- Reflow soldering method is recommended for LEDs assembly.
- LG Innotek does not guarantee the performance of the LEDs assembled by dip soldering method.
- Recommended Soldering Profile (according to JEDEC J-STD-020D)



Profile Feature	Pb-Free Assembly	Pb-Based Assembly
Preheat/Soak		
Temperature Min(T_{smin})	150°C	100°C
Temperature Max(T_{smax})	200°C	150°C
Maximum time(t_s) from T_{smin} to T_{smax}	60~120 seconds	60~120 seconds
Ramp-up rate (T_L to T_p)	3°C/ second max.	3°C/ second max.
Liquidous temperature (T_L)	217°C	183°C
Maximum peak package body temperature (T_p)	260°C	235°C
Time (t_L) maintained above T_L	60~150 seconds	60~150 seconds
Time(t_p) within 5°C of the specified temperature (T_c)	30 seconds	20 seconds
Ramp-down rate (T_p to T_L)	6°C/second max.	6°C/second max.
Maximum Time 25°C to peak temperature	8minutes max.	6minutes max.

- Reflow or hand soldering at the lowest possible temperature is desirable for the LEDs although the recommended soldering conditions are specified in the above diagrams.
- A rapid cooling process is not recommended for the LEDs from the peak temperature.
- The LEDs encapsulate silicone and have soft surfaces on the tops, which can easily be damaged by pressure. Precautions should be taken to avoid strong pressure on the encapsulated part when leveraging the pick and place machines. The pick up nozzles should not directly contact the silicone resin of the LEDs.
- Reflow soldering should not be done more than two times.

10-9. Soldering Iron

- The recommended condition is less than 5 seconds at 260 °C.
- The time must be shorter for the higher temperature. (+10°C → -1sec).
- The power dissipation of the soldering iron should be lower than 15W when the surface temperature of the device should be controlled at or under 230 °C.

10-10. Eye Safety Guidelines

- Do not directly look at the light when the LEDs are on.
- Proceed with caution to avoid the risk of damage to the eyes when examining the LEDs with optical instruments.

10-11. Manual Handling

- Use Teflon-type tweezers to grab base of LED and do not touch the lens.

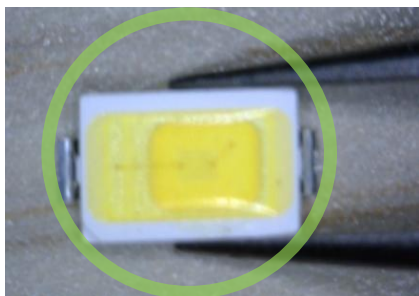

11. Disclaimers

- LG Innotek is not responsible for any damages caused by any accidents or operational environments exceeding the absolute maximum ratings.
- Generally accepted electronic equipments must be used to operate the LEDs in this document.
- Consultation with LG Innotek is recommended for unassured environments or operations to avoid any possible malfunctions or damages of the products or risk of life or health.
- Any unauthorized, without prior written consents from LG Innotek, disassembly is prohibited if purposed for reverse-engineering. All defected LEDs must be reported to LG Innotek and not to be disassembled or analyzed.
- The products can be modified and upgraded without prior notice.