

# MORNSUN®

## URA\_(X)D-10WR2& URB\_(X)D-10WR2 Series 10W,ULTRA-WIDE INPUT ISOLATED& REGULATED DUAL/SINGLE OUTPUT DIP PACKAGING, DC-DC CONVERTER



Patent Protected RoHS

### PART NUMBER SYSTEM

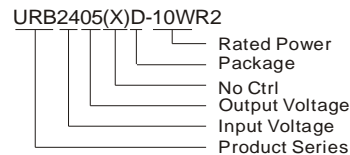

### FEATURES

- 4:1 wide input voltage range
- Efficiency up to 88%
- 1.5KVDC isolation
- Short circuit protection
- Output over voltage protection
- Operating Temperature range: -40°C ~ +85°C
- Six-sided metal shield
- Industry standard pinout
- Low ripple & noise
- Meet CISPR22/EN55022 CLASS A
- Inverse polarity protection for A2S (chassis mounting) and A4S (DIN-Rail mounting)

### APPLICATION

URA\_(X)D-10WR2&URB\_(X)D-10WR2 series models provide 10 Watt output power, with 4:1 wide range of 9-36VDC,18-75VDC,output over-voltage and short-circuit protection. And all of them can meet CISPR22/EN55022 CLASS A without external circuit. Typical applications for these converters are industrial, electric power, instrumentation, telecommunication.

### SELECTION GUIDE

Model ①	Input Voltage(VDC)		Output Voltage (VDC)	Output Current (mA)		Input Current (mA)(Typ.)		Reflected Ripple Current (mA,Typ.)	Max. Capacitive Load ③ (μF)	Efficiency (%.Typ.) ④ @Max. Load
	Nominal (Range)	Max. ②		Max.	Min.	@Max. Load	@No Load			
URA2405(X)D-10WR2	24 (9-36)	40	±5	±1000	±50	502	12	40	680	83
URA2412(X)D-10WR2			±12	±416	±21	484			220	86
URA2415(X)D-10WR2			±15	±333	±16	473			100	88
URB2403(X)D-10WR2			3.3	2400	120	418			2200	79
URB2405(X)D-10WR2			5	2000	100	508			2200	82
URB2412(X)D-10WR2			12	833	42	484			470	86
URB2415(X)D-10WR2			15	667	33	479			330	87
URB2424(X)D-10WR2			24	416	21	479			100	87
URA4805(X)D-10WR2	48 (18-75)	80	±5	±1000	±50	251	6	30	680	83
URA4812(X)D-10WR2			±12	±416	±21	242			150	86
URA4815(X)D-10WR2			±15	±333	±16	237			100	88
URB4803(X)D-10WR2			3.3	2400	120	209			2200	79
URB4805(X)D-10WR2			5	2000	100	254			2200	82
URB4812(X)D-10WR2			12	833	42	242			330	86
URB4815(X)D-10WR2			15	667	33	239			220	87
URB4824(X)D-10WR2			24	416	21	239			100	87

Note:

① "X" means the model without Ctrl pin, series with suffix "A2S" are chassis mounting, with suffix "A4S" are DIN-Rail mounting, for example URB2405XD-10WR2A2S is chassis mounting without Ctrl pin,URB2405D-10WR2A4S is DIN-Rail mounting with Ctrl pin;

② Absolute maximum rating without damage on the converter;

③ For dual-output-converters the given value is for one output (for both outputs the same value);

④ The efficiency of "A2S" and "A4S" is approx. 2% lower.

INPUT SPECIFICATIONS					
Item	Test Conditions	Min.	Typ.	Max.	Unit
Input Surge Voltage (1sec. max.)	24VDC input	-0.7	--	50	VDC
	48VDC input	-0.7	--	100	
Start-up Voltage	24VDC input	--	--	9	
	48VDC input	--	--	18	
Input Filter		Pi Filter			
Ctrl *	Models ON	Ctrl open or connect high level (3.5-12VDC)			
	Models OFF	Ctrl connect GND or low level (0-1.2VDC)			
	Input current (Models OFF)	--	1	3	mA

Note: \*The Ctrl pin voltage is referenced to GND.

OUTPUT SPECIFICATIONS					
Item	Test Conditions	Min.	Typ.	Max.	Unit
Output Voltage Accuracy		--	±1	±2	%
Output Voltage Balance	Dual output, balanced Loads	--	±0.5	±1.5	
Line Regulation	Full load, Input voltage from low to high	--	±0.2	±0.5	
Load Regulation	5% to 100% load	--	±0.5	±1	
Cross Regulation	Dual output, main output 50% load, secondary output from 10% to 100% load	--	--	±5	
Transient Recovery Time	25% load step change	--	300	500	µs
Transient Response Deviation		--	±3	±5	%
Temperature coefficient	100% load	--	--	±0.03	%/°C
Ripple*	20MHz bandwidth	--	15	35	mVp-p
Noise*		--	40	80	
Output Over Voltage Protection	Input voltage range	110	120	140	%Vo
Output Short Circuit Protection		Continuous, automatic recovery			

Note: \* Ripple and noise tested with "parallel cable" method. See detailed operation instructions at *DC-DC application notes*.

COMMON SPECIFICATIONS						
Item	Test Conditions	Min.	Typ.	Max.	Unit	
Isolation Voltage	Input-Output, tested for 1 minute, leakage current less than 1 mA	1500	--	--	VDC	
Isolation Resistance	Input-Output, test at 500VDC	1000	--	--	MΩ	
Isolation Capacitance	Input-Output, 100KHz/0.1V	--	1000	--	pF	
Switching Frequency	PWM mode	--	350	--	KHz	
MTBF	MIL-HDBK-217F@25°C	1000	--	--	K hours	
Case Material		Aluminum Alloy				
Size	PCB mounting	50.8x25.4x11.8				mm
	A2S chassis mounting	76.0x31.5x21.2				
	A4S DIN-Rail mounting	76.0x31.5x25.8				
Weight	PCB mounting	--	22	--	g	
	A2S chassis mounting	--	44	--		
	A4S DIN-Rail mounting	--	64	--		

ENVIRONMENTAL SPECIFICATIONS					
Item	Test Conditions	Min.	Typ.	Max.	Unit
Storage Humidity	Non condensing	5	--	95	%
Operating Temperature	Power derating (above 71°C, see Figure 5)	-40	--	85	°C
Storage Temperature		-55	--	125	
Max. Case Temperature	Operating Temperature curve range	--	--	105	
Lead Temperature	1.5mm from case for 10 seconds	--	--	300	
Cooling		Free air convection			
Vibration		10-55Hz, 10G, 30 Min. along X, Y and Z			

## EMC SPECIFICATIONS

EMI	CE	CISPR22/EN55022	CLASS A (Without External Circuit) / CLASS B (External Circuit Refer to Figure1-② or Figure 3)	
	RE	CISPR22/EN55022	CLASS A (Without External Circuit) / CLASS B (External Circuit Refer to Figure1-② or Figure 3)	
EMS	ESD	IEC/EN61000-4-2	Contact $\pm 4KV$ perf. Criteria B	
	RS	IEC/EN61000-4-3	10V/m perf. Criteria A	
	EFT	IEC/EN61000-4-4	$\pm 2KV$	perf. Criteria B (External Circuit Refer to Figure1-①)
		IEC/EN61000-4-4	$\pm 4KV$	perf. Criteria B (External Circuit Refer to Figure 3)
Surge	IEC/EN61000-4-5	$\pm 2KV$	perf. Criteria B (External Circuit Refer to Figure1-① or Figure 3)	
EMS	CS	IEC/EN61000-4-6	3 Vr.m.s perf. Criteria A	
	Voltage dips, short and interruptions immunity	IEC/EN61000-4-29	0%-70% perf. Criteria B	

## EMC RECOMMENDED CIRCUIT

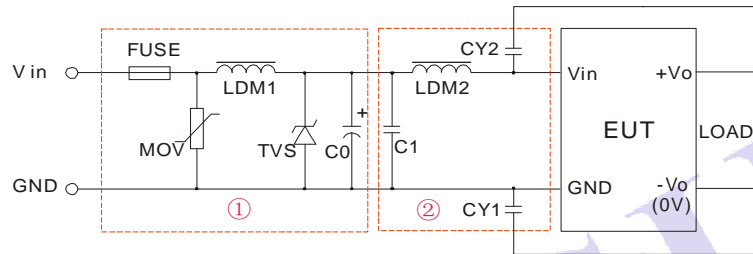

(Figure1)

Recommended external circuit parameters:

Model	Vin:24V	Vin:48V
FUSE	Choose according to actual input current	
MOV	S14K35	S14K60
LDM1	56 $\mu$ H	
TVS	SMCJ48A	SMCJ90A
C0	330 $\mu$ F/50V	330 $\mu$ F/100V
C1	1 $\mu$ F/50V	1 $\mu$ F/100V
LDM2	4.7 $\mu$ H	
CY1	1nF /2KV	
CY2	1nF /2KV	

Note: In Figure 1, part① is EMS recommended external circuit, part② is EMI recommended external circuit. Choose according to requirements.

## EMC RECOMMENDED CIRCUIT PCB LAYOUT

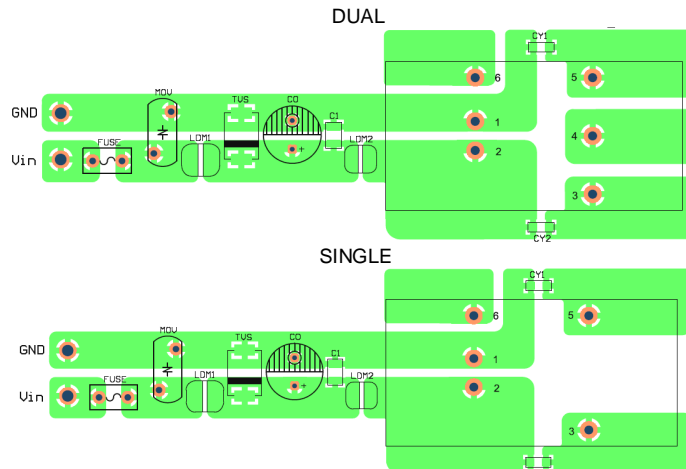

Note: The pad space between input and output (CY1/CY2) must  $\geq 2mm$ .  
(Figure 2)

## EMC MODULE APPLICATION CIRCUIT

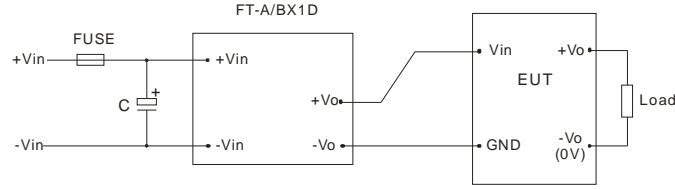

FT-A/BX1D is MORNSUN's EFT suppresser. For specific model, please refer to the selection guide.

For nominal input voltage of 12V or 24V,  $C \geq 330\mu\text{F}/50\text{V}$

For nominal input voltage of 48V,  $C \geq 330\mu\text{F}/100\text{V}$

(Figure 3)

## EMC MODULE RECOMMENDED CIRCUIT PCB LAYOUT

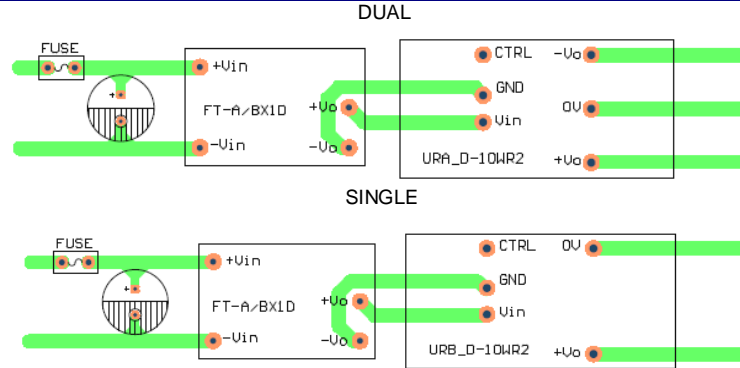

(Figure 4)

## EMI TEST WAVEFORM (RECOMMENDED CIRCUIT FIGURE 1-②)

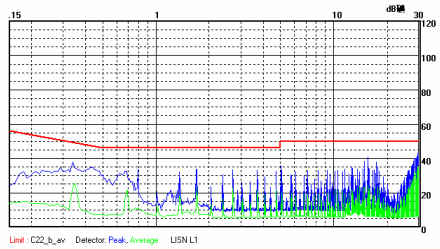

URB2405D-10WR2 CE (Class B, Positive line)

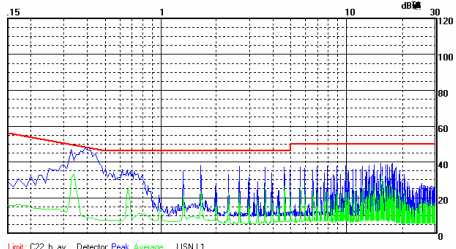

URB4805D-10WR2 CE (Class B, Positive line)

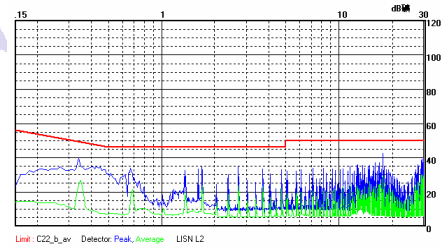

URB4805D-10WR2 CE (Class B, Negative line)

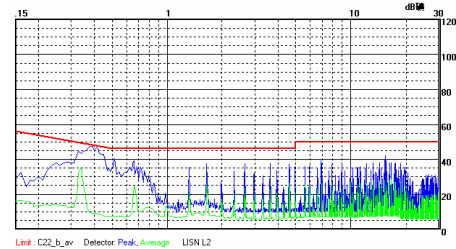

URB4805D-10WR2 CE (Class B, Negative line)

## PRODUCT TYPICAL PERFORMANCE CURVE

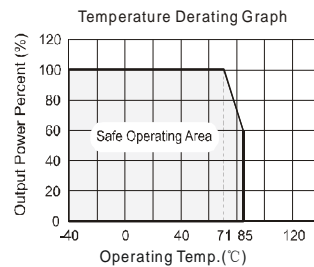

(Figure 5)

**Efficiency VS Input Voltage curve  
(Full Load)**

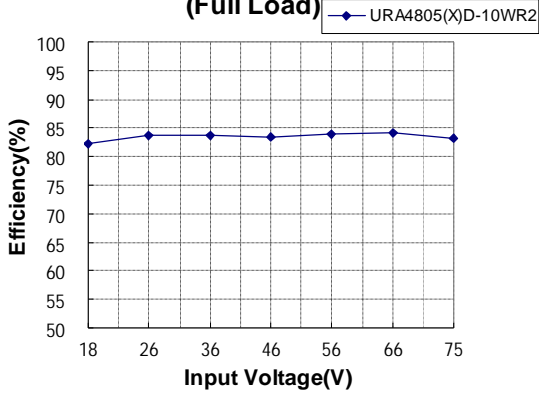

**Efficiency VS Output Load curve  
(Vin=Vin-nominal)**

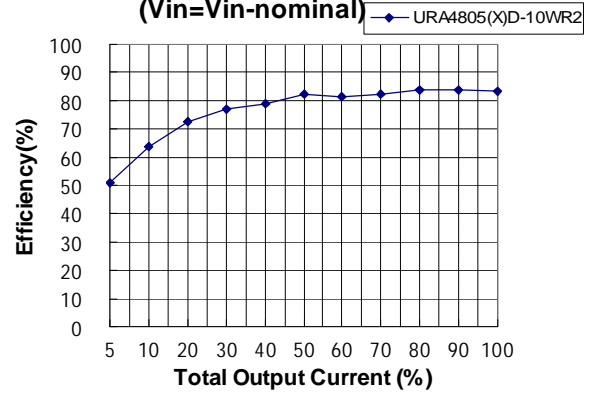

**Efficiency VS Input Voltage curve  
(Full Load)**

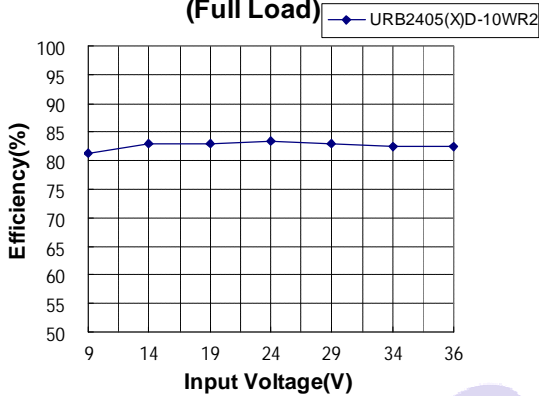

**Efficiency VS Output Load curve  
(Vin=Vin-nominal)**

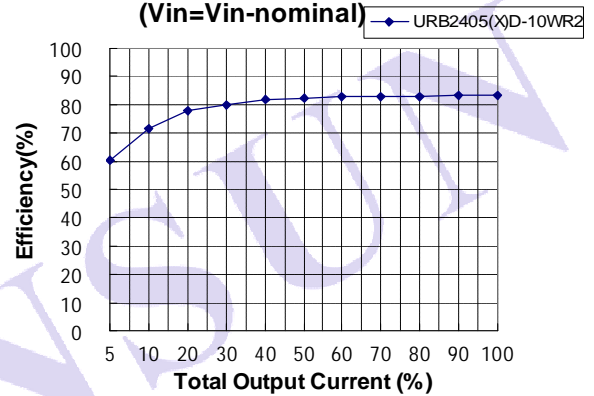

**URA\_(X)D-10WR2& URB\_(X)D-10WR2 PCB MOUNTING OUTLINE DIMENSIONS,RECOMMENDED FOOTPRINT**

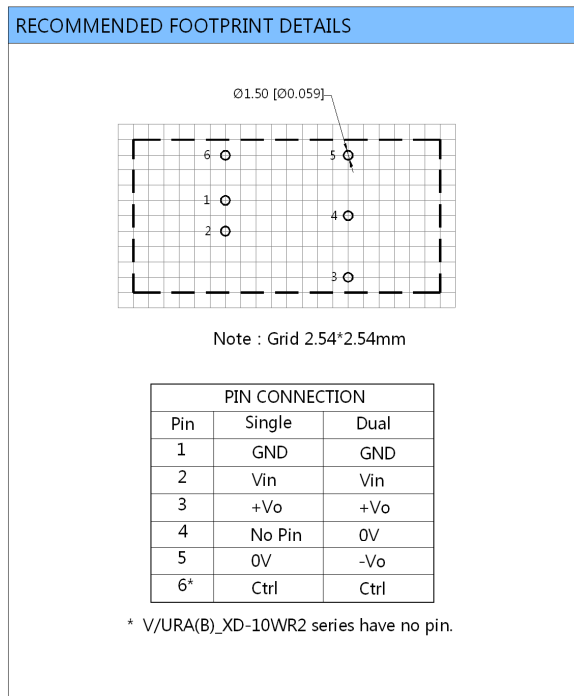
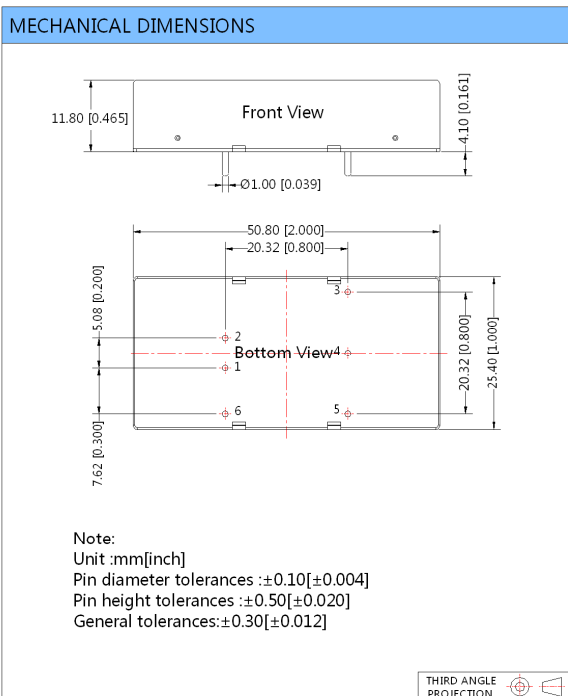

## URA\_(X)D-10WR2A2S& URB\_(X)D-10WR2A2S CHASSIS MOUNTING OUTLINE DIMENSIONS



Footprint Details						
Pin	1*	2	3	4	5	6
URA_(X)D	Ctrl	GND	Vin	-Vo	0V	+Vo
URB_(X)D	Ctrl	GND	Vin	0V	NC	+Vo

\*URA/B\_XD-10WR2A2S series have no connection

### MECHANICAL DIMENSIONS

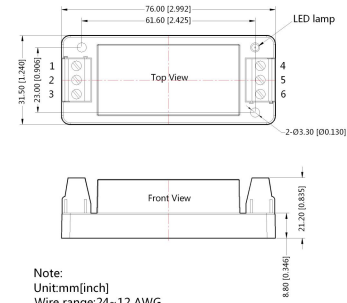

Note:  
 Unit:mm[inch]  
 Wire range:24-12 AWG  
 General tolerances:±0.50[±0.020]

THIRD ANGLE PROJECTION

## URA\_(X)D-10WR2A4S& URB\_(X)D-10WR2A4S DIN-RAIL MOUNTING OUTLINE DIMENSIONS



DIN-rail modules are fitting to TS35 rails

Footprint Details						
Pin	1*	2	3	4	5	6
URA_(X)D	Ctrl	GND	Vin	-Vo	0V	+Vo
URB_(X)D	Ctrl	GND	Vin	0V	NC	+Vo

\*URA/B\_XD-10WR2A4S series have no connection

### MECHANICAL DIMENSIONS

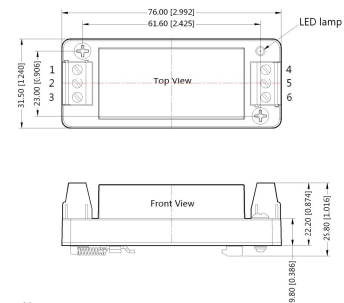

Note:  
 Unit:mm[inch]  
 Wire range : 24-12 AWG  
 General tolerances:±0.50[±0.020]

THIRD ANGLE PROJECTION

## PACKAGE DIAGRAM

### PCB mounting Series

#### TUBE PACKAGING DIMENSIONS (WITHOUT HEATSINK)

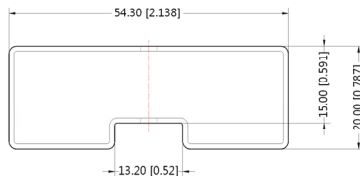

Note:  
 Unit :mm[inch]  
 General tolerances :±0.50[±0.020]  
 L=230[9.055] Tube Quantity:7 pcs  
 Inner carton(S): L\*W\*H=255\*170\*80  
 Outer carton(S): L\*W\*H=375\*280\*270, 6 inner cartons(S)

### Special Package Series (A2S/A4S)

#### PACKAGE DIAGRAM

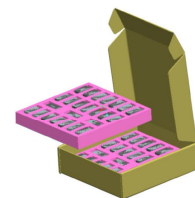

Note:  
 Unit:mm[inch]  
 Inner carton dimensions L\*W\*H=365\*350\*105  
 Packaging quantity : 48 PCS  
 Outer carton dimensions: L\*W\*H=390\*360\*245  
 Packaging quantity : 96 PCS

## TEST CONFIGURATIONS

### Input Reflected-Ripple Current Test Setup

Input reflected-ripple current is measured with an inductor Lin and Capacitor Cin to simulate the source impedance.

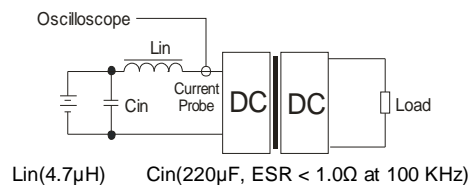

## DESIGN CONSIDERATIONS

### 1) Recommended circuit

All the URA\_(X)D-10WR2 & URB\_(X)D-10WR2 Series have been tested according to the following recommended test circuit before leaving the factory (see Figure 6).

If you want to further decrease the input/output ripple, you can increase a capacitance-values properly or choose capacitors with low ESR, but the total capacitance of the filter capacitor must not exceed the Max. Capacitive Load.

Cin: 10 $\mu$ F~47 $\mu$ F

Cout: 10 $\mu$ F

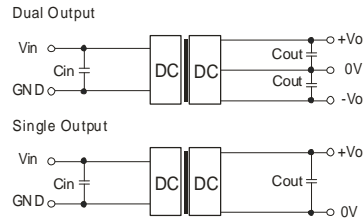

(Figure 6)

### 2) The modules can't be used in parallel or hot swap applications

Note:

1. Min. load shouldn't be less than 5%, otherwise ripple maybe increased dramatically. If the product operates under min. load, it may not be guaranteed to meet all specifications listed. Operation under minimum load will not damage the converter.
2. Recommended Dual output models unbalanced load is  $\leq \pm 5\%$ . If the product operates  $> \pm 5\%$ , it may not be guaranteed to meet all specifications listed. Please contact our technical support for more details.
3. Max. Capacitive Load is tested at input voltage range and full load.
4. All specifications measured at  $T_a=25^\circ\text{C}$ , humidity $<75\%$ , nominal input voltage and rated output load unless otherwise specified.
5. In this datasheet, all test methods are based on our corporate standards.
6. All characteristics are for listed models, and non-standard models may perform differently. Please contact our technical support for more details.
7. Please contact our technical support for any specific requirement.
8. Specifications of this product are subject to changes without prior notice.

### MORNSUN Science & Technology Co.,Ltd.

Address: No. 5, Kehui St. 1, Kehui development center, Science Ave., Guangzhou Science City, Luogang district, Guangzhou,P.R.China.

Tel: 86-20-38601850

Fax:86-20-38601272

E-mail: [info@mornsun.cn](mailto:info@mornsun.cn)

[Http://www.mornsun-power.com](http://www.mornsun-power.com)