

# Specification

## SSC-SAW8KG0B

# SAW8KG0B

## Description

This surface-mount LED comes in standard package dimension. It has a substrate made up of a molded plastic reflector sitting on top of a bent lead frame. The die is attached within the reflector Cavity and the cavity is encapsulated by silicone.

The package design coupled with careful selection of component materials allow these products to perform with high reliability.



# SAW8KG0B

## Features

- White colored SMT package.
- Pb-free Reflow Soldering
- Suitable for all SMT
- Lead Free and RoHS compliant

## Applications

- Interior lighting
- General lighting
- Indoor and out door displays
- Architectural / Decorative lighting

# Contents

- 1. Outline dimensions**
- 2. Characteristics of SAW8KG0B LED**
- 3. Characteristic diagrams**
- 4. Color & Binning**
- 5. Bin Code Description**
- 6. Labeling**
- 7. Packing**
- 8. Recommended solder pad**
- 9. Soldering**
- 10. Precaution for use**
- 11. Handling of Silicone Resin LEDs**

# 1. Outline dimensions

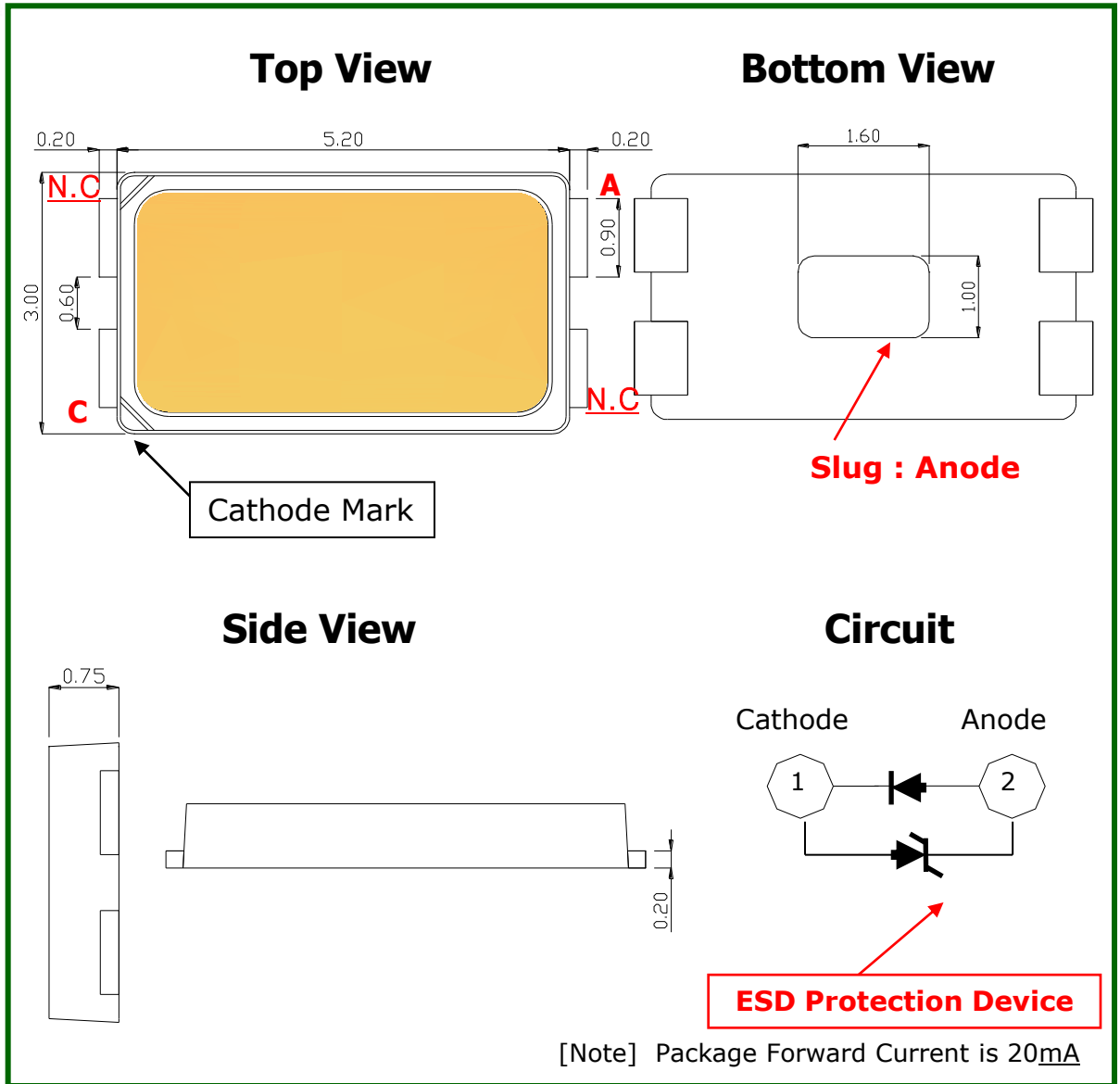

Notes :

- [1] All dimensions are in millimeters.
- [2] Scale : none
- [3] Undefined tolerance is  $\pm 0.1\text{mm}$

## 2. Characteristics of SAW8KG0B

(Ta=25°C)

### Electro-Optical characteristics

Parameter	Symbol	Condition	Min.	Typ.	Max.	Unit
<b>Forward Voltage*</b>	$V_F$	$I_F=20\text{mA}$	20.7	22	23	V
<b>Reverse Voltage</b>	$V_R$	$I_R=10\text{mA}$	0.7	-	-	V
<b>Luminous Intensity*<sup>[1]</sup> (3700~7000K)</b>	$I_v$	$I_F=20\text{mA}$	-	17.02 (52.8)	-	cd (lm)
<b>Luminous Intensity*<sup>[1]</sup> (2600~3700K)</b>	$I_v$	$I_F=20\text{mA}$	-	16.2 (50.1)	-	
<b>Color Correlated Temperature</b>	CCT	$I_F=20\text{mA}$	2,600	-	7,000	K
<b>Viewing Angle <sup>[2]</sup></b>	$2\theta_{1/2}$	$I_F=20\text{mA}$	-	115	-	deg.
<b>Color Rendering Index*</b>	Ra	$I_F=20\text{mA}$	80	82	90	-
<b>ESD (HBM)</b>		1.5kΩ;100 pF	5	-	-	KV
<b>Thermal resistance <sup>[3]</sup></b>	$R_{thJS}$	$I_F=20\text{mA}$	-	27	-	K/W

[1] The luminous intensity  $I_v$  was measured at the peak of the spatial pattern which may not be aligned with the mechanical axis of the LED package.

[2]  $2\theta_{1/2}$  is the off-axis where the luminous intensity is 1/2 of the peak intensity.

[3] Thermal resistance:  $R_{thJS}$  (Junction / solder)

\* Tolerance :  $V_F : \pm 0.4\text{V}$ ,  $I_v : \pm 7\%$ , Ra :  $\pm 2$ , x,y :  $\pm 0.01$

[Note] All measurements were made under the standardized environment of SSC.

### Absolute Maximum Ratings

Parameter	Symbol	Value	Unit
<b>Power Dissipation *<sup>[1]</sup></b>	$P_d$	0.58	W
<b>Forward Current</b>	$I_F$	25	mA
<b>Operating Temperature</b>	$T_{opr}$	-30~+85	°C
<b>Storage Temperature</b>	$T_{stg}$	-40~+100	°C
<b>Junction Temperature</b>	$T_j$	125	°C

[1] Care is to be taken that power dissipation does not exceed the absolute maximum rating of the product.

\* LED's properties might be different from suggested values like above and below tables if operation condition will be exceeded our parameter range.

### 3. Characteristic diagrams

#### Color Spectrum, Ta=25°C

1. **Cool white 4700 K~7000 K**
2. **Neutral white 3700 K~4700 K**
3. **Warm white 2600 K~3700 K**

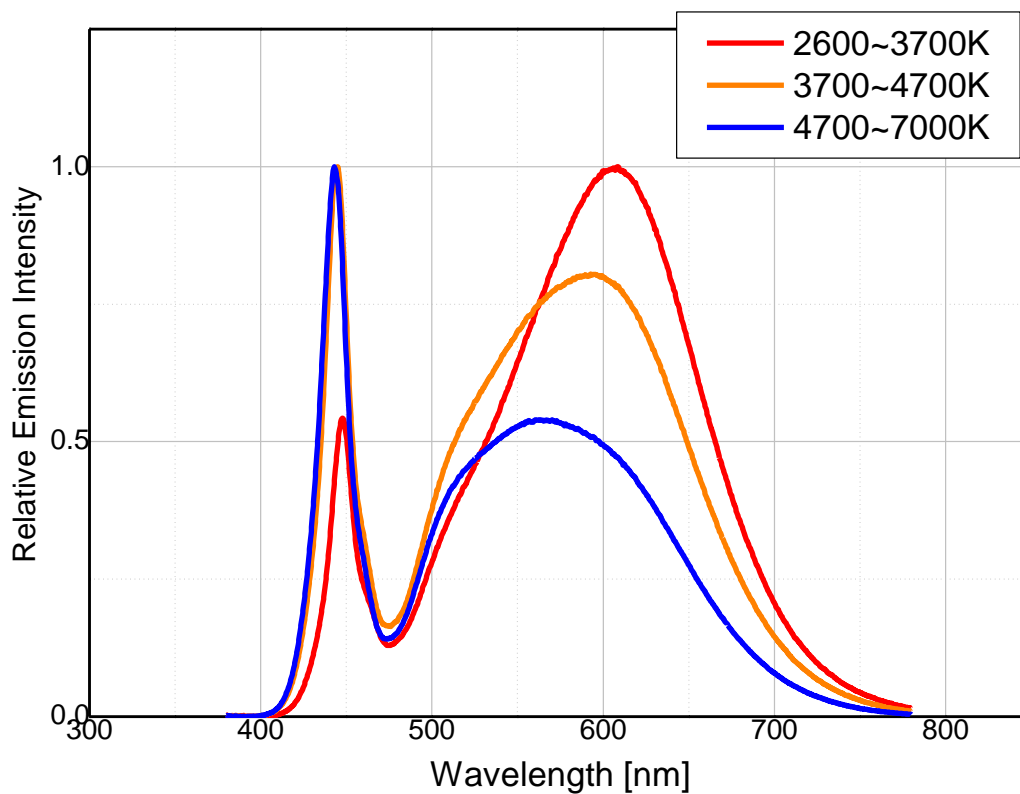

**Current – Voltage characteristics, Ta=25°C**

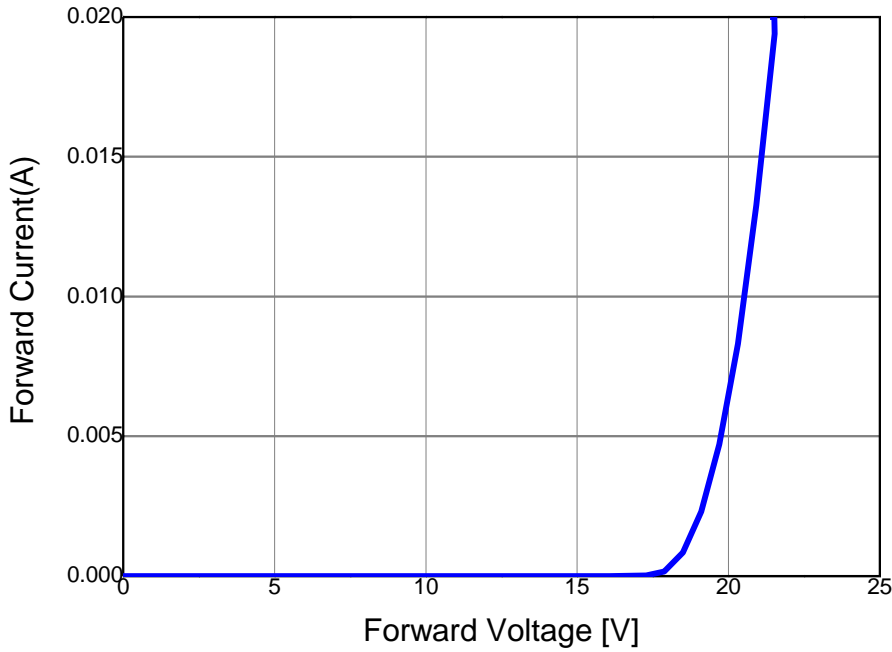

**Forward Current–Relative Luminous Intensity characteristics, Ta=25°C**

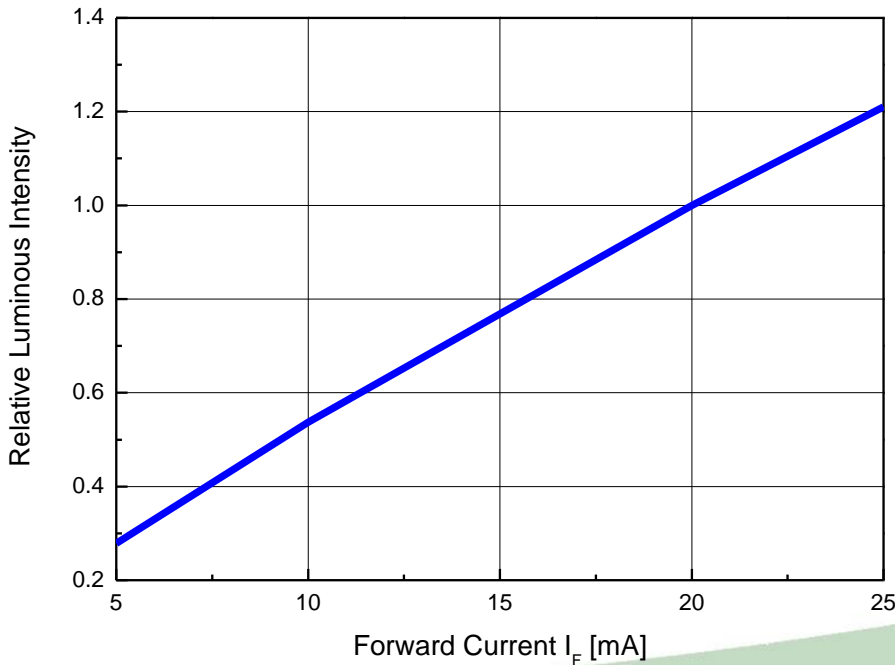

**Forward Voltage Shift - Junction Temperature characteristics, IF=20mA**

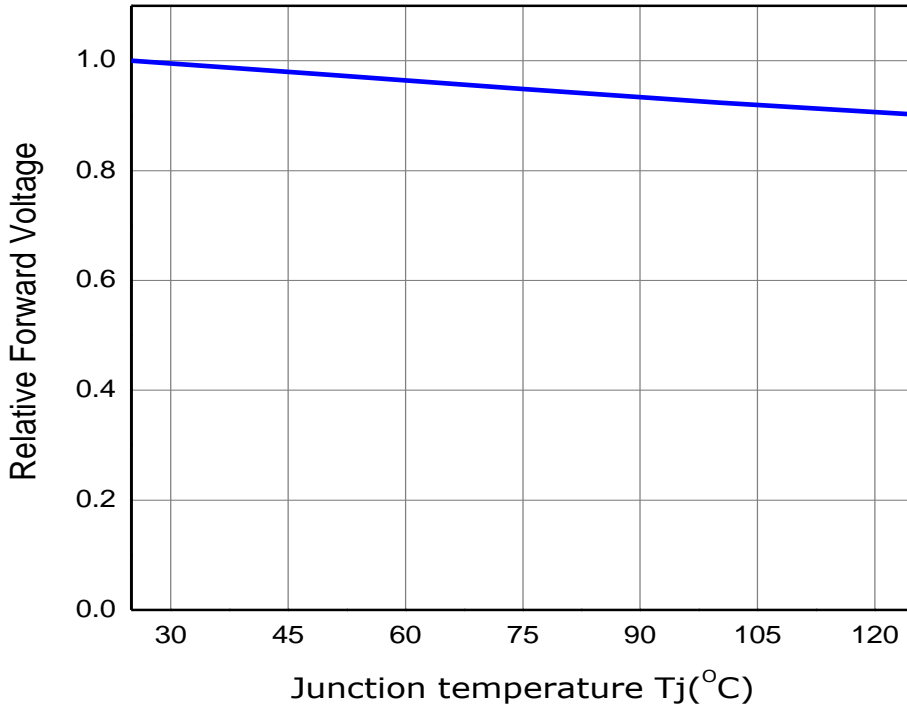

**Relative Light Output - Junction Temperature characteristics, IF=20mA**

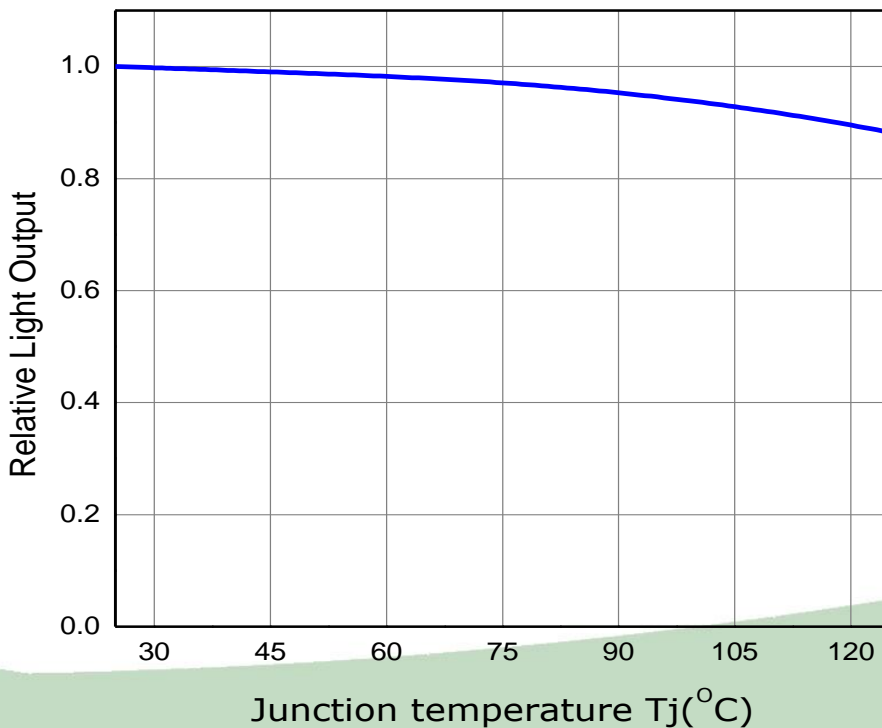



**Forward Current -Chromaticity Coordinate characteristics, Ta=25°C**

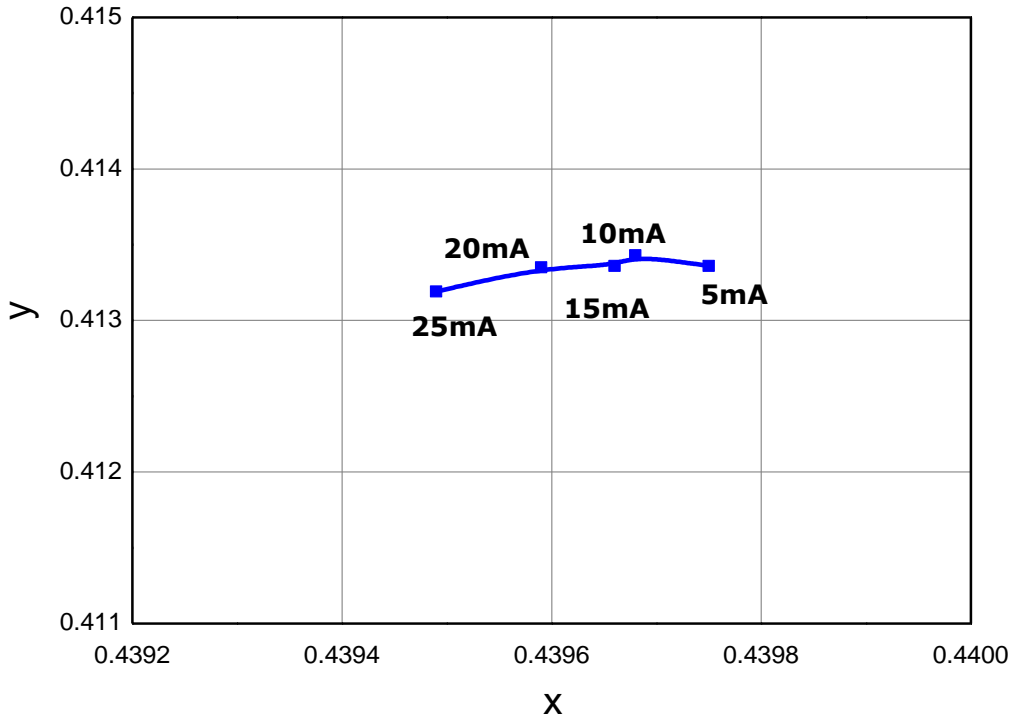

**Radiation pattern, IF=20mA**

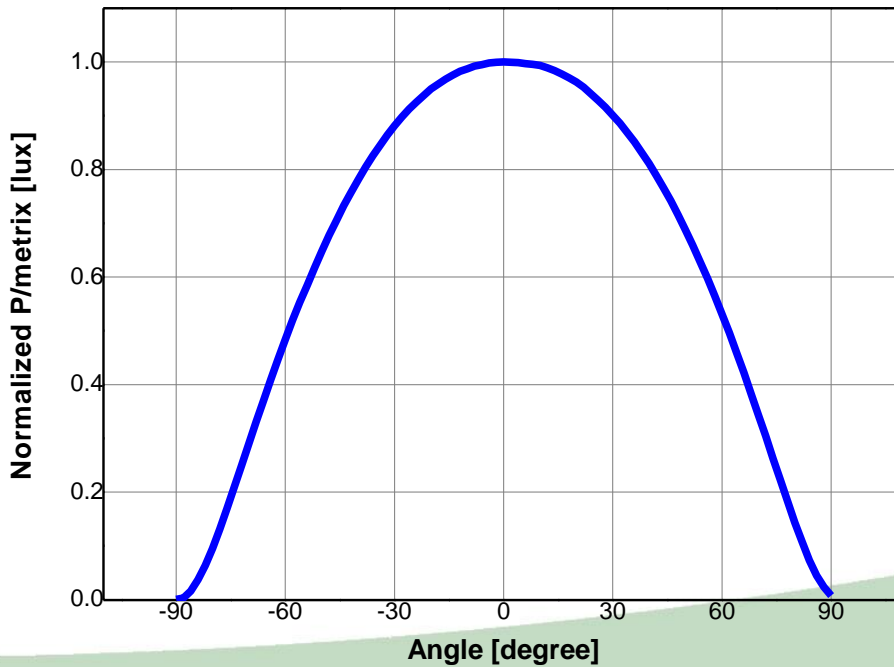

**Junction Temperature (°C) - Chromaticity Coordinate characteristics**

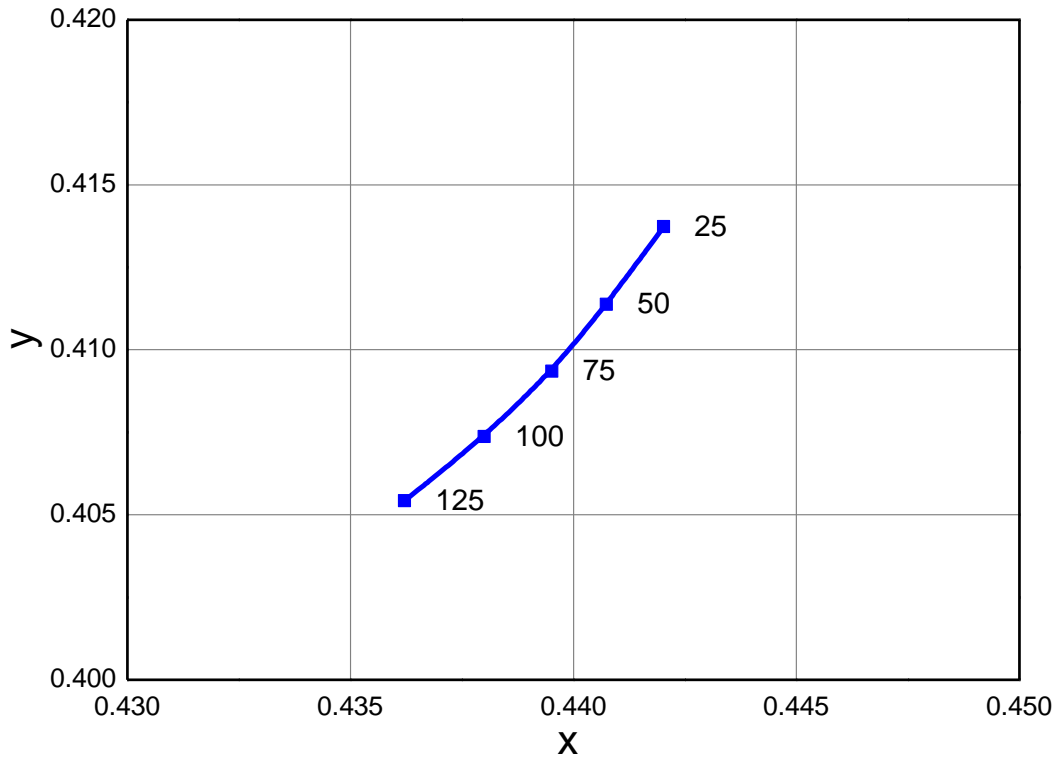

## 4. Color & binning

### 1. SAW8KGOB

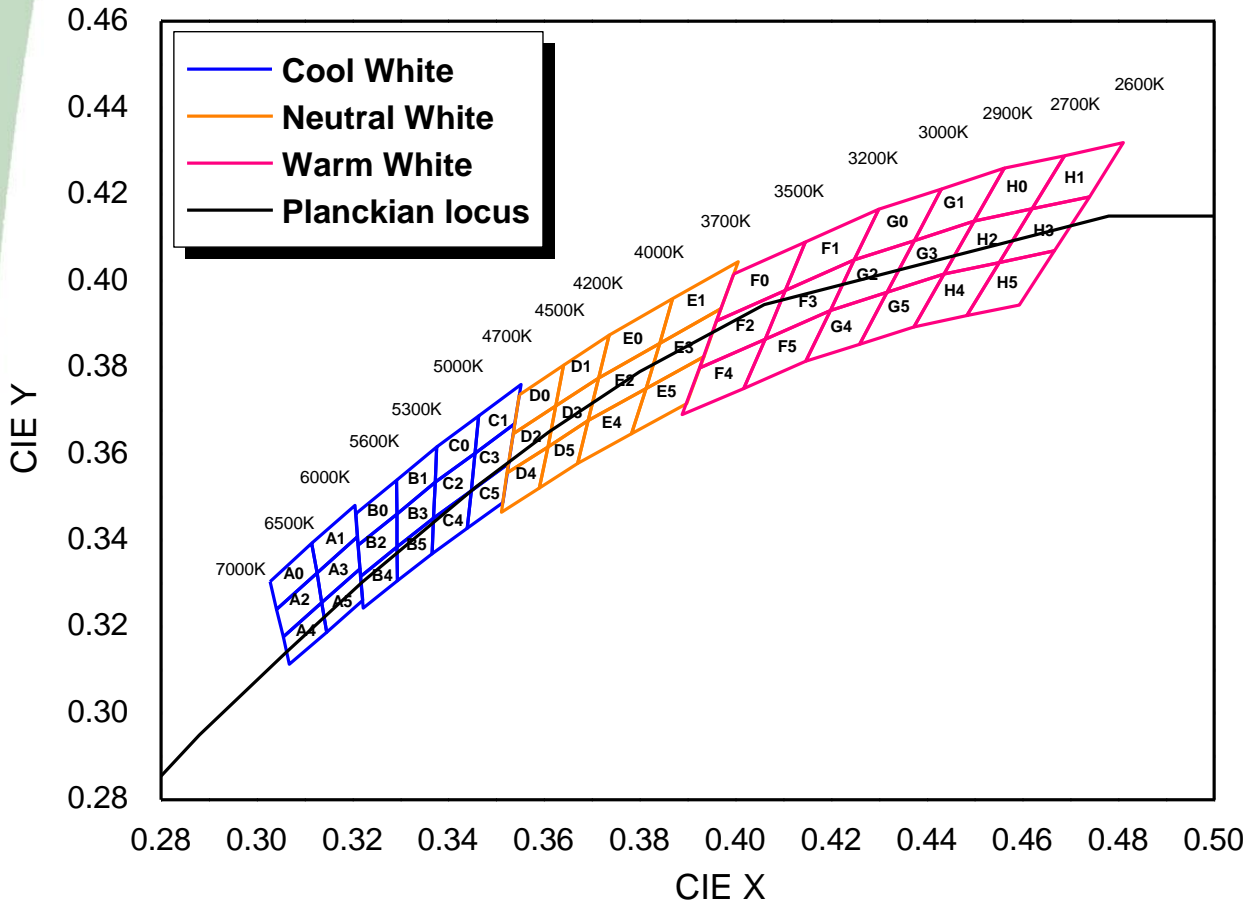

● COLOR RANK

<IF=20mA, Ta=25℃>

6500~7000K					
A0		A2		A4	
CIE X	CIE Y	CIE X	CIE Y	CIE X	CIE Y
0.3028	0.3304	0.3041	0.324	0.3055	0.3177
0.3041	0.324	0.3055	0.3177	0.3068	0.3113
0.3126	0.3324	0.3136	0.3256	0.3146	0.3187
0.3115	0.3393	0.3126	0.3324	0.3136	0.3256
6000~6500K					
A1		A3		A5	
CIE X	CIE Y	CIE X	CIE Y	CIE X	CIE Y
0.3115	0.3393	0.3126	0.3324	0.3136	0.3256
0.3126	0.3324	0.3136	0.3256	0.3146	0.3187
0.321	0.3408	0.3216	0.3334	0.3221	0.3261
0.3205	0.3481	0.321	0.3408	0.3216	0.3334
5600~6000K					
B0		B2		B4	
CIE X	CIE Y	CIE X	CIE Y	CIE X	CIE Y
0.3207	0.3462	0.3212	0.3389	0.3217	0.3316
0.3212	0.3389	0.3217	0.3316	0.3222	0.3243
0.3293	0.3461	0.3293	0.3384	0.3294	0.3306
0.3292	0.3539	0.3293	0.3461	0.3293	0.3384
5300~5600K					
B1		B3		B5	
CIE X	CIE Y	CIE X	CIE Y	CIE X	CIE Y
0.3292	0.3539	0.3293	0.3461	0.3293	0.3384
0.3293	0.3461	0.3293	0.3384	0.3294	0.3306
0.3373	0.3534	0.3369	0.3451	0.3366	0.3369
0.3376	0.3616	0.3373	0.3534	0.3369	0.3451

REV.04

August 2013

\* Measurement Uncertainty of the Color Coordinates : ± 0.01

www.seoulsemicon.com

서식번호 : SSC-QP-7-07-18 (Rev.00)

● COLOR RANK

<IF=20mA, Ta=25℃>

5000~5300K					
C0		C2		C4	
CIE X	CIE Y	CIE X	CIE Y	CIE X	CIE Y
0.3376	0.3616	0.3373	0.3534	0.3369	0.3451
0.3373	0.3534	0.3369	0.3451	0.3366	0.3369
0.3456	0.3601	0.3448	0.3514	0.344	0.3428
0.3463	0.3687	0.3456	0.3601	0.3448	0.3514
4700~5000K					
C1		C3		C5	
CIE X	CIE Y	CIE X	CIE Y	CIE X	CIE Y
0.3463	0.3687	0.3456	0.3601	0.3448	0.3514
0.3456	0.3601	0.3448	0.3514	0.344	0.3428
0.3539	0.3669	0.3526	0.3578	0.3514	0.3487
0.3552	0.376	0.3539	0.3669	0.3526	0.3578
4500~4700K					
D0		D2		D4	
CIE X	CIE Y	CIE X	CIE Y	CIE X	CIE Y
0.3548	0.3736	0.3536	0.3646	0.3523	0.3555
0.3536	0.3646	0.3523	0.3555	0.3511	0.3465
0.3625	0.3711	0.3608	0.3616	0.359	0.3521
0.3641	0.3804	0.3625	0.3711	0.3608	0.3616
4200~4500K					
D1		D3		D5	
CIE X	CIE Y	CIE X	CIE Y	CIE X	CIE Y
0.3641	0.3804	0.3625	0.3711	0.3608	0.3616
0.3625	0.3711	0.3608	0.3616	0.359	0.3521
0.3714	0.3775	0.3692	0.3677	0.367	0.3578
0.3736	0.3874	0.3714	0.3775	0.3692	0.3677

REV.04

August 2013

\* Measurement Uncertainty of the Color Coordinates : ± 0.01

www.seoulsemicon.com

서식번호 : SSC-QP-7-07-18 (Rev.00)

● COLOR RANK

<IF=20mA, Ta=25℃>

4000~4200K					
E0		E2		E4	
CIE X	CIE Y	CIE X	CIE Y	CIE X	CIE Y
0.3736	0.3874	0.3714	0.3775	0.3692	0.3677
0.3714	0.3775	0.3692	0.3677	0.367	0.3578
0.3842	0.3855	0.3813	0.3751	0.3783	0.3646
0.3869	0.3958	0.3842	0.3855	0.3813	0.3751
3700~4000K					
E1		E3		E5	
CIE X	CIE Y	CIE X	CIE Y	CIE X	CIE Y
0.3869	0.3958	0.3842	0.3855	0.3813	0.3751
0.3842	0.3855	0.3813	0.3751	0.3783	0.3646
0.397	0.3935	0.3934	0.3825	0.3898	0.3716
0.4006	0.4044	0.397	0.3935	0.3934	0.3825
3500~3700K					
F0		F2		F4	
CIE X	CIE Y	CIE X	CIE Y	CIE X	CIE Y
0.3996	0.4015	0.396	0.3907	0.3925	0.3798
0.396	0.3907	0.3925	0.3798	0.3889	0.369
0.4104	0.3978	0.4062	0.3865	0.4017	0.3751
0.4146	0.4089	0.4104	0.3978	0.4062	0.3865
3200~3500K					
F1		F3		F5	
CIE X	CIE Y	CIE X	CIE Y	CIE X	CIE Y
0.4146	0.4089	0.4104	0.3978	0.4062	0.3865
0.4104	0.3978	0.4062	0.3865	0.4017	0.3751
0.4248	0.4048	0.4198	0.3931	0.4147	0.3814
0.4299	0.4165	0.4248	0.4048	0.4198	0.3931

● COLOR RANK

<IF=20mA, Ta=25℃>

3000~3200K					
G0		G2		G4	
CIE X	CIE Y	CIE X	CIE Y	CIE X	CIE Y
0.4299	0.4165	0.4248	0.4048	0.4198	0.3931
0.4248	0.4048	0.4198	0.3931	0.4147	0.3814
0.4374	0.4093	0.4317	0.3973	0.4259	0.3853
0.443	0.4212	0.4374	0.4093	0.4317	0.3973
2900~3000K					
G1		G3		G5	
CIE X	CIE Y	CIE X	CIE Y	CIE X	CIE Y
0.443	0.4212	0.4374	0.4093	0.4317	0.3973
0.4374	0.4093	0.4317	0.3973	0.4259	0.3853
0.4499	0.4138	0.4436	0.4015	0.4373	0.3893
0.4562	0.426	0.4499	0.4138	0.4436	0.4015
2700~2900K					
H0		H2		H4	
CIE X	CIE Y	CIE X	CIE Y	CIE X	CIE Y
0.4562	0.426	0.4499	0.4138	0.4436	0.4015
0.4499	0.4138	0.4436	0.4015	0.4373	0.3893
0.462	0.4166	0.4551	0.4042	0.4483	0.3919
0.4687	0.4289	0.462	0.4166	0.4551	0.4042
2600~2700K					
H1		H3		H5	
CIE X	CIE Y	CIE X	CIE Y	CIE X	CIE Y
0.4687	0.4289	0.462	0.4166	0.4551	0.4042
0.462	0.4166	0.4551	0.4042	0.4483	0.3919
0.474	0.4194	0.4666	0.4069	0.4593	0.3944
0.481	0.4319	0.474	0.4194	0.4666	0.4069

REV.04

August 2013

\* Measurement Uncertainty of the Color Coordinates : ± 0.01

www.seoulsemicon.com

서식번호 : SSC-QP-7-07-18 (Rev.00)

## 5. Bin code description

### 1. Luminous Intensity Bins

- Luminous Intensity bin structure for Cool white, neutral white, warm white

• **Example**

BIN CODE : Y1G3B

└──────────┬──────────> Luminous Intensity bin

Bin Code	Luminous Intensity [cd] @ $I_F = 20\text{mA}$	*[note] Flux (lm)
W5	13.5~14.8	41.9~45.9
X8	14.8~16.1	45.9~49.9
Y1	16.1~17.4	49.9~53.9
Z4	17.4~19.0	53.9~58.9
J0	19.0~20.3	58.9~62.9

[Note] SSC sort the LED package according to the luminous intensity IV.  
(The lumen table is only for reference.)

### 2. Color Rank

white product tested and binned by x,y coordinates and CC

• **Example**

BIN CODE : Z4G3B

└──────────┬──────────> Color bin

[Note] Color Rank @  $I_F = 20\text{mA}$

### 3. Voltage Bins

• **Example**

BIN CODE : Z4G3B





└──────────┬──────────> Voltage bin

Bin Code	Min.	Max.
A	20.7	21.5
B	21.5	22.2
C	22.2	23.0

[Note] Forward Voltage (V) @  $I_F = 20\text{mA}$



## 6. Labeling

Rank : #1#2#3  
  
QUANTITY : **3,500**  
  
Lot No : #####  
  
SSC PART NUMBER : **SAW8KGOB**  
  

## 7. Packing

### Reel

RANK: XXXX  
 QUANTITY : XXXX  
 LOT NUMBER : XXXXXXXXXXXX  
 PART NUMBER : XXXXXXXX  
 SEOUL SEMICONDUCTOR CO., LTD.

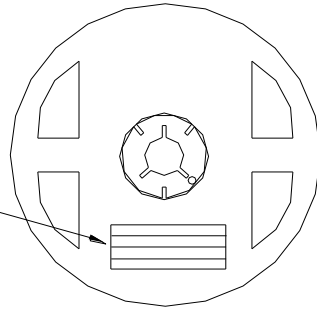

### Aluminum Vinyl Bag

RANK: XXXX  
 QUANTITY : XXXX  
 LOT NUMBER : XXXXXXXXXXXX  
 PART NUMBER : XXXXXXXX  
 SEOUL SEMICONDUCTOR CO., LTD.

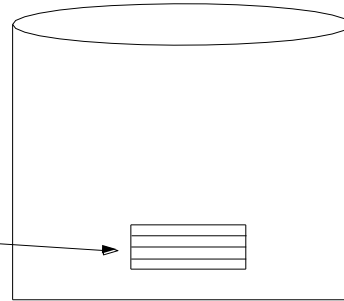

### Outer Box Structure

Material : Paper(SW3B(B))

TYPE	SIZE (mm)		
	a	b	c
7inch	245	220	142

#### ① SIDE

RANK: XXXX  
 QUANTITY : XXXX  
 LOT NUMBER : XXXXXXXXXXXX  
 PART NUMBER : XXXXXXXX  
 SEOUL SEMICONDUCTOR CO., LTD.

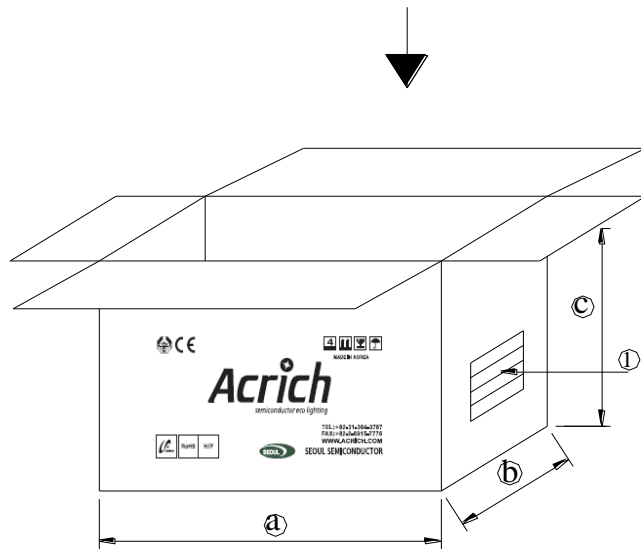

● **Reel Packing Structure**

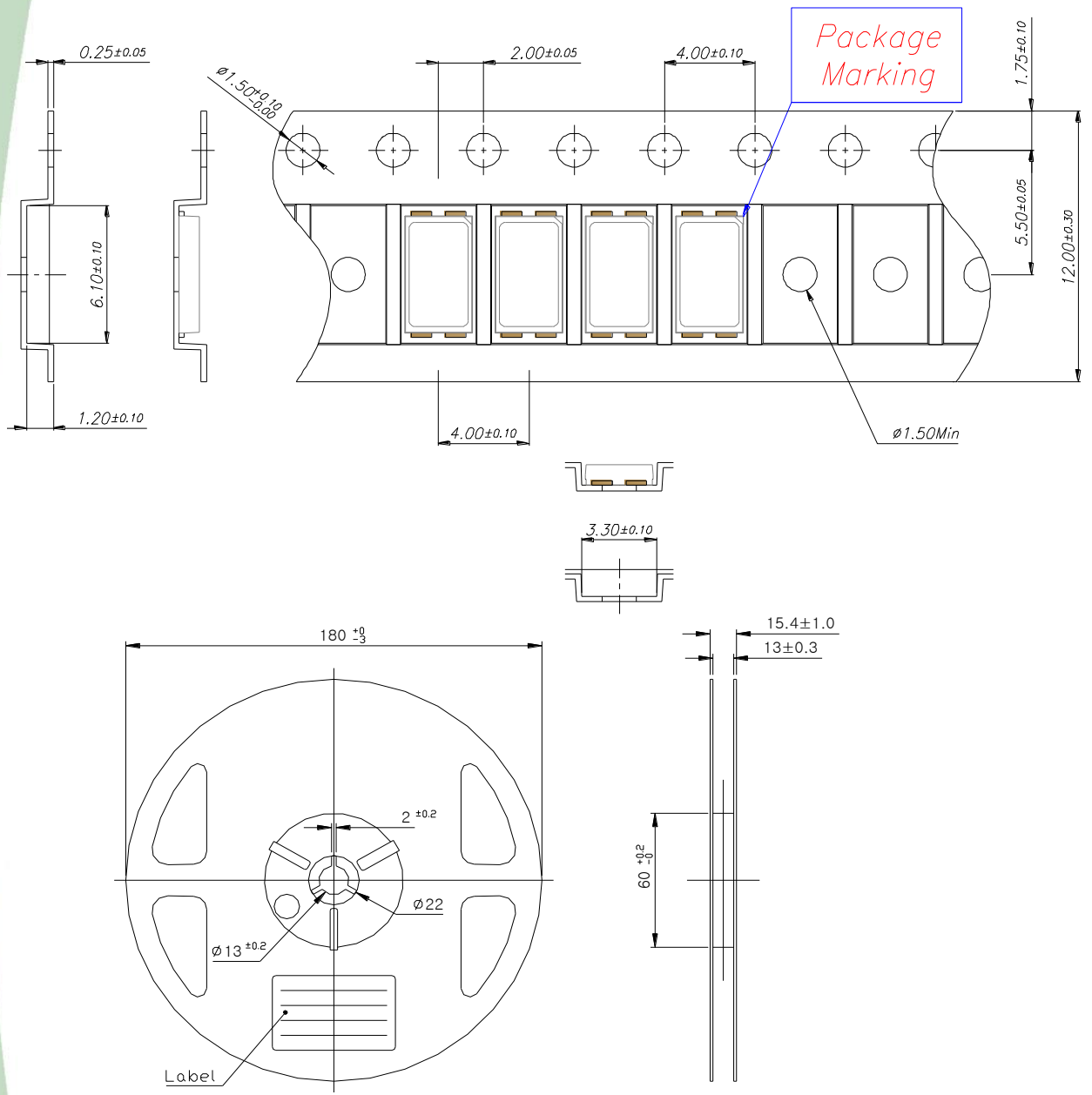

Notes :

( Tolerance:  $\pm 0.2$ , Unit: mm )

- [1] Quantity : 3,500pcs/Reel
- [2] Cumulative Tolerance : Cumulative Tolerance/10 pitches to be  $\pm 0.2$ mm
- [3] Adhesion Strength of Cover Tape : Adhesion strength to be 0.1-0.7N when the cover tape is turned off from the carrier tape at the angle of  $10^\circ$  to the carrier tape
- [4] Package : P/N, Manufacturing data Code No. and quantity to be indicated on a damp proof Package

REV.04  
August 2013

www.seoulsemicon.com

## 8. Recommended solder pad

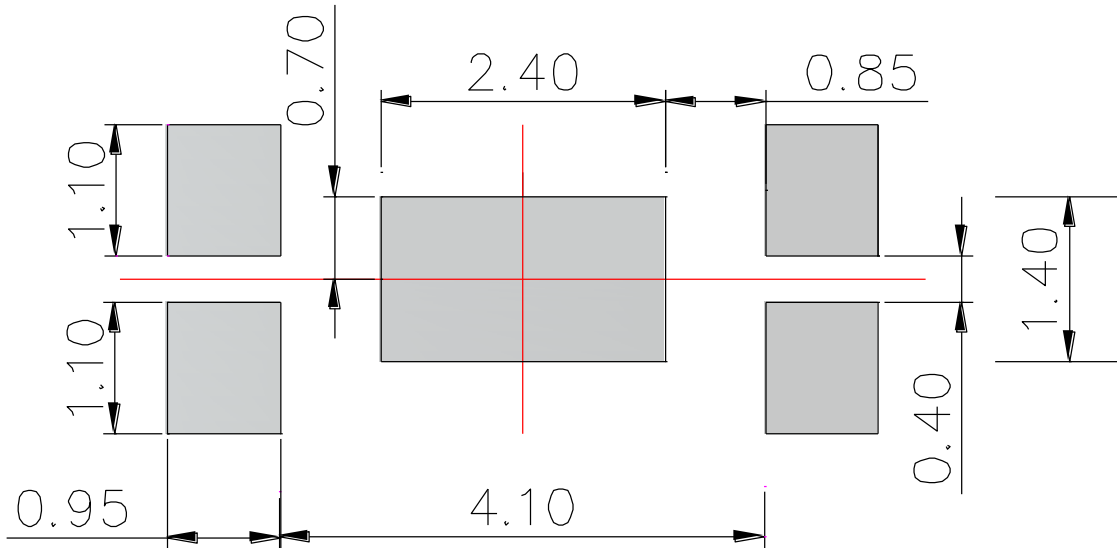

Notes :

- [1] All dimensions are in millimeters.
- [2] Scale : none
- [3] Undefined tolerance is  $\pm 0.1\text{mm}$   
This drawing without tolerances are for reference only.

## 9. Soldering

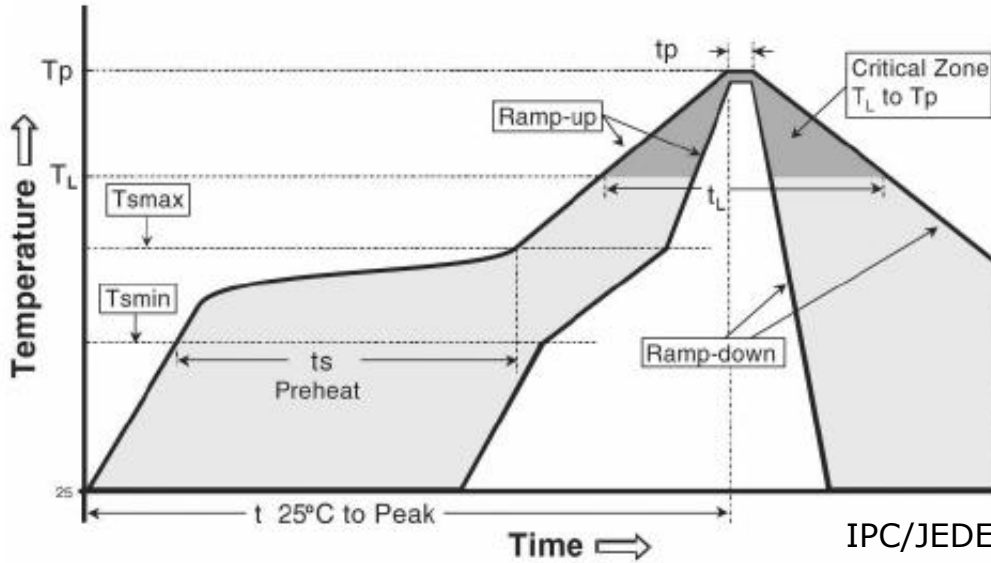

IPC/JEDEC J-STD-020

Profile Feature	Sn-Pb Eutectic Assembly	Pb-Free Assembly
<b>Average ramp-up rate (Tsmax to Tp)</b>	3° C/second max.	3° C/second max.
<b>Preheat</b> - Temperature Min (Tsmmin) - Temperature Max (Tsmmax) - Time (Tsmmin to Tsmmax) (ts)	100 °C 150 °C 60-120 seconds	150 °C 200 °C 60-180 seconds
Time maintained above: - Temperature (TL) - Time (tL)	183 °C 60-150 seconds	217 °C 60-150 seconds
Peak Temperature (Tp)	215°C	260°C
Time within 5°C of actual Peak Temperature (tp)2	10-30 seconds	20-40 seconds
Ramp-down Rate	6 °C/second max.	6 °C/second max.
Time 25°C to Peak Temperature	6 minutes max.	8 minutes max.

**\* Caution**

1. Reflow soldering is recommended not to be done more than two times. In the case of more than 24 hours passed soldering after first, LEDs will be damaged.
2. Repairs should not be done after the LEDs have been soldered. When repair is unavoidable, suitable tools must be used.
3. Die slug is to be soldered.
4. When soldering, do not put stress on the LEDs during heating.
5. After soldering, do not warp the circuit board.

REV.04

August 2013

www.seoulsemicon.com

## 10. Precaution for use

### (1) Storage

To avoid the moisture penetration, we recommend storing SSC LEDs in a dry box with a desiccant . The recommended storage temperature range is 5℃ to 30℃ and a maximum humidity of RH50%.

### (2) Use Precaution after Opening the Packaging

Use proper SMD techniques when the LED is to be soldered dipped as separation of the lens may affect the light output efficiency.

Pay attention to the following:

#### a. Recommend conditions after opening the package

- Sealing

- Temperature : 5 ~ 40℃ Humidity : less than RH30%

b. If the package has been opened more than 4 week(MSL\_2a) or the color of the desiccant changes, components should be dried for 10-12hr at 60±5℃

(3) Do not apply mechanical force or excess vibration during the cooling process to normal temperature after soldering.

(4) Do not rapidly cool device after soldering.

(5) Components should not be mounted on warped (non coplanar) portion of PCB.

(6) Radioactive exposure is not considered for the products listed here in.

(7) Gallium arsenide is used in some of the products listed in this publication. These products are dangerous if they are burned or shredded in the process of disposal. It is also dangerous to drink the liquid or inhale the gas generated by such products when chemically disposed of.

(8) This device should not be used in any type of fluid such as water, oil, organic solvent and etc. When washing is required, IPA (Isopropyl Alcohol) should be used.

(9) When the LEDs are in operation the maximum current should be decided after measuring the package temperature.

(10) LEDs must be stored properly to maintain the device. If the LEDs are stored for 3 months or more after being shipped from SSC, a sealed container with a nitrogen atmosphere should be used for storage.

(11) The appearance and specifications of the product may be modified for improvement without notice.

(12) Long time exposure of sunlight or occasional UV exposure will cause lens discoloration.

(13) VOCs (Volatile organic compounds) emitted from materials used in the construction of fixtures can penetrate silicone encapsulants of LEDs and discolor when exposed to heat and photonic energy. The result can be a significant loss of light output from the fixture.

Knowledge of the properties of the materials selected to be used in the construction of fixtures can help prevent these issues.

REV.04

August 2013

www.seoulsemicon.com

## 11. Handling of Silicone Resin LEDs

(1) During processing, mechanical stress on the surface should be minimized as much as possible. Sharp objects of all types should not be used to pierce the sealing compound.



(2) In general, LEDs should only be handled from the side. By the way, this also applies to LEDs without a silicone sealant, since the surface can also become scratched.

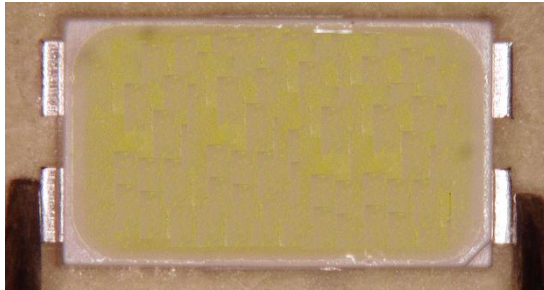

(3) When populating boards in SMT production, there are basically no restrictions regarding the form of the pick and place nozzle, except that mechanical pressure on the surface of the resin must be prevented.

This is assured by choosing a pick and place nozzle which is larger than the LED's reflector area.

(4) Silicone differs from materials conventionally used for the manufacturing of LEDs. These conditions must be considered during the handling of such devices. Compared to standard encapsulants, silicone is generally softer, and the surface is more likely to attract dust.

As mentioned previously, the increased sensitivity to dust requires special care during processing. In cases where a minimal level of dirt and dust particles cannot be guaranteed, a suitable cleaning solution must be applied to the surface after the soldering of components.

(5) SSC suggests using isopropyl alcohol for cleaning. In case other solvents are used, it must be assured that these solvents do not dissolve the package or resin.

Ultrasonic cleaning is not recommended. Ultrasonic cleaning may cause damage to the LED.

(6) Please do not mold this product into another resin (epoxy, urethane, etc) and do not handle this product with acid or sulfur material in sealed space.

(7) Avoid leaving fingerprints on silicone resin parts.

REV.04

August 2013

[www.seoulsemicon.com](http://www.seoulsemicon.com)