

IGBT SIP MODULE

Short Circuit Rated UltraFast IGBT

Features

- Short Circuit Rated UltraFast: Optimized for high operating frequencies >5.0 kHz , and Short Circuit Rated to 10μs @ 125°C, V<sub>GE</sub> = 15V
- Fully isolated printed circuit board mount package
- Switching-loss rating includes all "tail" losses
- HEXFRED™ soft ultrafast diodes
- Optimized for high operating frequency (over 5kHz)  
See Fig. 1 for Current vs. Frequency curve

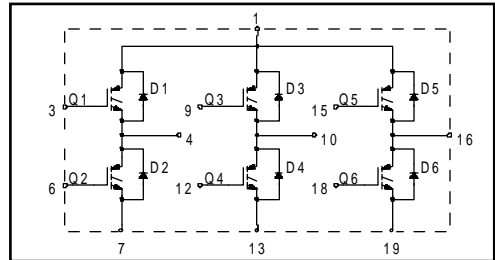

Product Summary

Output Current in a Typical 20 kHz Motor Drive

11 A<sub>RMS</sub> per phase (3.1 kW total) with T<sub>C</sub> = 90°C, T<sub>J</sub> = 125°C, Supply Voltage 360Vdc, Power Factor 0.8, Modulation Depth 115% (See Figure 1)

Description

The IGBT technology is the key to International Rectifier's advanced line of IMS (Insulated Metal Substrate) Power Modules. These modules are more efficient than comparable bipolar transistor modules, while at the same time having the simpler gate-drive requirements of the familiar power MOSFET. This superior technology has now been coupled to a state of the art materials system that maximizes power throughput with low thermal resistance. This package is highly suited to motor drive applications and where space is at a premium.

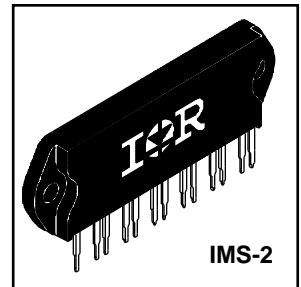

Absolute Maximum Ratings

	Parameter	Max.	Units
V <sub>CES</sub>	Collector-to-Emitter Voltage	600	V
I <sub>C</sub> @ T <sub>C</sub> = 25°C	Continuous Collector Current	24	A
I <sub>C</sub> @ T <sub>C</sub> = 100°C	Continuous Collector Current	13	
I <sub>CM</sub>	Pulsed Collector Current ①	48	
I <sub>LM</sub>	Clamped Inductive Load Current ②	48	
t <sub>sc</sub>	Short Circuit Withstand Time	9.3	μs
V <sub>GE</sub>	Gate-to-Emitter Voltage	±20	V
V <sub>ISOL</sub>	Isolation Voltage, any terminal to case, 1 min	2500	V <sub>RMS</sub>
P <sub>D</sub> @ T <sub>C</sub> = 25°C	Maximum Power Dissipation, each IGBT	63	W
P <sub>D</sub> @ T <sub>C</sub> = 100°C	Maximum Power Dissipation, each IGBT	25	
T <sub>J</sub>	Operating Junction and	-55 to +150	°C
T <sub>STG</sub>	Storage Temperature Range		
	Soldering Temperature, for 10 sec.	300 (0.063 in. (1.6mm) from case)	
	Mounting torque, 6-32 or M3 screw.	5-7 lbf•in ( 0.55-0.8 N•m)	

Thermal Resistance

	Parameter	Typ.	Max.	Units
R <sub>θJC</sub> (IGBT)	Junction-to-Case, each IGBT, one IGBT in conduction	—	2.0	°C/W
R <sub>θJC</sub> (DIODE)	Junction-to-Case, each diode, one diode in conduction	—	3.0	
R <sub>θCS</sub> (MODULE)	Case-to-Sink, flat, greased surface	0.10	—	
Wt	Weight of module	20 (0.7)	—	g (oz)

## Electrical Characteristics @ $T_J = 25^\circ\text{C}$ (unless otherwise specified)

	Parameter	Min.	Typ.	Max.	Units	Conditions
$V_{(BR)CES}$	Collector-to-Emitter Breakdown Voltage <sup>③</sup>	600	—	—	V	$V_{GE} = 0V, I_C = 250\mu A$
$\Delta V_{(BR)CES}/\Delta T_J$	Temperature Coeff. of Breakdown Voltage	—	0.63	—	V/ $^\circ\text{C}$	$V_{GE} = 0V, I_C = 1.0mA$
$V_{CE(on)}$	Collector-to-Emitter Saturation Voltage	—	1.80	2.3	V	$I_C = 13A$ $I_C = 24A$ $I_C = 13A, T_J = 150^\circ\text{C}$ $V_{GE} = 15V$ See Fig. 2, 5
		—	1.80	—		
		—	1.56	—		
$V_{GE(th)}$	Gate Threshold Voltage	3.0	—	6.0		$V_{CE} = V_{GE}, I_C = 250\mu A$
$\Delta V_{GE(th)}/\Delta T_J$	Temperature Coeff. of Threshold Voltage	—	-13	—	mV/ $^\circ\text{C}$	$V_{CE} = V_{GE}, I_C = 250\mu A$
$g_{fe}$	Forward Transconductance <sup>④</sup>	11	18	—	S	$V_{CE} = 100V, I_C = 10A$
$I_{CES}$	Zero Gate Voltage Collector Current	—	—	250	$\mu A$	$V_{GE} = 0V, V_{CE} = 600V$ $V_{GE} = 0V, V_{CE} = 600V, T_J = 150^\circ\text{C}$
		—	—	3500		
$V_{FM}$	Diode Forward Voltage Drop	—	1.3	1.7	V	$I_C = 15A$ $I_C = 15A, T_J = 150^\circ\text{C}$ See Fig. 13
		—	1.2	1.6		
$I_{GES}$	Gate-to-Emitter Leakage Current	—	—	$\pm 100$	nA	$V_{GE} = \pm 20V$

## Switching Characteristics @ $T_J = 25^\circ\text{C}$ (unless otherwise specified)

	Parameter	Min.	Typ.	Max.	Units	Conditions
$Q_g$	Total Gate Charge (turn-on)	—	110	170	nC	$I_C = 13A$ $V_{CC} = 400V$ $V_{GE} = 15V$ See Fig.8
$Q_{ge}$	Gate - Emitter Charge (turn-on)	—	14	21		
$Q_{gc}$	Gate - Collector Charge (turn-on)	—	49	74		
$t_{d(on)}$	Turn-On Delay Time	—	50	—	ns	$T_J = 25^\circ\text{C}$ $I_C = 13A, V_{CC} = 480V$ $V_{GE} = 15V, R_G = 10\Omega$
$t_r$	Rise Time	—	30	—		
$t_{d(off)}$	Turn-Off Delay Time	—	110	170		
$t_f$	Fall Time	—	91	140		
$E_{on}$	Turn-On Switching Loss	—	0.56	—	mJ	Energy losses include "tail" and diode reverse recovery See Fig. 9,10, 18
$E_{off}$	Turn-Off Switching Loss	—	0.28	—		
$E_{ts}$	Total Switching Loss	—	0.84	1.1		
$t_{sc}$	Short Circuit Withstand Time	10	—	—	$\mu s$	$V_{CC} = 360V, T_J = 125^\circ\text{C}$ $V_{GE} = 15V, R_G = 10\Omega, V_{CPK} < 500V$
$t_{d(on)}$	Turn-On Delay Time	—	47	—	ns	$T_J = 150^\circ\text{C}$ , $I_C = 13A, V_{CC} = 480V$ $V_{GE} = 15V, R_G = 10\Omega$ See Fig. 11,18 Energy losses include "tail" and diode reverse recovery
$t_r$	Rise Time	—	30	—		
$t_{d(off)}$	Turn-Off Delay Time	—	250	—		
$t_f$	Fall Time	—	150	—		
$E_{ts}$	Total Switching Loss	—	1.28	—	mJ	
$L_E$	Internal Emitter Inductance	—	7.5	—	nH	Measured 5mm from package
$C_{ies}$	Input Capacitance	—	1600	—	pF	$V_{GE} = 0V$ $V_{CC} = 30V$ $f = 1.0MHz$ See Fig. 7
$C_{oes}$	Output Capacitance	—	130	—		
$C_{res}$	Reverse Transfer Capacitance	—	55	—		
$t_{rr}$	Diode Reverse Recovery Time	—	42	60	ns	$T_J = 25^\circ\text{C}$ See Fig. 14 $T_J = 125^\circ\text{C}$ 14
		—	74	120		
$I_{rr}$	Diode Peak Reverse Recovery Current	—	4.0	6.0	A	$T_J = 25^\circ\text{C}$ See Fig. 15 $T_J = 125^\circ\text{C}$ 15
		—	6.5	10		
$Q_{rr}$	Diode Reverse Recovery Charge	—	80	180	nC	$T_J = 25^\circ\text{C}$ See Fig. 16 $T_J = 125^\circ\text{C}$ 16
		—	220	600		
$di_{(rec)M}/dt$	Diode Peak Rate of Fall of Recovery During $t_b$	—	188	—	A/ $\mu s$	$T_J = 25^\circ\text{C}$ See Fig. 17 $T_J = 125^\circ\text{C}$ 17
		—	160	—		

$I_F = 15A$   
 $V_R = 200V$   
 $di/dt = 200A/\mu s$

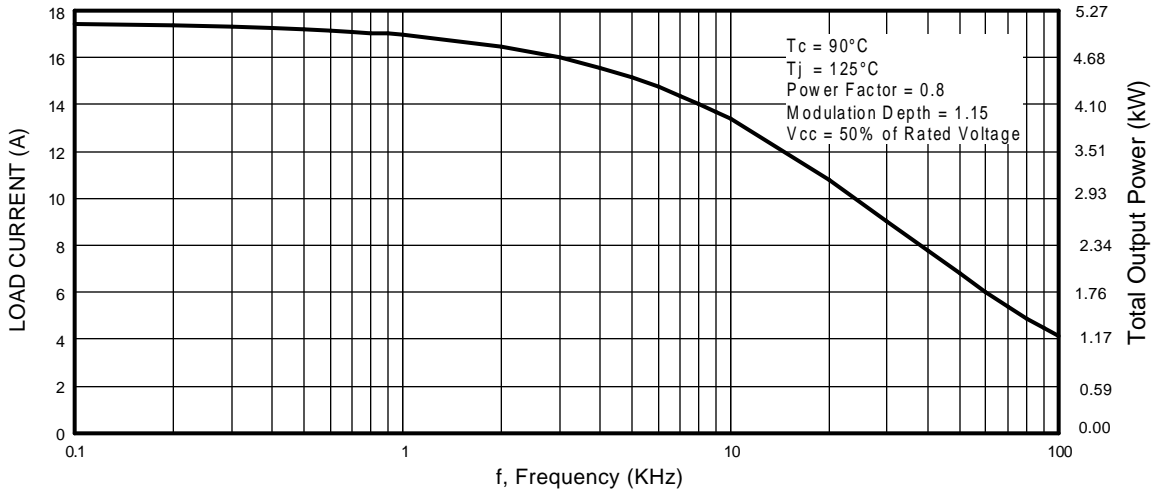

**Fig. 1** - Typical Load Current vs. Frequency  
(Load Current =  $I_{RMS}$  of fundamental)

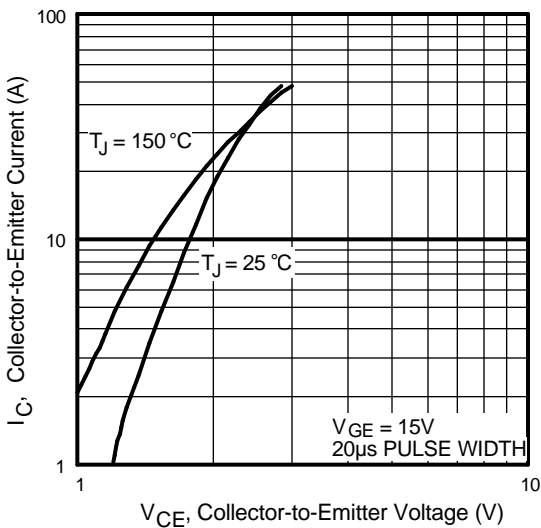

**Fig. 2** - Typical Output Characteristics

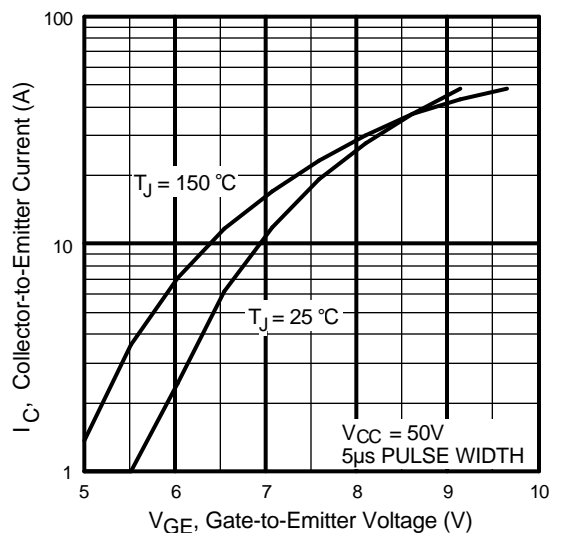

**Fig. 3** - Typical Transfer Characteristics

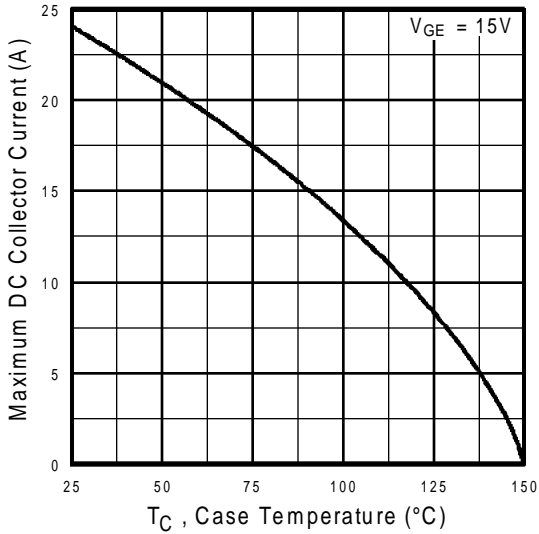

**Fig. 4 - Maximum Collector Current vs. Case Temperature**

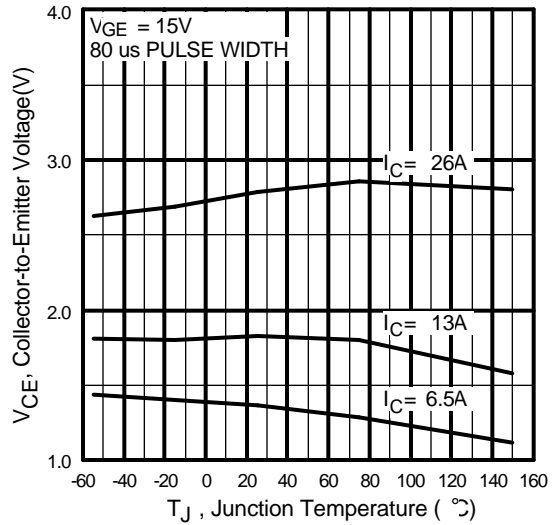

**Fig. 5 - Typical Collector-to-Emitter Voltage vs. Junction Temperature**

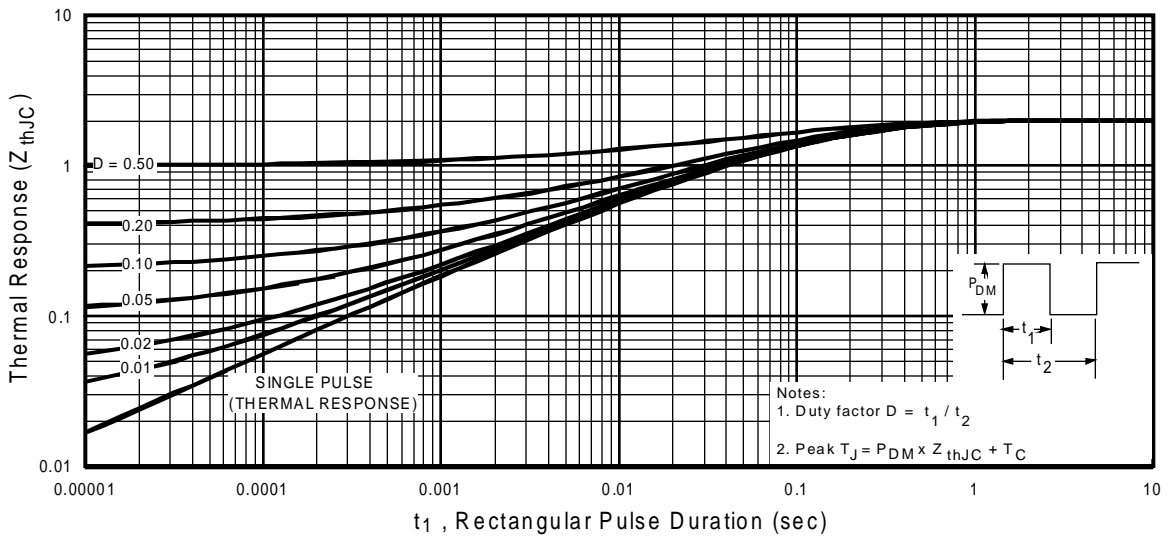

**Fig. 6 - Maximum IGBT Effective Transient Thermal Impedance, Junction-to-Case**

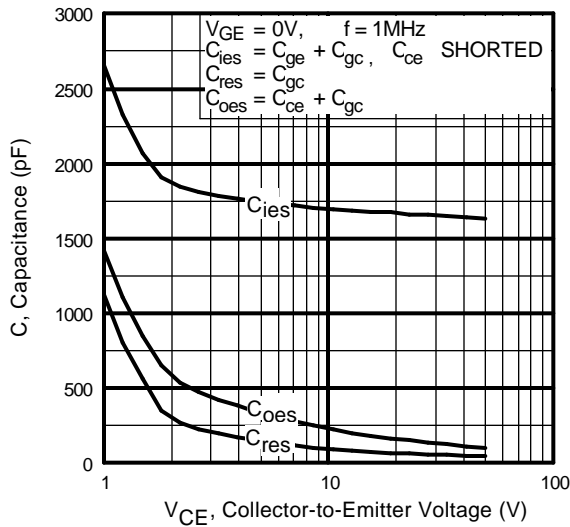

**Fig. 7** - Typical Capacitance vs. Collector-to-Emitter Voltage

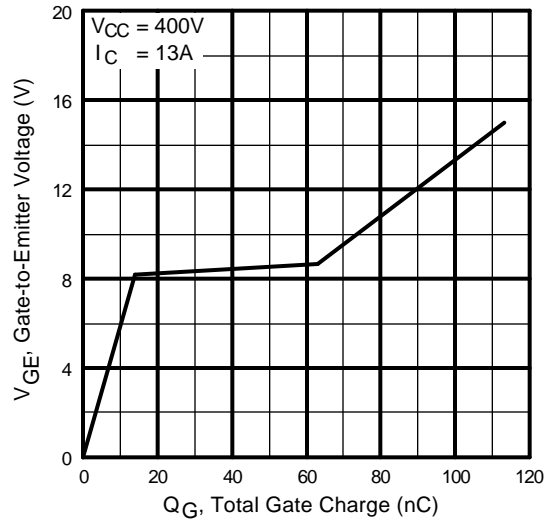

**Fig. 8** - Typical Gate Charge vs. Gate-to-Emitter Voltage

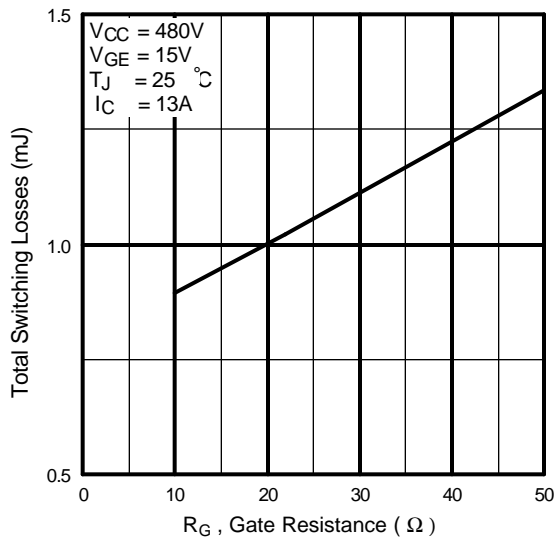

**Fig. 9** - Typical Switching Losses vs. Gate Resistance

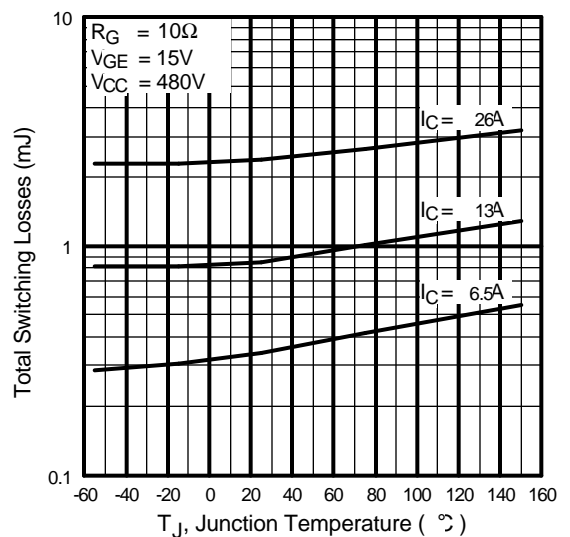

**Fig. 10** - Typical Switching Losses vs. Junction Temperature

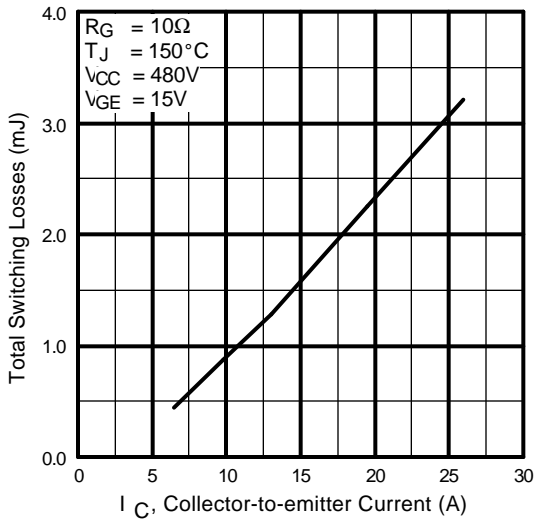

**Fig. 11** - Typical Switching Losses vs. Collector-to-Emitter Current

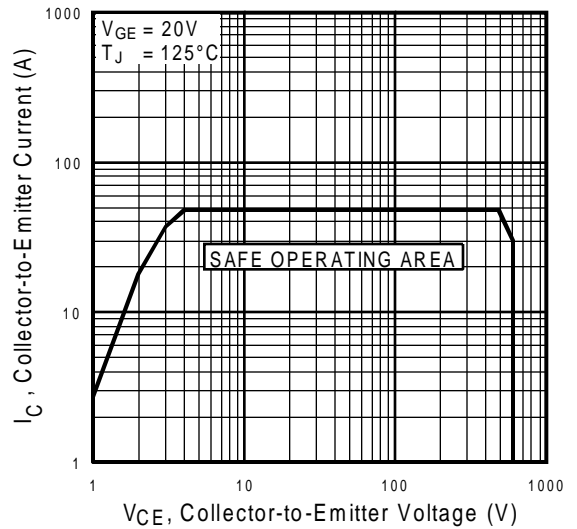

**Fig. 12** - Turn-Off SOA

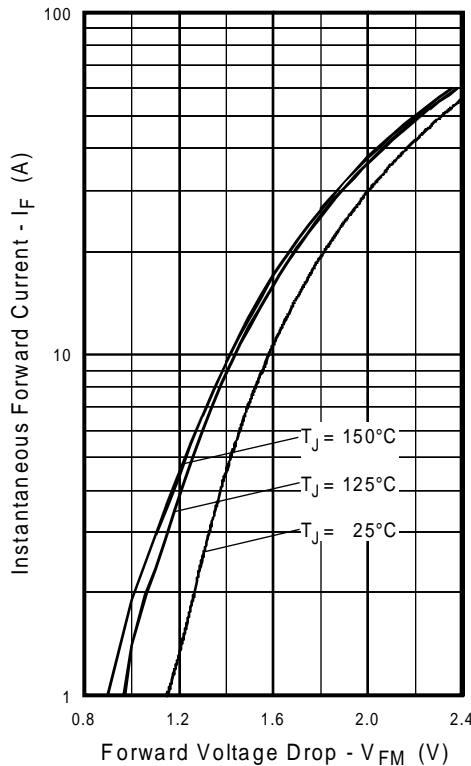

**Fig. 13** - Maximum Forward Voltage Drop vs. Instantaneous Forward Current

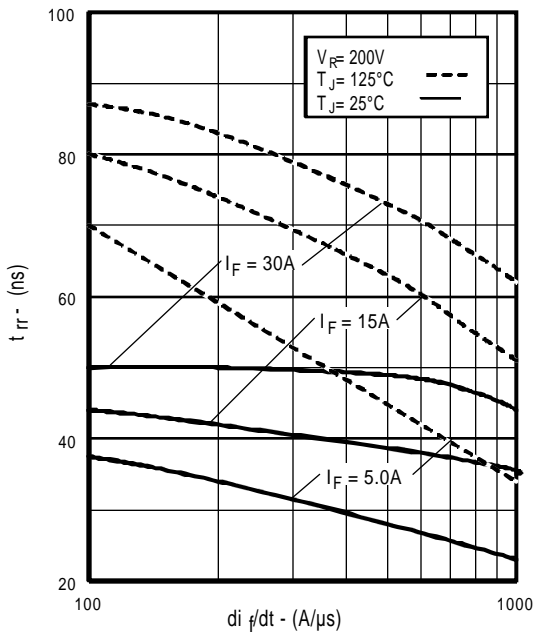

**Fig. 14** - Typical Reverse Recovery vs.  $di_f/dt$

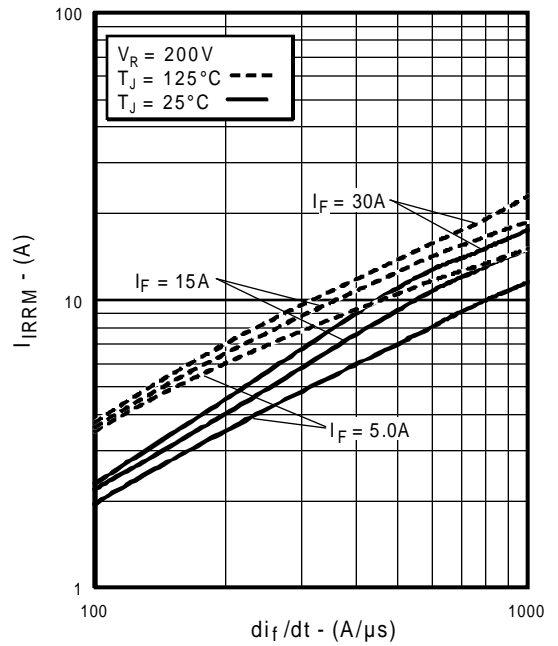

**Fig. 15** - Typical Recovery Current vs.  $di_f/dt$

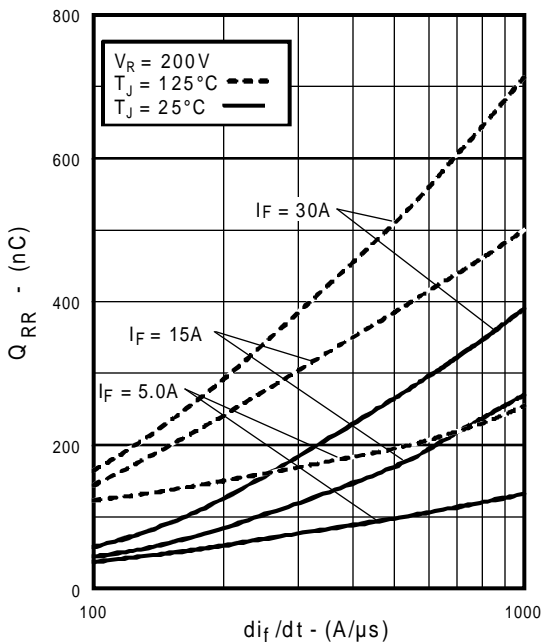

**Fig. 16** - Typical Stored Charge vs.  $di_f/dt$

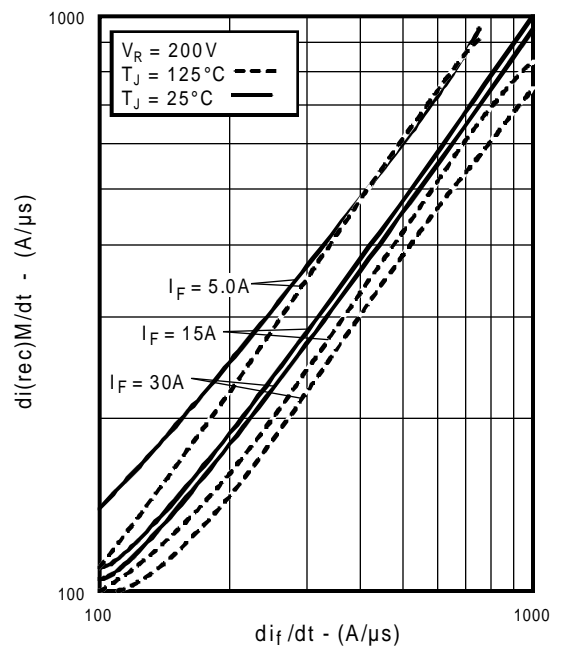

**Fig. 17** - Typical  $di_{(rec)M}/dt$  vs.  $di_f/dt$

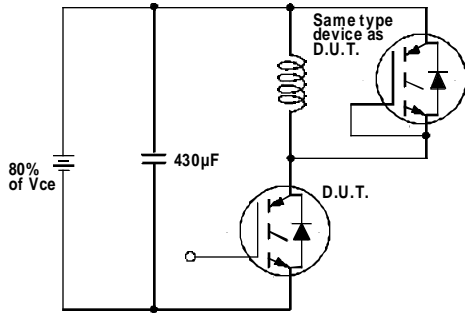

**Fig. 18a** - Test Circuit for Measurement of  $I_{LM}$ ,  $E_{on}$ ,  $E_{off}(\text{diode})$ ,  $t_{rr}$ ,  $Q_{rr}$ ,  $I_{rr}$ ,  $t_{d(on)}$ ,  $t_r$ ,  $t_{d(off)}$ ,  $t_f$

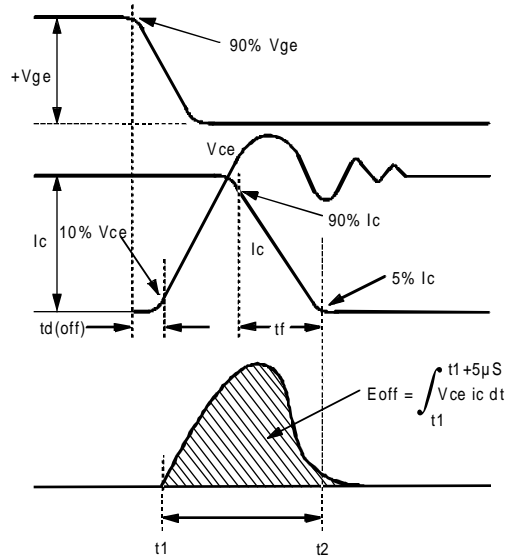

**Fig. 18b** - Test Waveforms for Circuit of Fig. 18a, Defining  $E_{off}$ ,  $t_{d(off)}$ ,  $t_f$

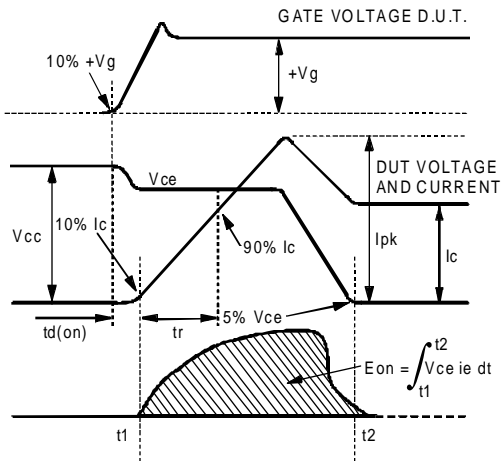

**Fig. 18c** - Test Waveforms for Circuit of Fig. 18a, Defining  $E_{on}$ ,  $t_{d(on)}$ ,  $t_r$

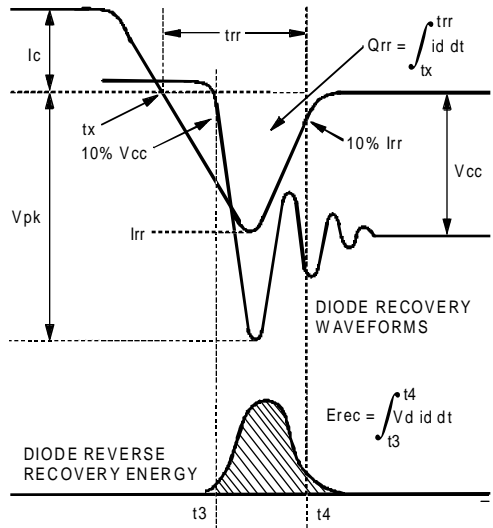

**Fig. 18d** - Test Waveforms for Circuit of Fig. 18a, Defining  $E_{rec}$ ,  $t_{rr}$ ,  $Q_{rr}$ ,  $I_{rr}$





Figure 18e. Macro Waveforms for Figure 18a's Test Circuit

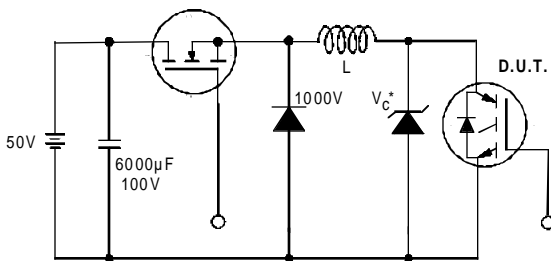

Figure 19. Clamped Inductive Load Test Circuit

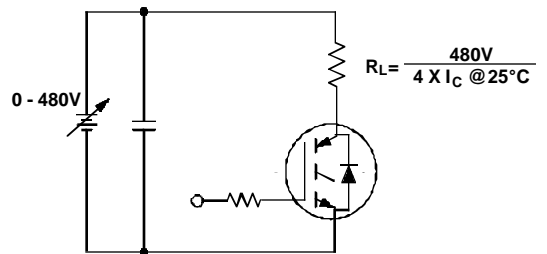

Figure 20. Pulsed Collector Current Test Circuit

## Notes:

- ① Repetitive rating:  $V_{GE}=20V$ ; pulse width limited by maximum junction temperature (figure 20)
- ②  $V_{CC}=80\%(V_{CES})$ ,  $V_{GE}=20V$ ,  $L=10\mu H$ ,  $R_G = 10\Omega$  (Figure 19)
- ③ Pulse width  $\leq 80\mu s$ ; duty factor  $\leq 0.1\%$ .
- ④ Pulse width  $5.0\mu s$ , single shot.

## Case Outline — IMS-2

