



October 2014

# KA78RM33R Low Dropout Voltage Regulator

## Features

- 0.5 A / 3.3 V Output Low-Dropout Voltage Regulator
- Low-Dropout Voltage (Max: 0.6 V)
- Over-Current Protection, Thermal Shutdown
- SOA Protection, Short-Circuit Protection

## Description

The KA78RM33R is a low-dropout voltage regulator suitable for various electronic equipment. It provides constant voltage power source with surface-mount type package (DPAK). The dropout voltage is below 0.6 V in full-rated current 0.5 A. This regulator has over-current protection, thermal shut-down and the SOA (Safe operating Area) protection.

DPAK

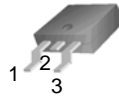

1.  $V_{IN}$  2. GND 3.  $V_{OUT}$

## Ordering Information

Part Number	Operating Temperature Range	Top Mark	Package	Packing Method
KA78RM33RTF	-40 to +125°C	KA78RM33	DPAK	Tape and Reel
KA78RM33RTM		KA78RM33	DPAK	Tape and Reel

\* Refer to below unit orientation figure for TM / TF suffix packing.

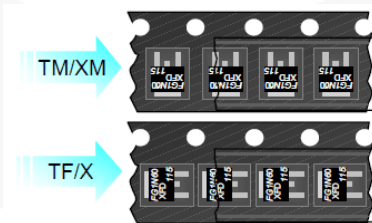

KA78RM33R — Low Dropout Voltage Regulator

### Block Diagram

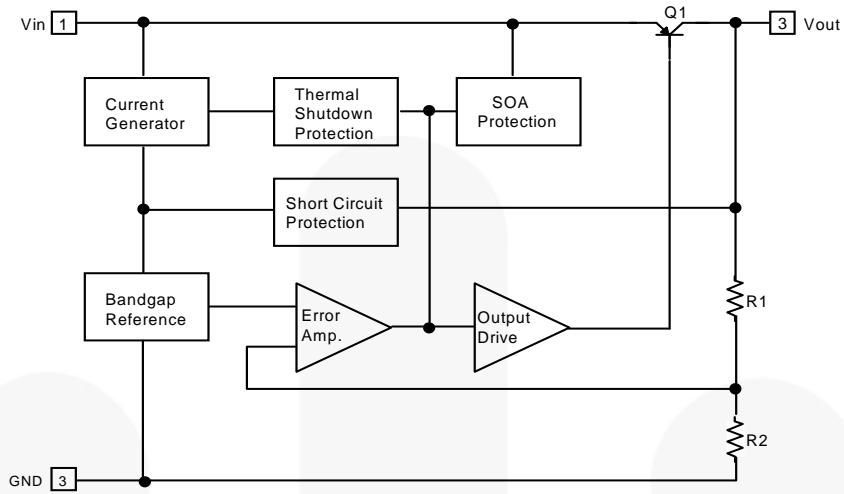

Figure 1. Block Diagram

### Typical Application

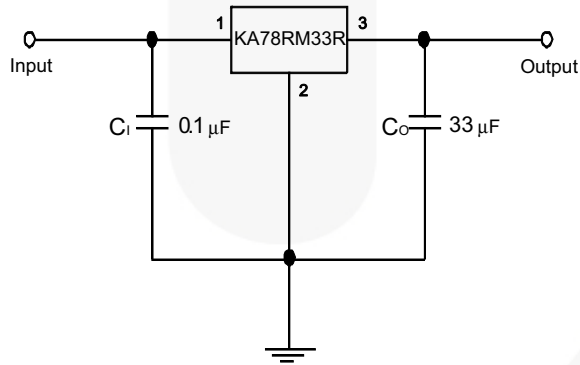

Figure 2. DC Parameters

**Notes:**

1.  $C_i$  is required if the regulator is located an appreciable distance from power supply filter.
2.  $C_o$  improves stability and transient response. Refer to the figure 12 for ESR values of capacitors.



## Absolute Maximum Ratings

Stresses exceeding the absolute maximum ratings may damage the device. The device may not function or be operable above the recommended operating conditions and stressing the parts to these levels is not recommended. In addition, extended exposure to stresses above the recommended operating conditions may affect device reliability. The absolute maximum ratings are stress ratings only. Values are at  $T_A = 25^\circ\text{C}$  unless otherwise noted.

Symbol	Parameter	Value	Remark	Unit
$V_{IN}$	Input Voltage	20		V
$I_O$	Output Current	0.5		A
$R_{\theta JA}$	Thermal Resistance Junction-Air	110	No Heatsink	$^\circ\text{C}/\text{W}$
$P_D$	Power Dissipation	Internally limited		
$T_J$	Junction Temperature	150		$^\circ\text{C}$
$T_{OPR}$	Operating Temperature	-40 to +125		$^\circ\text{C}$

## Electrical Characteristics

Values are at  $T_A = 25^\circ\text{C}$ ,  $V_{IN} = 5\text{ V}$ ,  $I_O = 0.25\text{ A}$  unless otherwise specified.

Symbol	Parameter	Conditions	Min.	Typ.	Max.	Unit
$V_{OUT}$	Output Voltage	$I_O = 10\text{ mA}$	3.22	3.30	3.38	V
$R_{LOAD}$	Load Regulation	$5\text{ mA} < I_O < 0.5\text{ A}$		2.0	20	mV
$R_{LINE}$	Line Regulation	$4.3\text{ V} < V_{IN} < 16\text{ V}$		2.0	20	mV
$R_R$	Ripple Rejection Ratio	$f = 120\text{ Hz}$ , $V_{IN} = 5\text{ V} \pm 0.5\text{ V}_{RMS}$	55			dB
$V_{DROP}$	Dropout Voltage	$I_O = 0.5\text{ A}$			0.6	V
$I_Q$	Quiescent Current	$I_O = 0\text{ A}$		5.0	10	mA
$I_{PK}$	Peak Current	$V_{IN} = 5\text{ V}$	0.5	1.0		A
$V_N$	Output Noise Voltage	$10\text{ Hz} < f < 100\text{ kHz}$		50		$\mu\text{V}_{RMS}$
$\Delta V_{OUT}/\Delta T$	Temperature Coefficient of Output Voltage	$-40^\circ\text{C} < T_J < 125^\circ\text{C}$ , $I_O = 100\text{ mA}$		-0.2		$\text{mV}/^\circ\text{C}$

## Typical Performance Characteristics

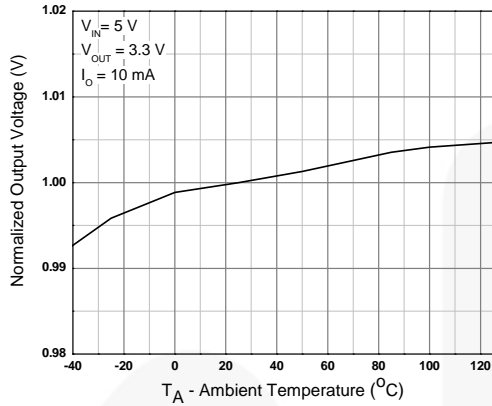

Figure 3. Normalized Output Voltage

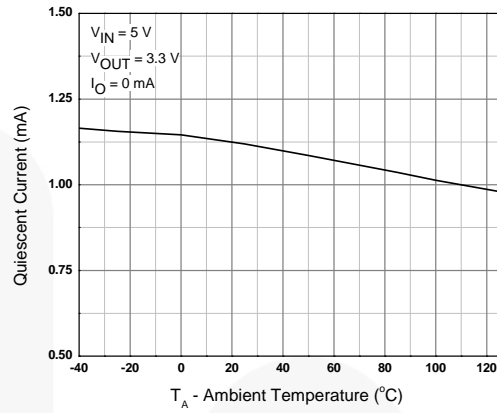

Figure 4. Quiescent vs. Temperature

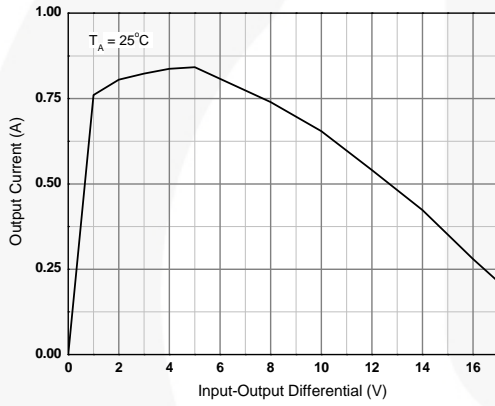

Figure 5. Peak Output Current

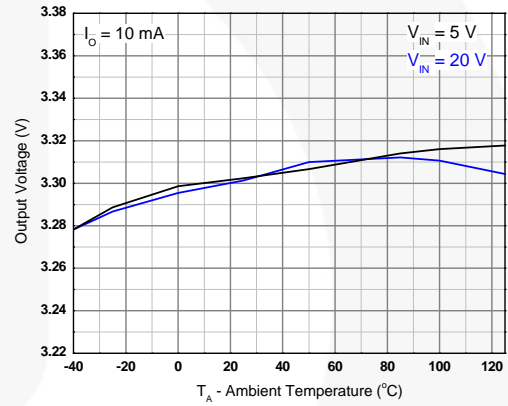

Figure 6. Output Voltage vs. Temperature

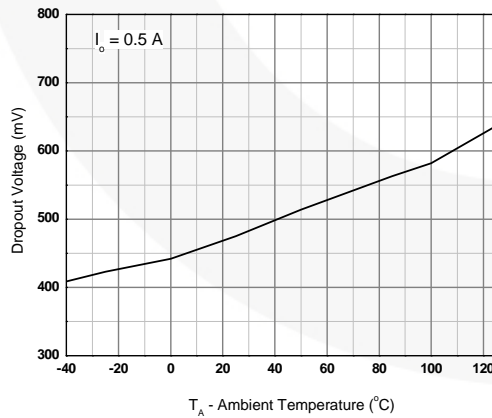

Figure 7. Dropout Voltage vs. Temperature

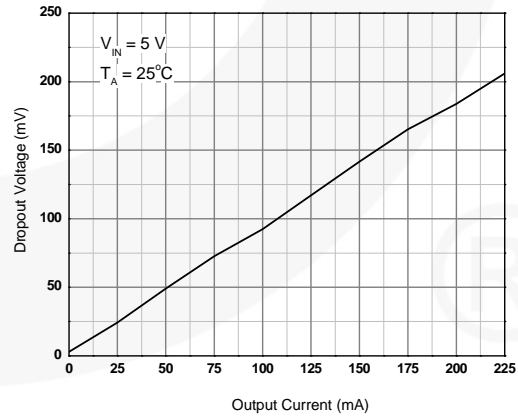

Figure 8. Dropout Voltage vs. Output Current

Typical Performance Characteristics (Continued)

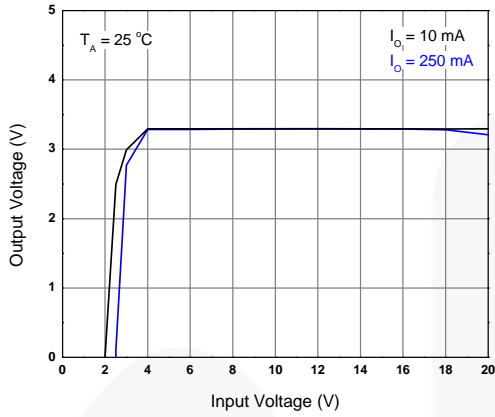

Figure 9. Output Voltage vs. Input Voltage

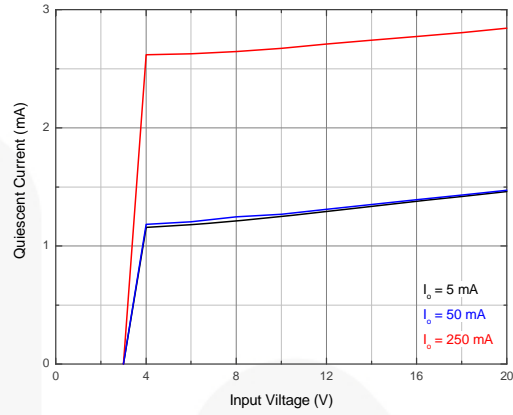

Figure 10. Quiescent Current vs. Input Voltage

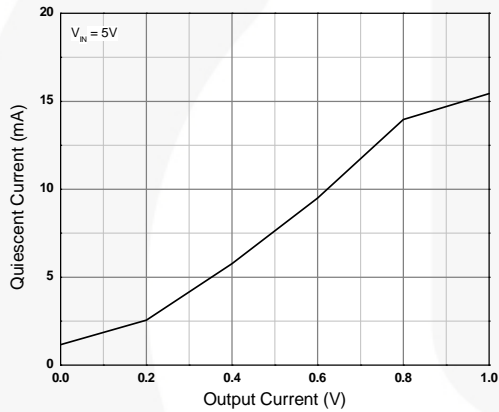

Figure 11. Quiescent Current vs. Output Current

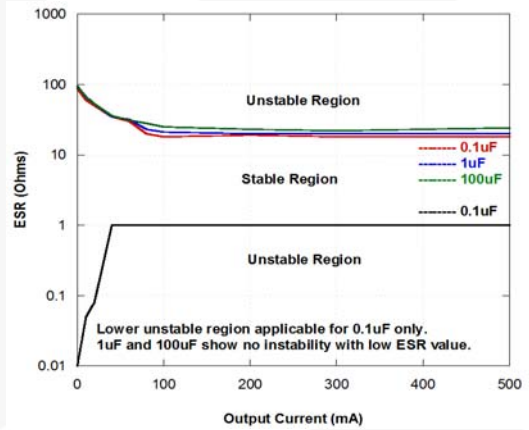
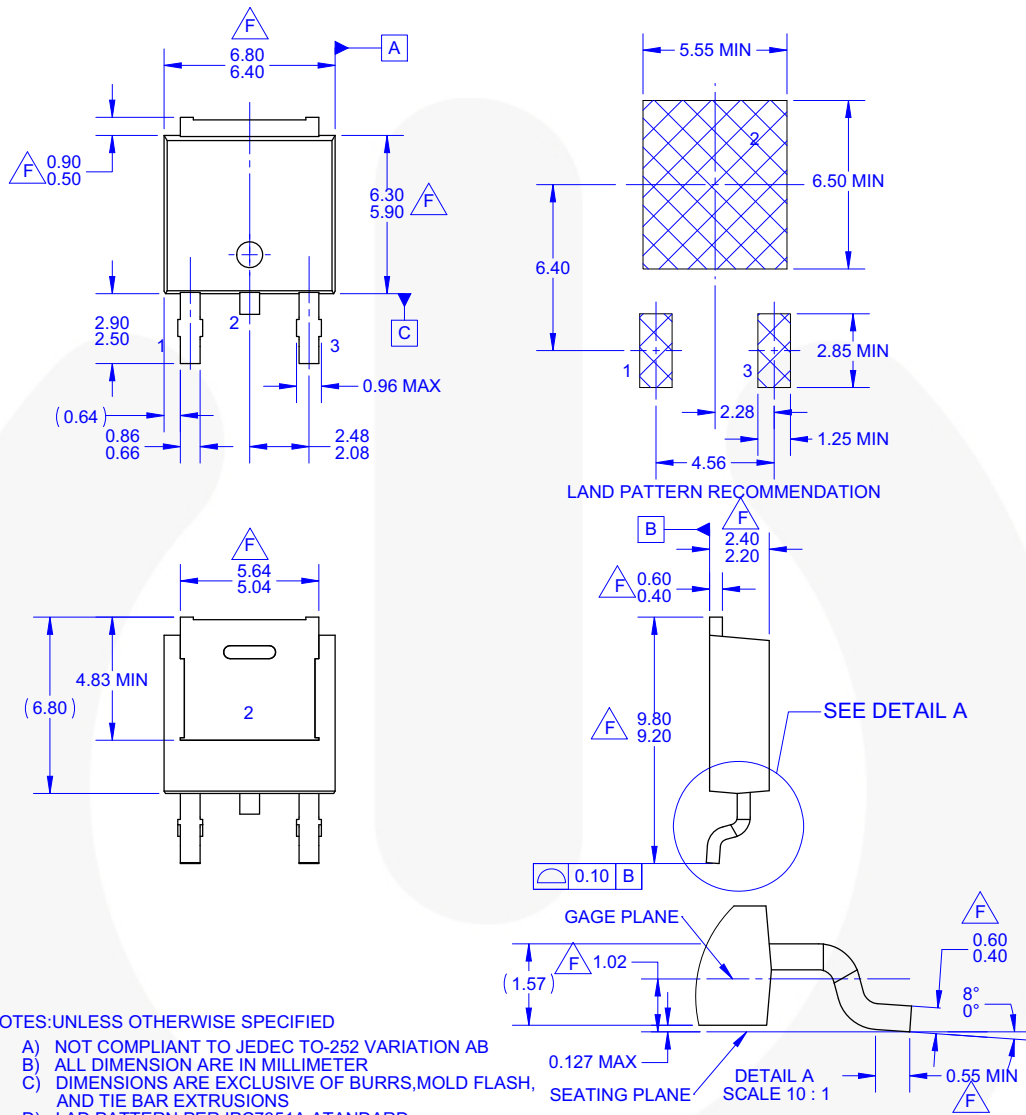

Figure 12. Output Stability vs. Output Capacitor Change

Physical Dimensions



NOTES: UNLESS OTHERWISE SPECIFIED

- A) NOT COMPLIANT TO JEDEC TO-252 VARIATION AB
- B) ALL DIMENSION ARE IN MILLIMETER
- C) DIMENSIONS ARE EXCLUSIVE OF BURRS, MOLD FLASH, AND TIE BAR EXTRUSIONS
- D) LAD PATTERN PER IPC7351A ATANDARD TO228P991X239-3N
- E) DRAWING FILE NAME: MKT-TO252D03REV3.
- F) DOES NOT COMPLY JEDEC STANDARD VALUE.
- G) FAIRCHILD SEMICONDUCTOR.

Figure 13. 3-Lead, TO-252, JEDEC TO-252 VAR. AB, SURFACE MOUNT (DPAK)



**TRADEMARKS**

The following includes registered and unregistered trademarks and service marks, owned by Fairchild Semiconductor and/or its global subsidiaries, and is not intended to be an exhaustive list of all such trademarks.

- |                          |  |                                       |                  |
|--------------------------|--|---------------------------------------|------------------|
| AccuPower™               | F-PFS™   |                                       |                  |
| Awinda®                  | FRFET®   | PowerTrench®                          | TinyBoost®       |
| AX-CAP®*                 | Global Power Resource <sup>SM</sup>            | PowerXS™                              | TinyBuck®        |
| BitSiC™                  | GreenBridge™                                   | Programmable Active Droop™            | TinyCalc™        |
| Build it Now™            | Green FPS™                                     | QFET®                                 | TinyLogic®       |
| CorePLUS™                | Green FPS™ e-Series™                           | QS™                                   | TINYOPTO™        |
| CorePOWER™               | Gmax™  | Quiet Series™                         | TinyPower™       |
| CROSSVOLT™               | GTO™   | RapidConfigure™                       | TinyPWM™         |
| CTL™                     | IntelliMAX™                                    |                                       | TinyWire™        |
| Current Transfer Logic™  | ISOPLANAR™                                     | Saving our world, 1mW/W/kW at a time™ | TranSiC™         |
| DEUXPEED®                | Making Small Speakers Sound Louder and Better™ | SignalWise™                           | TriFault Detect™ |
| Dual Cool™               | MegaBuck™                                      | SmartMax™                             | TRUECURRENT®*    |
| EcoSPARK®                | MICROCOUPLER™                                  | SMART START™                          | µSerDes™         |
| EfficientMax™            | MicroFET™                                      | Solutions for Your Success™           |                  |
| ESBC™                    | MicroPak™                                      | SPM®                                  | UHC®             |
|                          | MicroPak2™                                     | STEALTH™                              | Ultra FRFET™     |
| Fairchild®               | MillerDrive™                                   | SuperFET®                             | UniFET™          |
| Fairchild Semiconductor® | MotionMax™                                     | SuperSOT™-3                           | VCX™             |
| FACT Quiet Series™       | MotionGrid®                                    | SuperSOT™-6                           | VisualMax™       |
| FACT®                    | MTi®   | SuperSOT™-8                           | VoltagePlus™     |
| FAST®                    | MTx®   | SupreMOS®                             | XS™              |
| FastvCore™               | MVN®   | SyncFET™                              | Xsens™           |
| FETBench™                | mWSaver®                                       | Sync-Lock™                            | 仙童™              |
| FPS™                     | OptoHiT™                                       |                                       |                  |

\* Trademarks of System General Corporation, used under license by Fairchild Semiconductor.

**DISCLAIMER**

FAIRCHILD SEMICONDUCTOR RESERVES THE RIGHT TO MAKE CHANGES WITHOUT FURTHER NOTICE TO ANY PRODUCTS HEREIN TO IMPROVE RELIABILITY, FUNCTION, OR DESIGN. TO OBTAIN THE LATEST, MOST UP-TO-DATE DATASHEET AND PRODUCT INFORMATION, VISIT OUR WEBSITE AT [HTTP://WWW.FAIRCHILDSEMI.COM](http://www.fairchildsemi.com). FAIRCHILD DOES NOT ASSUME ANY LIABILITY ARISING OUT OF THE APPLICATION OR USE OF ANY PRODUCT OR CIRCUIT DESCRIBED HEREIN; NEITHER DOES IT CONVEY ANY LICENSE UNDER ITS PATENT RIGHTS, NOR THE RIGHTS OF OTHERS. THESE SPECIFICATIONS DO NOT EXPAND THE TERMS OF FAIRCHILD'S WORLDWIDE TERMS AND CONDITIONS, SPECIFICALLY THE WARRANTY THEREIN, WHICH COVERS THESE PRODUCTS.

**LIFE SUPPORT POLICY**

FAIRCHILD'S PRODUCTS ARE NOT AUTHORIZED FOR USE AS CRITICAL COMPONENTS IN LIFE SUPPORT DEVICES OR SYSTEMS WITHOUT THE EXPRESS WRITTEN APPROVAL OF FAIRCHILD SEMICONDUCTOR CORPORATION.

As used herein:

1. Life support devices or systems are devices or systems which, (a) are intended for surgical implant into the body or (b) support or sustain life, and (c) whose failure to perform when properly used in accordance with instructions for use provided in the labeling, can be reasonably expected to result in a significant injury of the user.
2. A critical component in any component of a life support, device, or system whose failure to perform can be reasonably expected to cause the failure of the life support device or system, or to affect its safety or effectiveness.

**ANTI-COUNTERFEITING POLICY**

Fairchild Semiconductor Corporation's Anti-Counterfeiting Policy. Fairchild's Anti-Counterfeiting Policy is also stated on our external website, [www.fairchildsemi.com](http://www.fairchildsemi.com), under Sales Support.

Counterfeiting of semiconductor parts is a growing problem in the industry. All manufacturers of semiconductor products are experiencing counterfeiting of their parts. Customers who inadvertently purchase counterfeit parts experience many problems such as loss of brand reputation, substandard performance, failed applications, and increased cost of production and manufacturing delays. Fairchild is taking strong measures to protect ourselves and our customers from the proliferation of counterfeit parts. Fairchild strongly encourages customers to purchase Fairchild parts either directly from Fairchild or from Authorized Fairchild Distributors who are listed by country on our web page cited above. Products customers buy either from Fairchild directly or from Authorized Fairchild Distributors are genuine parts, have full traceability, meet Fairchild's quality standards for handling and storage and provide access to Fairchild's full range of up-to-date technical and product information. Fairchild and our Authorized Distributors will stand behind all warranties and will appropriately address any warranty issues that may arise. Fairchild will not provide any warranty coverage or other assistance for parts bought from Unauthorized Sources. Fairchild is committed to combat this global problem and encourage our customers to do their part in stopping this practice by buying direct or from authorized distributors.

**PRODUCT STATUS DEFINITIONS**

**Definition of Terms**

Datasheet Identification	Product Status	Definition
Advance Information	Formative / In Design	Datasheet contains the design specifications for product development. Specifications may change in any manner without notice.
Preliminary	First Production	Datasheet contains preliminary data; supplementary data will be published at a later date. Fairchild Semiconductor reserves the right to make changes at any time without notice to improve design.
No Identification Needed	Full Production	Datasheet contains final specifications. Fairchild Semiconductor reserves the right to make changes at any time without notice to improve the design.
Obsolete	Not In Production	Datasheet contains specifications on a product that is discontinued by Fairchild Semiconductor. The datasheet is for reference information only.