

Parameters	Ratings	Units
Blocking Voltage	600	$V_p$
AC Operating Voltage	260	$V_{rms}$
Load Current <sup>1</sup>	250	$mA_{rms}$
On State Voltage Drop	3	$V_{rms}$ (at $I_L = 250mA_{rms}$ )

<sup>1</sup> One Pole Operating

### Features

- Load Current up to 250  $mA_{rms}$
- 600 $V_p$  Blocking Voltage
- 5mA Sensitivity
- Zero-Crossing Detection
- DC Control, AC Output
- Optically Isolated
- Low EMI and RFI Generation
- High Noise Immunity
- Flammability Rating UL 94 V-0

### Applications

- Programmable Control
- Process Control
- Power Control Panels
- Remote Switching
- Gas Pump Electronics
- Contactors
- Large Relays
- Solenoids
- Motors
- Heaters

### Description

The CPC1961 is a dual single-pole AC solid state relay that uses optical coupling with dual monolithic SCR outputs to produce an alternative to optocoupler and Triac circuits. The CPC1961 switches are robust enough to provide up to a 600 $V_p$  blocking voltage.

In addition, tightly controlled zero cross circuitry ensures switching of AC loads without the generation of transients.

The input and output circuits are optically coupled to provide 3750 $V_{rms}$  of isolation and noise immunity between control and load circuits. As a result the CPC1961 is well suited for industrial environments where electromagnetic interference would disrupt the operation of electromechanical relays.

The CPC1961 is offered in a space saving 8-pin DIP package with two independent switches.

### Approvals

- UL Recognized Component: File 69938
- CSA Certified Component: File 043639

### Ordering Information

Part #	Description
CPC1961G	8-Pin Dip (50/Tube)
CPC1961GS	8-Pin Surface Mount (50/Tube)
CPC1961GSTR	8-Pin Surface Mount (1000/Reel)

### Pin Configuration

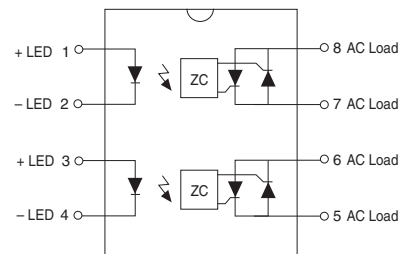

### Absolute Maximum Ratings @ 25°C

Parameter	Ratings	Units
Blocking Voltage	600	V <sub>P</sub>
Reverse Input Voltage	5	V <sub>P</sub>
Input Control Current Peak (10ms)	50	mA
	1	A
Input Power Dissipation <sup>1</sup>	150	mW
Total Package Dissipation <sup>2</sup>	800	mW
Isolation Voltage, Input to Output	3750	V <sub>rms</sub>
Operational Temperature	-40 to +85	°C
Storage Temperature	-40 to +125	°C

<sup>1</sup> Derate linearly 1.33 mW / °C

<sup>2</sup> Derate linearly 6.67 mW / °C

Absolute Maximum Ratings are stress ratings. Stresses in excess of these ratings can cause permanent damage to the device. Functional operation of the device at conditions beyond those indicated in the operational sections of this data sheet is not implied.

Typical values are characteristic of the device at +25°C, and are the result of engineering evaluations. They are provided for information purposes only, and are not part of the manufacturing testing requirements.

### Electrical Characteristics @ 25°C

Parameters	Conditions	Symbol	Min	Typ	Max	Units				
<b>Output Characteristics</b>										
Operating Voltage Range	V <sub>L</sub>	-	20	-	260	V <sub>rms</sub>				
Load Current <sup>1</sup> , Continuous	V <sub>L</sub> =120-240V <sub>rms</sub>	I <sub>L</sub>	0.005	-	250	mA <sub>rms</sub>				
Non-repetitive Single Cycle Surge Current	t ≤ 10ms	I <sub>TSM</sub>	-	-	1	A				
Off State Leakage Current	V <sub>L</sub> =600V	I <sub>LEAK</sub>	-	-	1	μA				
On-State Voltage Drop	I <sub>L</sub> =250 mA <sub>rms</sub>	-	-	-	3	V <sub>rms</sub>				
Critical Rate of Rise <sup>2</sup>	-	dV/dt	500	-	-	V/μs				
Holding Current	I <sub>F</sub> =5 mA	I <sub>H</sub>	-	300	-	μA				
Switching Speeds	I <sub>F</sub> =5 mA	-	-	-	-	cycles				
Turn-on							t <sub>on</sub>	-	-	0.5
Turn-off							t <sub>off</sub>	-	-	0.5
Zero-Cross Turn-On Voltage <sup>3</sup>	1st half-cycle	-	-	5	20	V				
	Subsequent half-cycles	-	-	-	5	V				
Operating Frequency	-	-	20	-	500	Hz				
Load Power Factor for Guaranteed Turn-On <sup>4</sup>	-	PF	0.25	-	-	-				
<b>Input Characteristics</b>										
Input Control Current to Activate <sup>5</sup>	-	I <sub>F</sub>	-	1.2	5	mA				
Input Voltage Drop	I <sub>F</sub> =5mA	V <sub>F</sub>	0.9	1.2	1.5	V				
Input Drop-out Voltage	-	-	0.8	-	-	V				
Reverse Input Current	V <sub>R</sub> =5V	I <sub>R</sub>	-	-	10	μA				
<b>Common Characteristics</b>										
Input to Output Capacitance	V <sub>IO</sub> =0V, f=1MHz	C <sub>IO</sub>	-	3	-	pF				

<sup>1</sup> Maximum continuous load current of a single pole or the sum of the load currents with both poles operating simultaneously.

<sup>2</sup> Tested in accordance with EIA/NARM standard RS-443.

<sup>3</sup> Zero Cross 1st half-cycle @ <100Hz

<sup>4</sup> Snubber circuits may be required at low power factors.

<sup>5</sup> For high noise environment use at least 10mA LED drive current.

**PERFORMANCE DATA\***

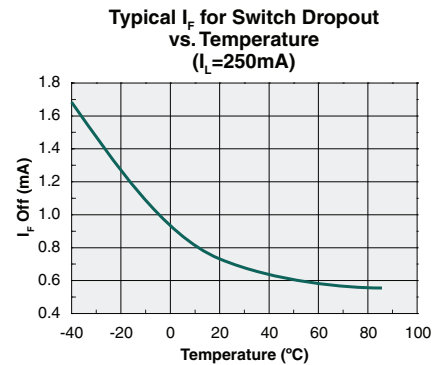
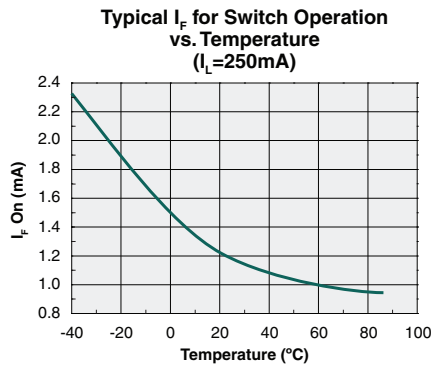
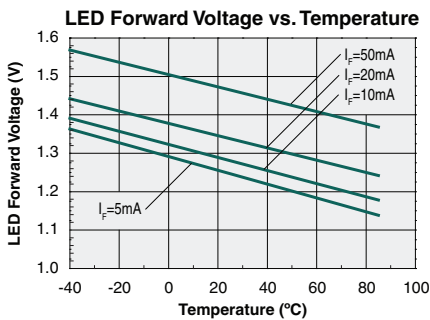
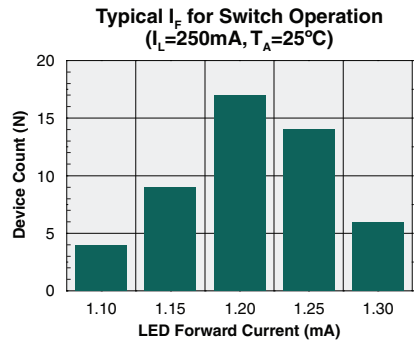
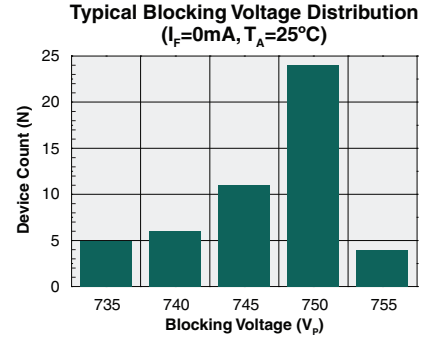
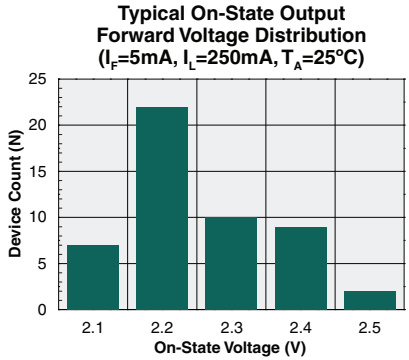
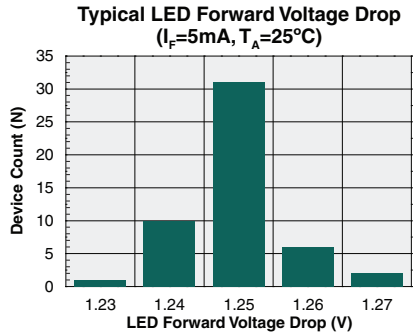

\*Unless otherwise noted, data presented in these graphs is typical of device operation at 25°C.  
For guaranteed parameters not indicated in the written specifications, please contact our application department.

PERFORMANCE DATA\*

Typical On-State Voltage vs. Temperature  
( $I_F=5\text{mA}$ ,  $I_L=250\text{mA}$ )

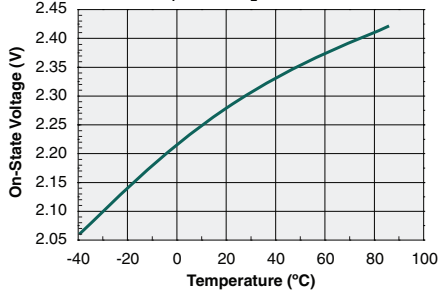

Typical Output Voltage vs. Output Current  
( $I_F=5\text{mA}$ ,  $T_A=25^\circ\text{C}$ )

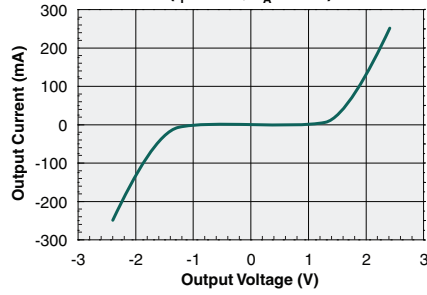

Maximum Concurrent Total Load Current vs. Temperature  
( $I_F=5\text{mA}$ )

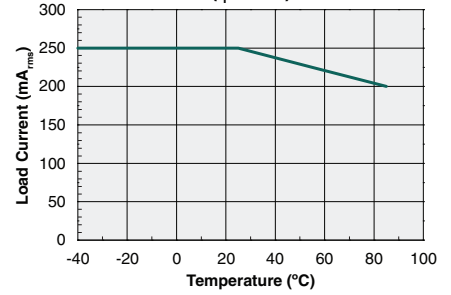

Typical Blocking Voltage vs. Temperature  
( $I_F=0\text{mA}$ )

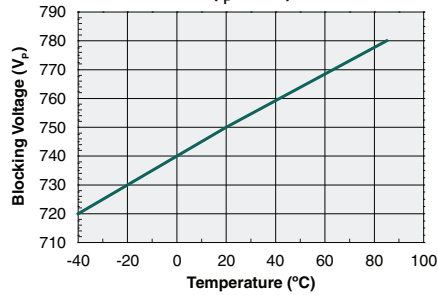

Typical Leakage vs. Temperature Measured Between Pins 5&6 and 7&8  
( $I_F=0\text{mA}$ ,  $V_L=600\text{V}$ )

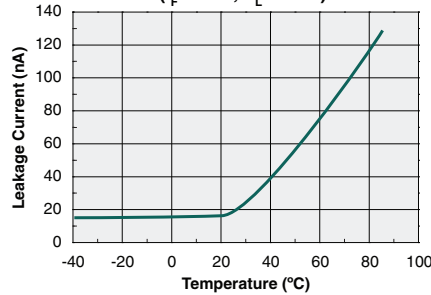

Maximum Non-Repetitive Surge Current  
( $T_A=25^\circ\text{C}$ )

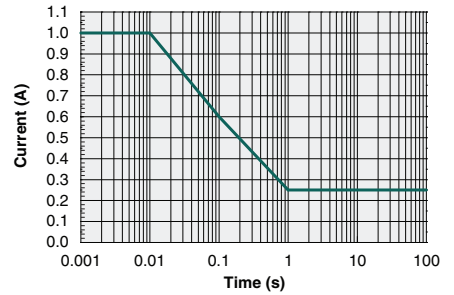

\*Unless otherwise noted, data presented in these graphs is typical of device operation at 25°C.  
For guaranteed parameters not indicated in the written specifications, please contact our application department.

## Manufacturing Information

### Moisture Sensitivity



All plastic encapsulated semiconductor packages are susceptible to moisture ingress. IXYS Integrated Circuits classifies its plastic encapsulated devices for moisture sensitivity according to the latest version of the joint industry standard, **IPC/JEDEC J-STD-020**, in force at the time of product evaluation. We test all of our products to the maximum conditions set forth in the standard, and guarantee proper operation of our devices when handled according to the limitations and information in that standard as well as to any limitations set forth in the information or standards referenced below.

Failure to adhere to the warnings or limitations as established by the listed specifications could result in reduced product performance, reduction of operable life, and/or reduction of overall reliability.

This product carries a Moisture Sensitivity Level (MSL) classification as shown below, and should be handled according to the requirements of the latest version of the joint industry standard **IPC/JEDEC J-STD-033**.

Device	Moisture Sensitivity Level (MSL) Classification
CPC1961G / CPC1961GS	MSL 1

### ESD Sensitivity



This product is **ESD Sensitive**, and should be handled according to the industry standard **JESD-625**.

### Soldering Profile

Provided in the table below is the Classification Temperature ( $T_C$ ) of this product and the maximum dwell time the body temperature of this device may be ( $T_C - 5$ )°C or greater. The classification temperature sets the Maximum Body Temperature allowed for this device during lead-free reflow processes. For through-hole devices, and any other processes, the guidelines of **J-STD-020** must be observed.

Device	Classification Temperature ( $T_C$ )	Dwell Time ( $t_p$ )	Max Reflow Cycles
CPC1961G	250°C	30 seconds	1
CPC1961GS	250°C	30 seconds	3

### Board Wash

IXYS Integrated Circuits recommends the use of no-clean flux formulations. Board washing to reduce or remove flux residue following the solder reflow process is acceptable provided proper precautions are taken to prevent damage to the device. These precautions include, but are not limited to: using a low pressure wash and providing a follow up bake cycle sufficient to remove any moisture trapped within the device due to the washing process. Due to the variability of the wash parameters used to clean the board, determination of the bake temperature and duration necessary to remove the moisture trapped within the package is the responsibility of the user (assembler). Cleaning or drying methods that employ ultrasonic energy may damage the device and should not be used. Additionally, the device must not be exposed to flux or solvents that are Chlorine- or Fluorine-based.



**MECHANICAL DIMENSIONS**

**CPC1961G**

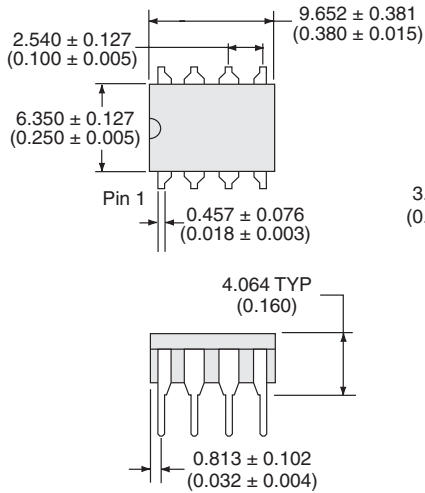

**PCB Hole Pattern**

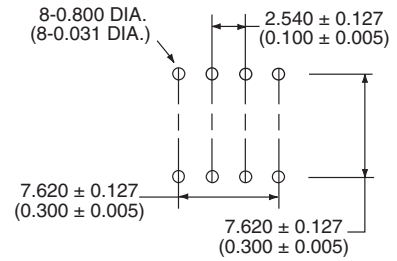

Dimensions  
mm  
(inches)

**CPC1961GS**

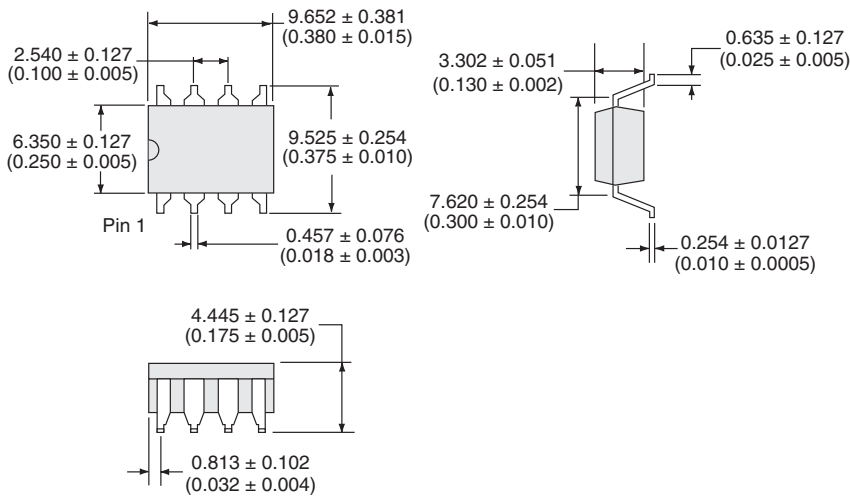

**PCB Land Pattern**

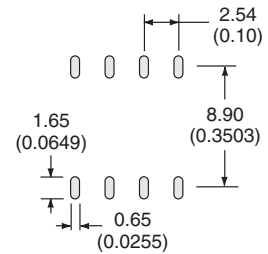

Dimensions  
mm  
(inches)

**CPC1961GSTR Tape & Reel**

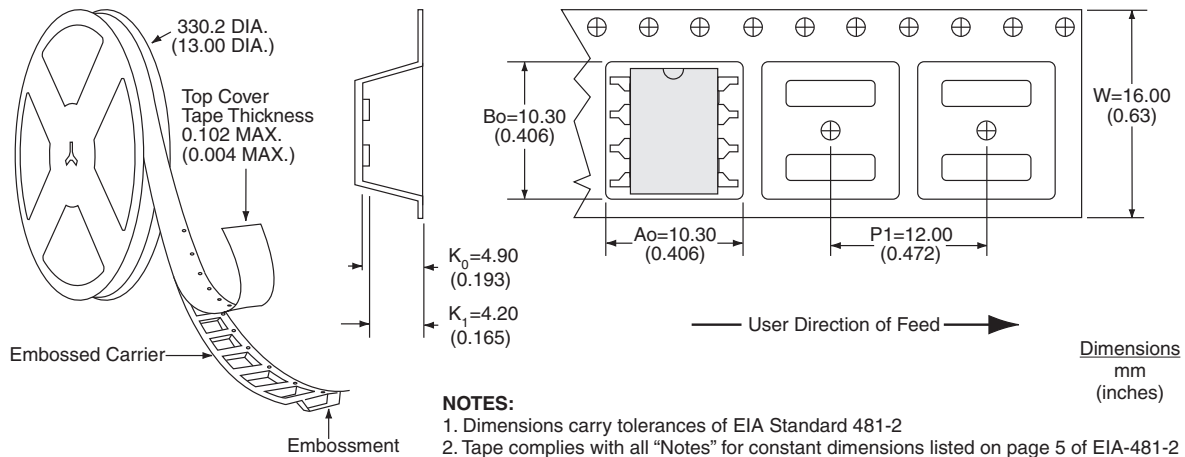

**For additional information please visit our website at: [www.ixysic.com](http://www.ixysic.com)**

IXYS Integrated Circuits makes no representations or warranties with respect to the accuracy or completeness of the contents of this publication and reserves the right to make changes to specifications and product descriptions at any time without notice. Neither circuit patent licenses nor indemnity are expressed or implied. Except as set forth in IXYS Integrated Circuits' Standard Terms and Conditions of Sale, IXYS Integrated Circuits assumes no liability whatsoever, and disclaims any express or implied warranty, relating to its products including, but not limited to, the implied warranty of merchantability, fitness for a particular purpose, or infringement of any intellectual property right.

The products described in this document are not designed, intended, authorized or warranted for use as components in systems intended for surgical implant into the body, or in other applications intended to support or sustain life, or where malfunction of IXYS Integrated Circuits' product may result in direct physical harm, injury, or death to a person or severe property or environmental damage. IXYS Integrated Circuits reserves the right to discontinue or make changes to its products at any time without notice.

The information below supercedes any previously presented material.

For additional information please visit our website at: <https://www.littelfuse.com>



---

Disclaimer Notice - Information furnished is believed to be accurate and reliable. However, users should independently evaluate the suitability of and test each product selected for their own applications. Littelfuse products are not designed for, and may not be used in, all applications. Read complete Disclaimer Notice at [www.littelfuse.com/disclaimer-electronics](http://www.littelfuse.com/disclaimer-electronics).