

Features

- Single-Turn / Cermet / Industrial / Sealed
- Miniature package
- Rotor designed for automatic machine adjust interface
- Withstands harsh environments and immersion cleaning processes
- Tape and reel packaging available

- RoHS compliant* version available
- For trimmer applications/processing guidelines, [click here](#)

3362 - 1/4 " Square Trimpot® Trimming Potentiometer

Electrical Characteristics

| | |
|------------------------------|---------------------------------|
| Standard Resistance Range |20 ohms to 2 megohms |
| | (see standard resistance table) |
| Resistance Tolerance | ±10 % std. |
| Absolute Minimum Resistance | 1 % or 2 ohms |
| | (whichever is greater) |
| Contact Resistance Variation | 1 % or 3 ohms max. |
| | (whichever is greater) |
| Adjustability | |
| Voltage Divider | ±0.05 % |
| Rheostat | ±0.15 % |
| Resolution | Infinite |
| Insulation Resistance | 500 vdc. |
| | 1,000 megohms min. |
| Dielectric Strength | |
| Sea Level | 900 vac |
| 80,000 Feet | 350 vac |
| Adjustment Angle | 240 ° nom. |

Environmental Characteristics

| | |
|-------------------------------|------------------------------------|
| Power Rating (300 volts max.) | |
| 70 °C | 0.50 watt |
| 125 °C | 0 watt |
| Temperature Range | ... -55 °C to +125 °C |
| Temperature Coefficient | ... ±100 ppm/°C |
| Seal Test | 85 °C Fluorinert† |
| Humidity | MIL-STD-202 Method 103 |
| | 96 hours |
| | (2 % ΔTR; 10 Megohms IR) |
| Vibration | 30 G (1 % ΔTR; 1 % ΔVR) |
| Shock | 100 G (1 % ΔTR; 1 % ΔVR) |
| Load Life | 1,000 hours 0.5 watt @ 70 °C |
| | (3 % ΔTR; 3 % or 3 ohms, |
| | whichever is greater, CRV) |
| Rotational Life | 200 cycles |
| | (4 % ΔTR; 3 % or 3 ohms, |
| | whichever is greater, CRV) |

Physical Characteristics

| | |
|--------------------|----------------------------------|
| Mechanical Angle | 270 ° nom. |
| Torque | 3.0 oz-in. max. |
| Stop Strength | 7.0 oz-in. min. |
| Terminals | Solderable pins |
| Weight | 0.02 oz. |
| Marking | Resistance code, |
| | terminal numbers, manufacturer's |
| | model number, style |
| | and date code |
| Wiper | 50 % (Actual TR) ±10 % |
| Flammability | U.L. 94V-0 |
| Standard Packaging | 50 pcs. per tube |
| Adjustment Tool | H-90 |

Product Dimensions

Common Dimensions

Top Adjust

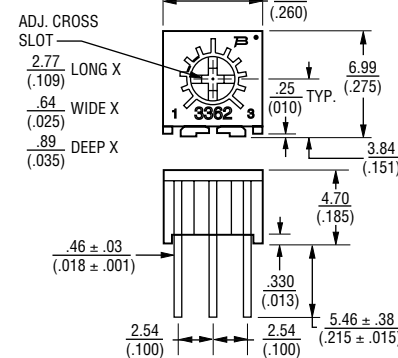

3362F

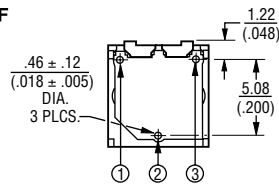

3362H

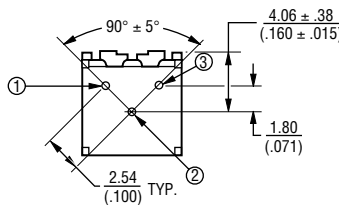

3362P

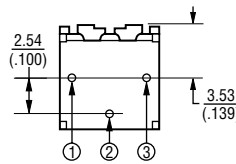

3362R

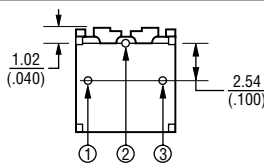

3362U

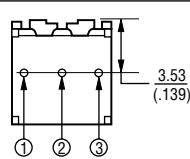

Common Dimensions

Side Adjust

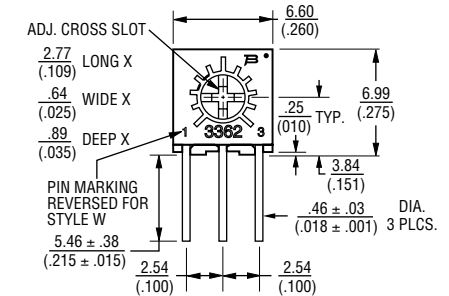

3362M

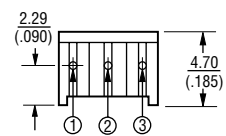

3362S

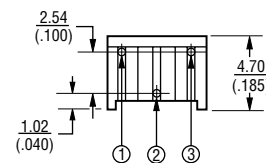

3362W

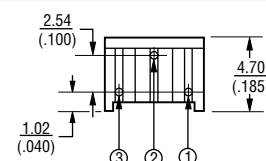

3362X

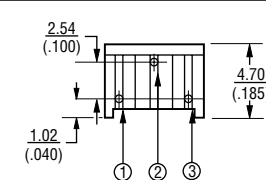

3362Z

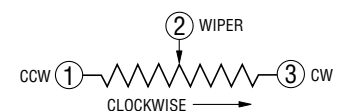
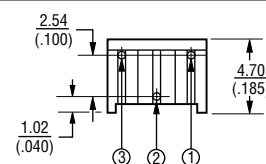

DIMENSIONS: $\frac{\text{MM}}{\text{(INCHES)}}$

TOLERANCES: ± $\frac{0.25}{(.010)}$ EXCEPT WHERE NOTED

*RoHS Directive 2002/95/EC Jan. 27, 2003 including annex and RoHS Recast 2011/65/EU June 8, 2011.

†"Fluorinert" is a registered trademark of 3M Co. Specifications are subject to change without notice.

The device characteristics and parameters in this data sheet can and do vary in different applications and actual device performance may vary over time. Users should verify actual device performance in their specific applications.

3362 - 1/4 " Square Trimpot® Trimming Potentiometer **BOURNS®**

Product Dimensions

Top adjust models 3362F, H, P, R and U are available with a knob for finger adjustment. Add suffix letter "T" to order code.

("P" Style shown)

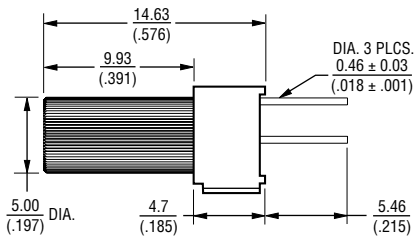
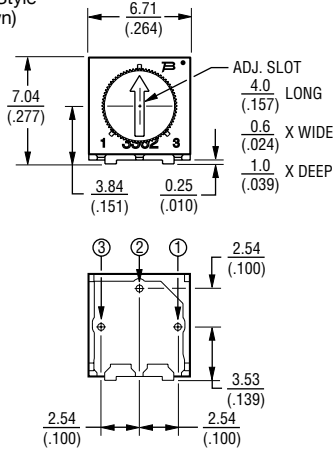

DIMENSIONS: $\frac{\text{MM}}{\text{(INCHES)}}$

TOLERANCES: $\pm \frac{0.25}{(.010)}$ EXCEPT WHERE NOTED

Packaging Specifications

SIDE ADJUST 3362M-1

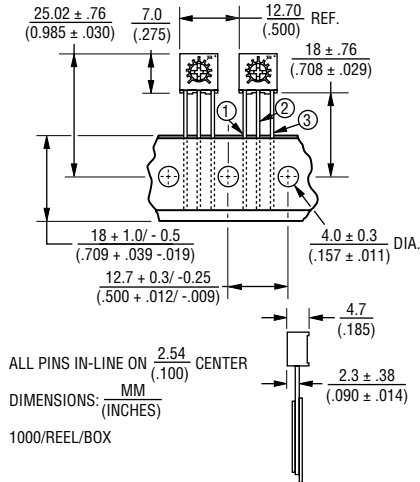

TOP ADJUST 3362U-1, 3362P-1

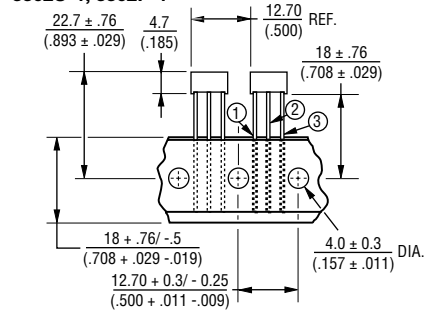

SIDE VIEW 3362U-1

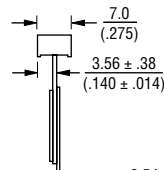

SIDE VIEW 3362P-1



ALL PINS IN-LINE ON $\frac{2.54}{(.100)}$ CENTER

DIMENSIONS: $\frac{\text{MM}}{\text{(INCHES)}}$

Meets EIA Specification 468.

750/REEL
1000/BOX

How To Order

3362 P - 1 - 502 T LF

Model _____
 Style _____
 Standard or Modified _____
 Product Indicator _____
 -1 = Standard Product
 Resistance Code _____
 Optional Suffix Letter _____
 T = Knob*
 Packaging Designator _____
 Blank = Tube (Standard)
 R = Tape and Reel
 (M, U and P Pin Styles Only)
 A = Ammo Pack
 (M, U and P Pin Styles Only)

Terminations _____
 LF = 100 % Tin-plated (RoHS compliant)
 Blank = 90 % Tin / 10 % Lead-plated
 (Standard)

*Knob option is available only in standard Tube packaging for terminal styles F, H, P, R and U.

Consult factory for other available options.

Standard Resistance Table

| Resistance (Ohms) | Resistance Code |
|-------------------|-----------------|
| 20 | 200 |
| 50 | 500 |
| 100 | 101 |
| 200 | 201 |
| 500 | 501 |
| 1,000 | 102 |
| 2,000 | 202 |
| 5,000 | 502 |
| 10,000 | 103 |
| 20,000 | 203 |
| 25,000 | 253 |
| 50,000 | 503 |
| 100,000 | 104 |
| 200,000 | 204 |
| 250,000 | 254 |
| 500,000 | 504 |
| 1,000,000 | 105 |
| 2,000,000 | 205 |

Popular distribution resistance values listed in boldface. Special resistances available.