

Female TERMINAL

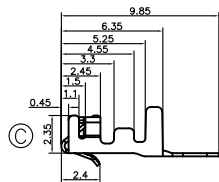

Female Terminal

Wire Range		O.D of Wire
Section Area (mm ²)	AWG#	mm
0.08~0.33	28~22	1.2~1.9

Female Housing

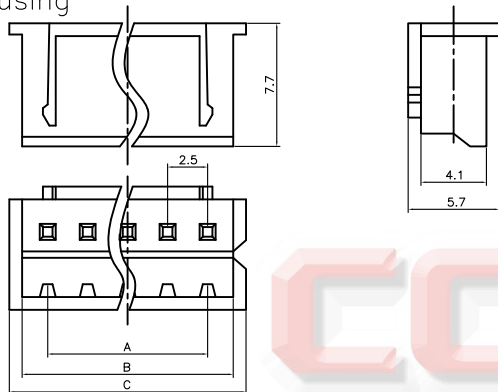

Female HOUSING

Position	DIMENSION		
	A	B	C
2	2.5	5.7	7.3
3	5.0	8.2	9.8
4	7.5	10.7	12.3
5	10.0	13.2	14.8
6	12.5	15.7	17.3
7	15.0	18.2	19.8
8	17.5	20.7	22.3
9	20.0	23.2	24.8
10	22.5	25.7	27.3
11	25.0	28.2	29.8
12	27.5	30.7	32.3
13	30.0	33.2	34.8
14	32.5	35.7	37.3
15	35.0	38.2	39.8
16	37.5	40.7	42.3
17	40.0	43.2	44.8
18	42.5	45.7	47.3
19	45.0	48.2	49.8
20	47.5	50.7	52.3

Male

Position	DIMENSION	
	A	B
2	2.5	7.4
3	5.0	9.9
4	7.5	12.4
5	10.0	14.9
6	12.5	17.4
7	15.0	19.9
8	17.5	22.4
9	20.0	24.9
10	22.5	27.4
11	25.0	29.9
12	27.5	32.4
13	30.0	34.9
14	32.5	37.4
15	35.0	39.9
16	37.5	42.4
17	40.0	44.9
18	42.5	47.4
19	45.0	49.9
20	47.5	52.4

Male V/T TYPE

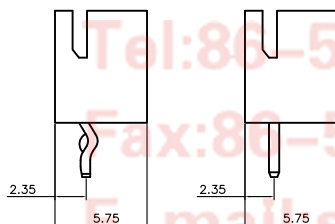
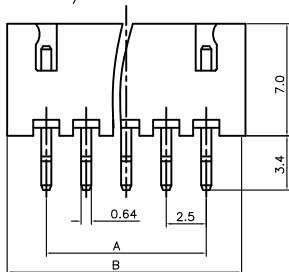

Male Right Angle

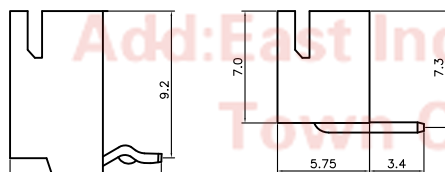
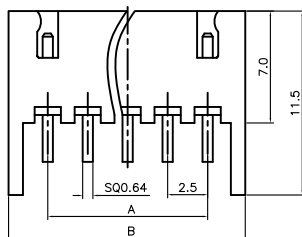

2-7(include) pins

Type A

Type B

GENERAL TOLERANCE		ANGLE TOLERANCE	
.X	±0.60	.X	±5°
.X	±0.38	.X	±3°
.XX	±0.25	.XX	±2°

DRAWING TYPE		CUSTOMER	
SCALE	1:1	SHEET	1 OF 1
DRAWING NO.	C-DS1069-XXXXX-C		

PROJECTION	TITLE
UNITS	P.C.B CONNECTOR 2.5mm XH TYPE
SHEET SIZE	SERIES DS1069 SERIES

NOTES:

1. MAIN SPECIFICATIONS

- . Housing material: NYLON 66
- . Wire range: AWG#28~#22
- . Rated voltage: 250V
- . Rated current: 1A
- . Contact resistance: ≤ 30mΩ
- . Insulation resistance: ≥ 1000MΩ
- . Withstanding voltage: 500V,AC 1 minute
- . Temperature range: -25 ~ +85°C
- . Recommend PC board thickness:1.6mm

2. PRODUCT NUMBER CODE:

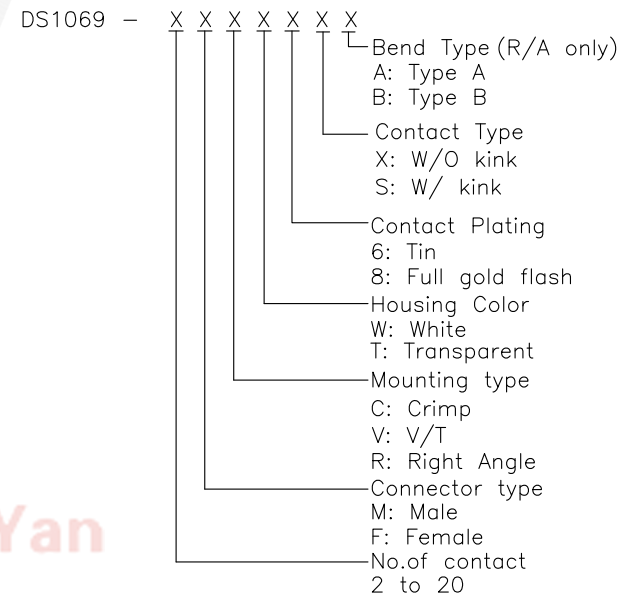

晨翔电子有限公司
CONNFLY CONNFLY ELECTRONIC CO. LTD