

SPECIFICATION

Single Chip Low Cost/Low Power RF Transceiver

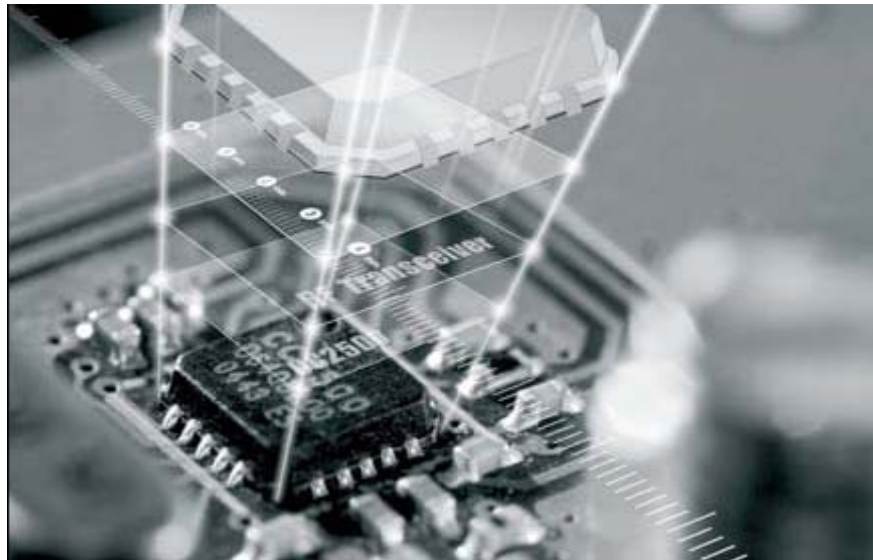

 **Chipcon Products**
from Texas Instruments

Model: 2.4G RF Module
Part no: AU2500-PTI
Version : V1.0

Features

- Small size (QLP 4x4 mm package, 20 pins)
- True single chip 2.4 GHz RF transceiver
- Frequency range: 2400-2483.5 MHz
- High sensitivity (–101 dBm at 10 kbps, 1% packet error rate)
- Programmable data rate up to 500 kbps
- Low current consumption (13.3 mA in RX, 250 kbps, input 30 dB above sensitivity limit)
- Programmable output power up to 0 dBm
- Excellent receiver selectivity and blocking Performance
- Suited for systems compliant with EN 300 328 and EN 300 440 class 2 (Europe), FCC CFR47 Part 15 (US), and ARIB STDT66 (Japan)
- Wake-on-radio functionality for automatic low-power RX polling
- Many powerful digital features allow a high-performance RF system to be made using an inexpensive microcontroller
- Integrated analog temperature sensor
- Lead-free “green” package
- Flexible support for packet oriented systems: On chip support for sync word detection, address check, flexible packet length and automatic CRC handling.
- Programmable channel filter bandwidth
- FSK, GFSK and MSK supported
- OOK supported
- Very few external components: Completely on-chip frequency synthesizer, no external filters or RF switch needed
- Programmable baseband modem
- Ideal for multi-channel operation
- Configurable packet handling hardware
- Suitable for frequency hopping systems due to a fast settling frequency synthesizer
- Optional Forward Error Correction with interleaving
- Separate 64-byte RX and TX data FIFOs
- Efficient SPI interface: All registers can be programmed with one “burst” transfer
- Digital RSSI output
- Automatic Frequency Compensation (AFC) can be used to align the frequency synthesizer to received centre frequency
- Optional automatic whitening and dewatering of data
- Support for asynchronous transparent receive/transmit mode for backwards compatibility with existing radio communication protocols
- Programmable Carrier Sense indicator
- Programmable Preamble Quality Indicator (PQI) for detecting preambles and improved protection against sync word detection in random noise
- Support for automatic Clear Channel Assessment (CCA) before transmitting (for listen-before-talk systems)
- Support for per-package Link Quality Indication

- **Document Title**

Denomination : 2.4G RF Module

Part No. : AU2500-PTI



- **Revision History**

Revision No.	History	Auther	Date
V1.0	ISSUE		2010/ 3/ 19

Application

- 2400-2483.5 MHz ISM/SRD band systems
- Consumer Electronics
- Wireless game controllers
- Wireless audio
- Wireless keyboard and mouse

Specification

1. True single Module 2.4GHz RF transceiver.
2. Frequency range: 2400-2483.3MHz.
3. Programmable baseband module.
4. For multi-channel operation.

Absolute Maximum Ratings



Caution! ESD sensitive device. Precaution should be used when handling the device in order to prevent permanent damage.

Parameter	Min	Max	Units	Condition
Supply voltage	-0.3	3.6	V	All supply pins must have the same voltage
Voltage on any digital pin	-0.3	VDD+0.3, max 3.6	V	
Voltage on the pins RF_P, RF_N and DCOUPL	-0.3	2.0	V	
Voltage ramp-up rate		120	kV/ μ s	
Input RF level		+10	dBm	
Storage temperature range	-50	150	$^{\circ}$ C	
Solder reflow temperature		260	$^{\circ}$ C	According to IPC/JEDEC J-STD-020C
ESD		<500	V	According to JEDEC STD 22, method A114, Human Body Model

Operating Conditions

Parameter	Min	Max	Unit	Condition
Operating temperature	-20	70	$^{\circ}$ C	
Operating supply voltage	1.8	3.6	V	All supply pins must have the same voltage

General Characteristics

Parameter	Min	Typ	Max	Unit	Condition/Note
Frequency range	2400		2483.5	MHz	
Data rate	1.2		500	kbps	FSK
	1.2		250	kbps	GFSK and OOK
	26		500	kbps	(Shaped) MSK (also known as differential offset QPSK)
					Optional Manchester encoding (halves the data rate).

Electrical Specifications

• Current Consumption

T_c = 25°C, VDD = 3.0 V if nothing else stated. All measurement results obtained using the CC2500EM reference design.

Parameter	Min	Typ	Max	Unit	Condition
Current consumption in power down modes		400		nA	Voltage regulator to digital part off, register values retained (SLEEP state)
		900		nA	Voltage regulator to digital part off, register values retained, low-power RC oscillator running (SLEEP state with WOR enabled)
		92		μA	Voltage regulator to digital part off, register values retained, XOSC running (SLEEP state with M0CSM0.OSC_FORCE_ON set)
		160		μA	Voltage regulator to digital part on, all other modules in power down (XOFF state)
Current consumption		8.1		μA	Automatic RX polling once each second, using low-power RC oscillator, with 460 kHz filter bandwidth and 250 kbps data rate, PLL calibration every 4 th wakeup. Average current with signal in channel <i>below</i> carrier sense level.
		35		μA	Same as above, but with signal in channel <i>above</i> carrier sense level, 1.9 ms RX timeout, and no preamble/sync word found.
		1.4		μA	Automatic RX polling every 15 th second, using low-power RC oscillator, with 460 kHz filter bandwidth and 250 kbps data rate, PLL calibration every 4 th wakeup. Average current with signal in channel below carrier sense level.
		42		μA	Same as above, but with signal in channel <i>above</i> carrier sense level, 37 ms RX timeout, and no preamble/sync word found.
		1.5		mA	Only voltage regulator to digital part and crystal oscillator running (IDLE state)
		7.4		mA	Only the frequency synthesizer running (after going from IDLE until reaching RX or TX states, and frequency calibration states)
Current consumption, RX states		15.3		mA	Receive mode, 2.4 kbps, input at sensitivity limit, MDMCFG2.DEM_DCFILT_OFF = 1
		12.8		mA	Receive mode, 2.4 kbps, input 30 dB above sensitivity limit, MDMCFG2.DEM_DCFILT_OFF = 1
		15.4		mA	Receive mode, 10 kbps, input at sensitivity limit, MDMCFG2.DEM_DCFILT_OFF = 1
		12.9		mA	Receive mode, 10 kbps, input 30 dB above sensitivity limit, MDMCFG2.DEM_DCFILT_OFF = 1
		18.8		mA	Receive mode, 250 kbps, input at sensitivity limit, MDMCFG2.DEM_DCFILT_OFF = 0
		15.7		mA	Receive mode, 250 kbps, input 30 dB above sensitivity limit, MDMCFG2.DEM_DCFILT_OFF = 0
		16.6		mA	Receive mode, 250 kbps current optimized, input at sensitivity limit, MDMCFG2.DEM_DCFILT_OFF = 1
		13.3		mA	Receive mode, 250 kbps current optimized, input 30 dB above sensitivity limit, MDMCFG2.DEM_DCFILT_OFF = 1
		19.6		mA	Receive mode, 500 kbps, input at sensitivity limit, MDMCFG2.DEM_DCFILT_OFF = 0
		17.0		mA	Receive mode, 500 kbps, input 30 dB above sensitivity limit, MDMCFG2.DEM_DCFILT_OFF = 0

Current consumption, TX states	11.1		mA	Transmit mode, -12 dBm output power
	15.1		mA	Transmit mode, -6 dBm output power
	21.2		mA	Transmit mode, 0 dBm output power

Crtstal Oscillator

Tc = 25°C, VDD = 3.0 V if nothing else stated.

Parameter	Min	Typ	Max	Unit	Condition/Note
Crystal frequency	26	26	27	MHz	
Tolerance		±40		ppm	This is the total tolerance including a) initial tolerance, b) crystal loading, c) aging and d) temperature dependence. The acceptable crystal tolerance depends on RF frequency and channel spacing / bandwidth.
ESR			100	Ω	
Start-up time		300		μs	Measured on CC2500EM reference design.

Diagram

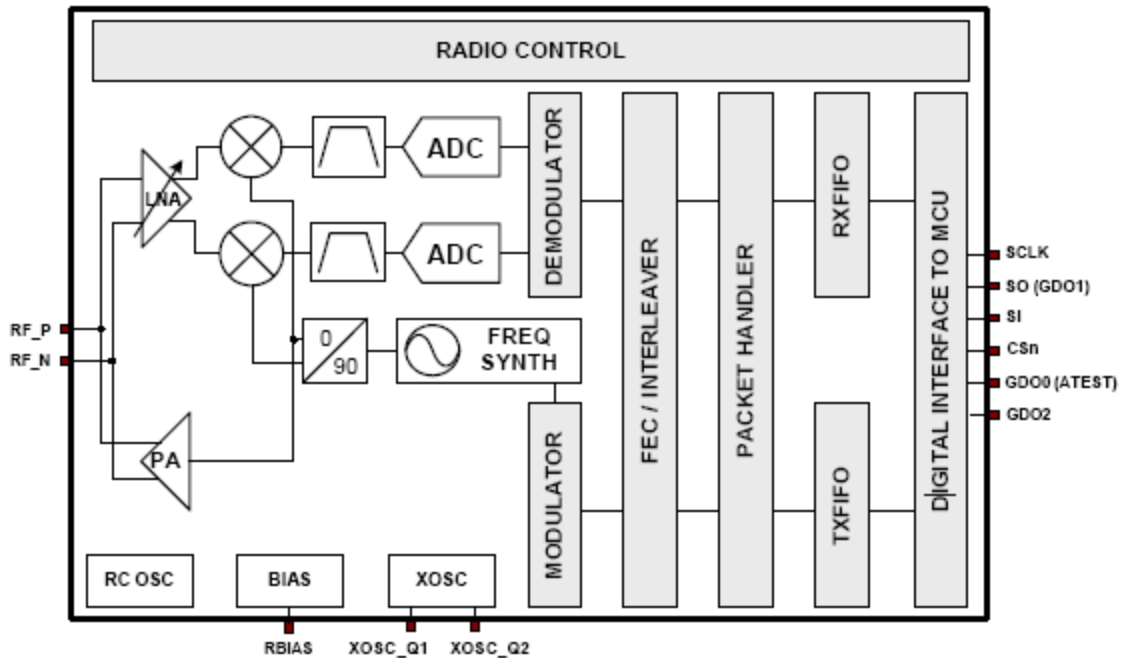

AU2500-PTI RF Module Pin Configuration

- 1.VCC
- 2.MOSI
- 3.SCLK
- 4.MISO
- 5.GDO2
- 6.GND
- 7.GDO0
- 8.Csn

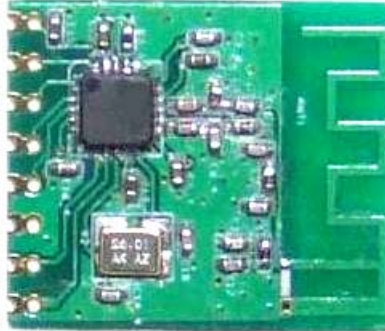

PAD NO	NAME	I / O	DESCRIPTION
1	VCC	P	Power supply 3.3V
2	MOSI	I	Serial configuration interface, data input
3	SCLK	I	Serial configuration interface, clock input
4	MISO	O	Serial configuration interface, data output. Optional general output pin when CSn is high
5	GDO2	O	Digital output pin for general use: <ul style="list-style-type: none"> • Test signals • FIFO status signals • Clear Channel Indicator • Clock output, down-divided from XOSC • Serial output RX data
6	GND	P	Ground
7	GDO0	I/O	Digital output pin for general use: <ul style="list-style-type: none"> • Test signals • FIFO status signals • Clear Channel Indicator • Clock output, down-divided from XOSC • Serial output RX data • Serial input TX data <p>Also used as analog test I/O for prototype/production Testing</p>
8	CSn	I	Serial configuration interface, chip select

AU2500-PTI RF Characteristic

● TX Power / AU2500-PTI

Pattten	Crystal	TX (dbm)		
		2403	2441	2480
1	25.999632	-0.65	-0.68	-0/ 78

● RX Sensitivity / AU2500-PTI

Pattten	RX (sensitivity)								
	2403			2441			2480		
	2.4kbps	250kbps	500kbps	2.4kbps	250kbps	500kbps	2.4kbps	250kbps	500kbps
1	-103	-90	-85	-102	-90	-85	-102	-90	-85

● Harmonic / AU2500-PTI

BALUN Pattern	Harmonic (dBm)								
	2.403GHz (L)			2.441GHz (M)			2.480GHz (H)		
	4.806G Hz	7.209G Hz	9.612G Hz	4.882G Hz	7.323G Hz	9.764G Hz	4.960G Hz	7.440G Hz	9.920G Hz
1	-59.78	-58.61	-58.96	-59.92	-58.52	-59.06	-59.51	-59.49	-58.85

● BALUN / AU2500-PTI

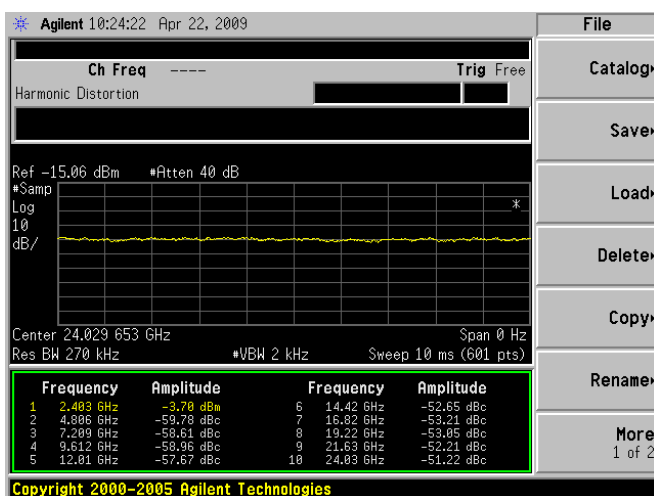

/ Frequency 2.403 GHz

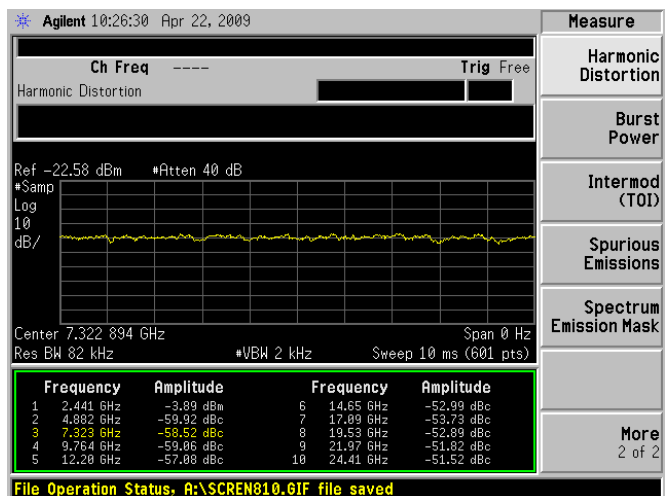

/ Frequency 2.441 GHz

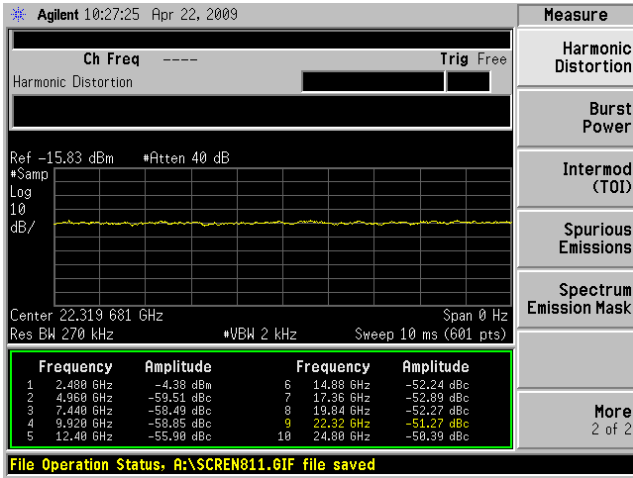

/ Frequency 2.480 GHz

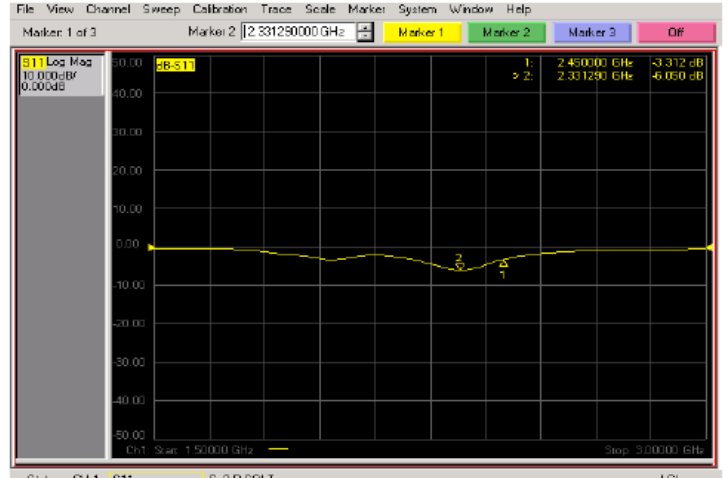

/ S11dB (Die Model)

● AU2500-PTI RF Module Description

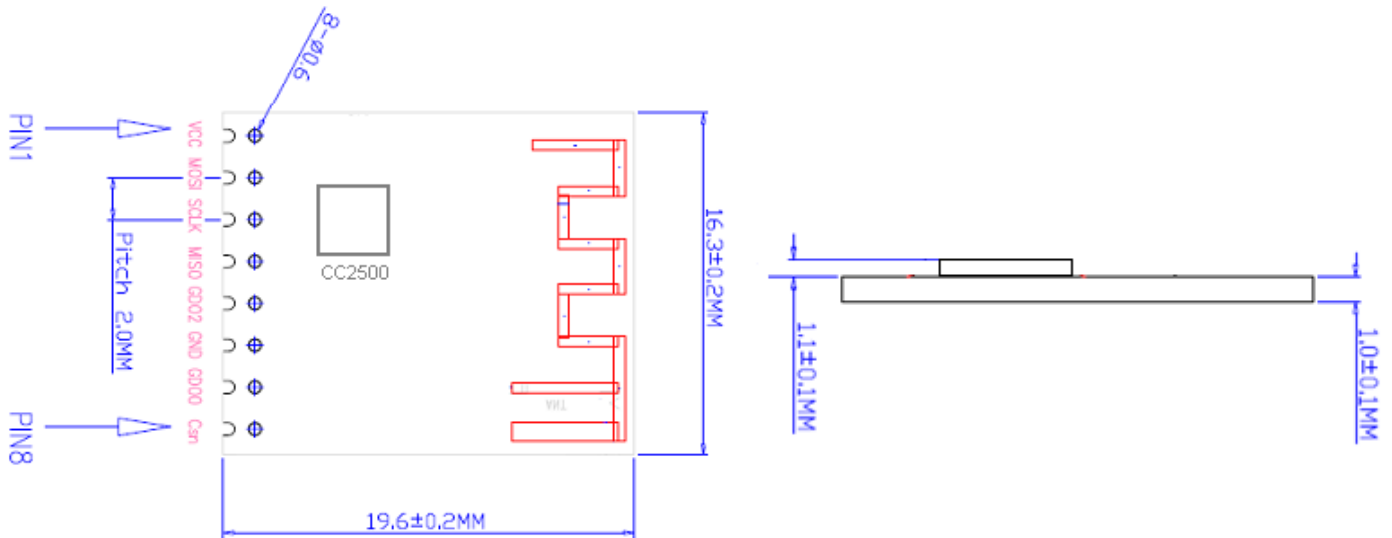

<p>7F., No.25, Siyuan Rd., Xinzhuang City, Taipei County 242, Taiwan (R.O.C.)</p>	<p>TEL:+866-2-2992-1360 FAX:+866-2-2992-2479</p>
---	--