

## Base strip - MSTBA 2,5/12-G-5,08 - 1757349

Please be informed that the data shown in this PDF Document is generated from our Online Catalog. Please find the complete data in the user's documentation. Our General Terms of Use for Downloads are valid (<http://phoenixcontact.com/download>)

Header, Nominal current: 12 A, Rated voltage (III/2): 320 V, Number of positions: 12, Pitch: 5.08 mm, Color: green, Contact surface: Tin, Mounting: Soldering



The figure shows a 10-position version of the product

### Product Features

- Other pin lengths available on request
- Plug-in direction parallel to the conductor axis
- W type with stand-off
- Standard pin strip for 320 V (III/2)



### Key commercial data

Packing unit	1 pc
GTIN	 4 017918 029876
Weight per Piece (excluding packing)	4.8 GRM
Custom tariff number	85366990
Country of origin	Germany

### Technical data

#### Dimensions

Length	12 mm
Pitch	5.08 mm
Dimension a	55.88 mm
Pin dimensions	1 x 1 mm
Hole diameter	1.4 mm

#### General

## Base strip - MSTBA 2,5/12-G-5,08 - 1757349

### Technical data

#### General

Range of articles	MSTBA 2,5/...-G
Insulating material group	I
Rated surge voltage (III/3)	4 kV
Rated surge voltage (III/2)	4 kV
Rated surge voltage (II/2)	4 kV
Rated voltage (III/3)	250 V
Rated voltage (III/2)	320 V
Rated voltage (II/2)	400 V
Connection in acc. with standard	EN-VDE
Nominal current $I_N$	12 A
Maximum load current	12 A
Insulating material	PA
Inflammability class according to UL 94	V0
Color	green
Number of positions	12

### Classifications

#### eCl@ss

eCl@ss 4.0	272607xx
eCl@ss 4.1	27260701
eCl@ss 5.0	27260701
eCl@ss 5.1	27260701
eCl@ss 6.0	27260704
eCl@ss 7.0	27440402
eCl@ss 8.0	27440402

#### ETIM

ETIM 3.0	EC001121
ETIM 4.0	EC002637
ETIM 5.0	EC002637

#### UNSPSC

UNSPSC 6.01	30211810
UNSPSC 7.0901	39121409
UNSPSC 11	39121409
UNSPSC 12.01	39121409
UNSPSC 13.2	39121409

# Base strip - MSTBA 2,5/12-G-5,08 - 1757349

## Approvals

### Approvals

---

#### Approvals

CSA / UL Recognized / VDE Gutachten mit Fertigungsüberwachung / cUL Recognized / IEC60364 CB Scheme / CCA / EAC / cULus Recognized

---

#### Ex Approvals

---

#### Approvals submitted

---

## Approval details

CSA 		
	B	D
Nominal current I <sub>N</sub>	15 A	10 A
Nominal voltage U <sub>N</sub>	300 V	300 V

UL Recognized 		
	B	D
Nominal current I <sub>N</sub>	15 A	10 A
Nominal voltage U <sub>N</sub>	300 V	300 V

VDE Gutachten mit Fertigungsüberwachung 	
Nominal current I <sub>N</sub>	12 A
Nominal voltage U <sub>N</sub>	250 V

# Base strip - MSTBA 2,5/12-G-5,08 - 1757349

## Approvals

cUL Recognized		
	B	D
Nominal current $I_N$	15 A	10 A
Nominal voltage $U_N$	300 V	300 V

IECEE CB Scheme	
Nominal current $I_N$	12 A
Nominal voltage $U_N$	250 V

CCA	
Nominal current $I_N$	12 A
Nominal voltage $U_N$	250 V

EAC
-----

cULus Recognized
------------------

## Drawings

### Diagram

Drilling diagram

Typ:  
IC  
2,5/..-  
G-5,08  
mit  
MSTBA  
2,5/..-  
G-5,08

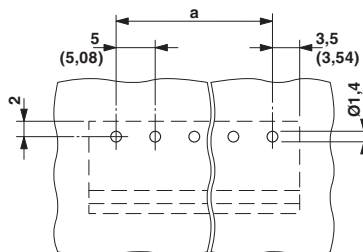

# Base strip - MSTBA 2,5/12-G-5,08 - 1757349

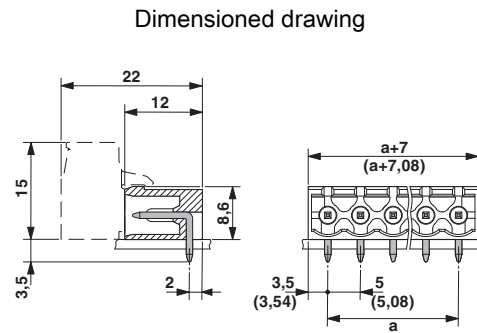
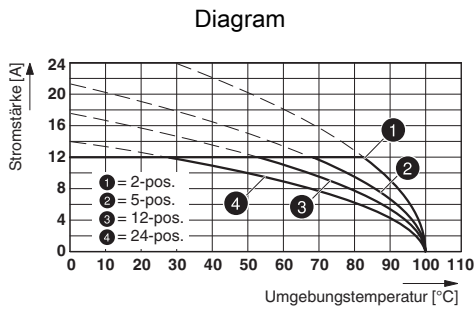

Type: ICV 2,5/..-G-5,08 with MSTBA 2,5/..-G-5,08

Diagram

Plug: QC 1/5-ST(F)-5,08  
Header: MSTB(A) 2,5/5-G(F)-5,08

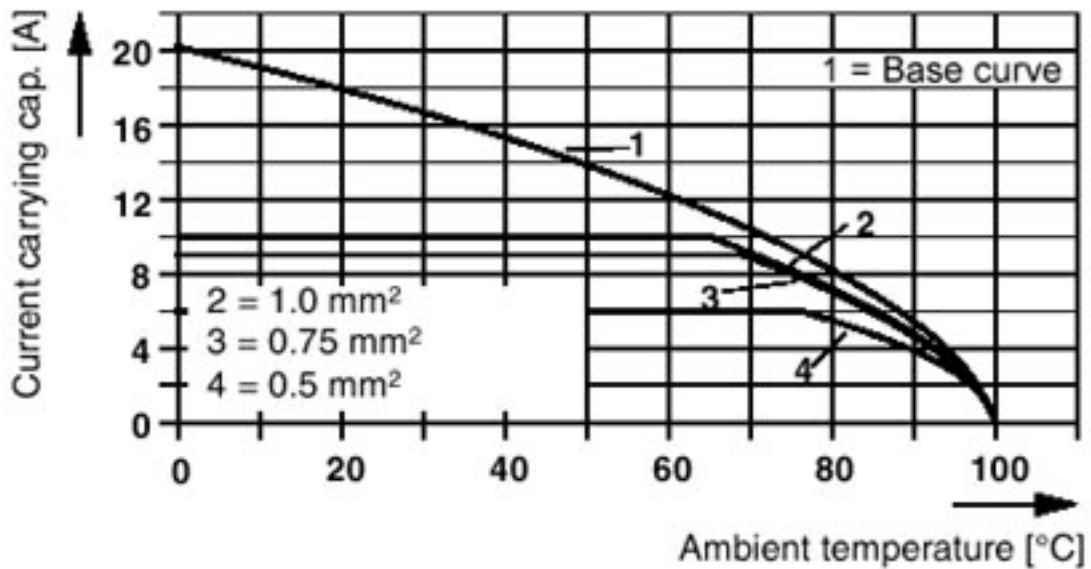

# Base strip - MSTBA 2,5/12-G-5,08 - 1757349

Diagram

Plug: MSTBT 2,5/5-ST(F)-(-5,08)  
Header: MSTB(A) 2,5/5-G(F)-(-5,08)

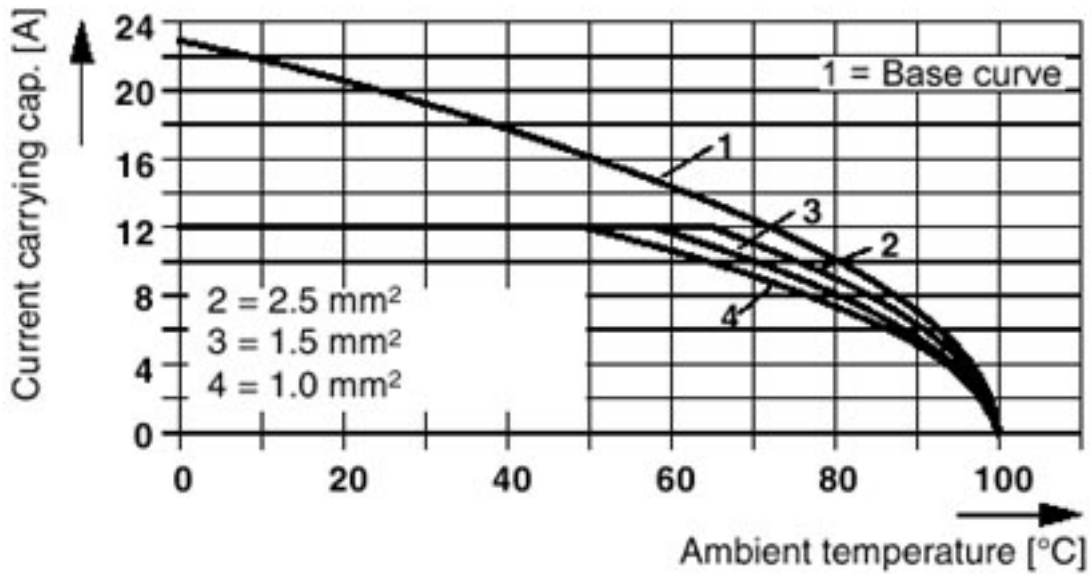

Diagram

Plug: SMSTB 2,5/5-ST(F)-(-5,08)  
Header: MSTB(A) 2,5/5-G(F)-(-5,08)

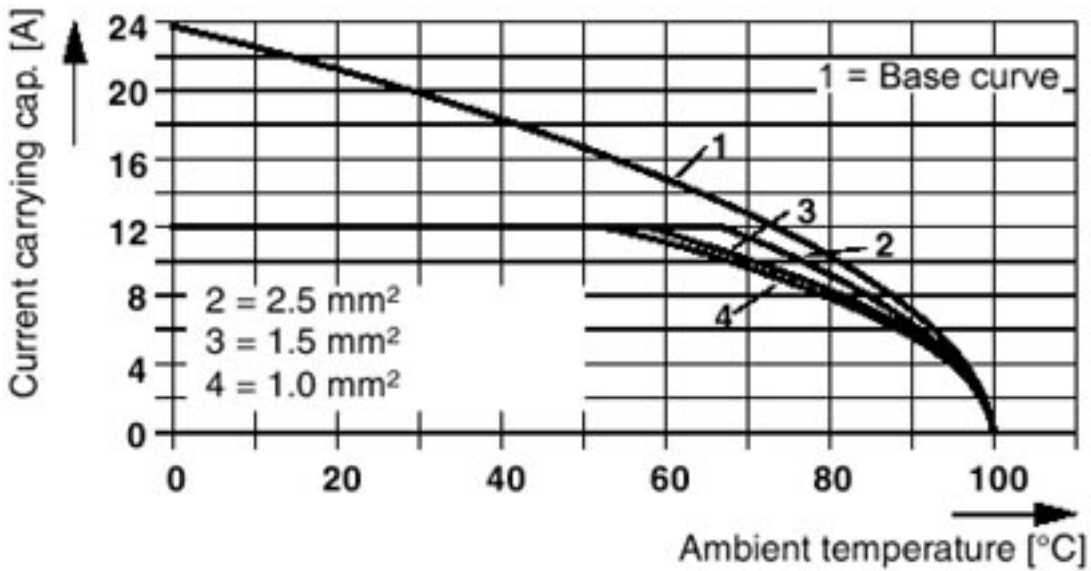

# Base strip - MSTBA 2,5/12-G-5,08 - 1757349

Diagram

Plug: MVSTBR(W) 2,5/5-ST(F)-(-5,08)  
Header: MSTB(A) 2,5/5-G(F)-(-5,08)

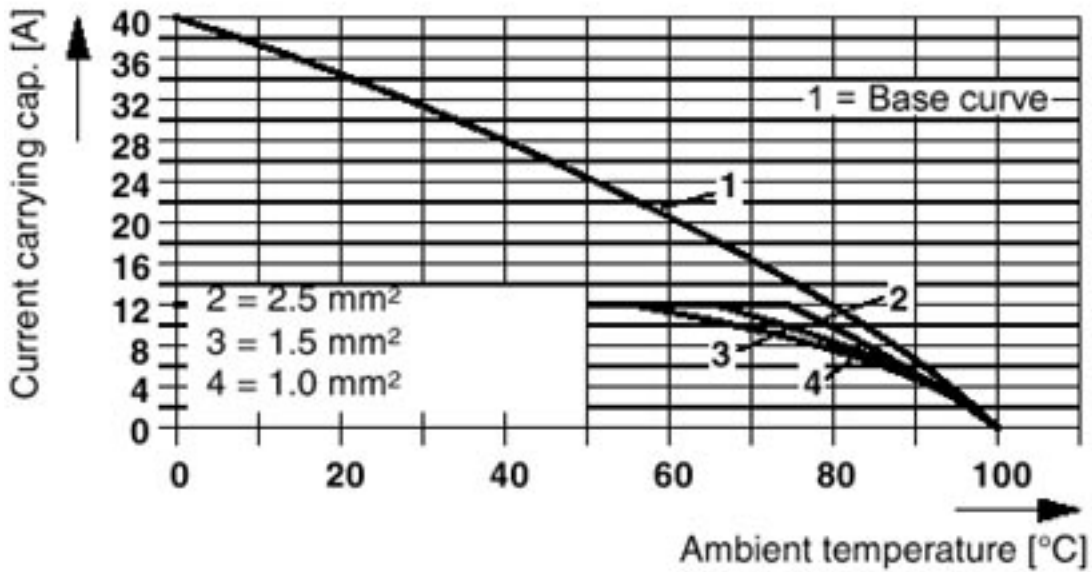

Diagram

Plug: FRONT-MSTB 2,5/5-ST(F)-(-5,08)  
Header: MSTB(A) 2,5/5-G(F)-(-5,08)

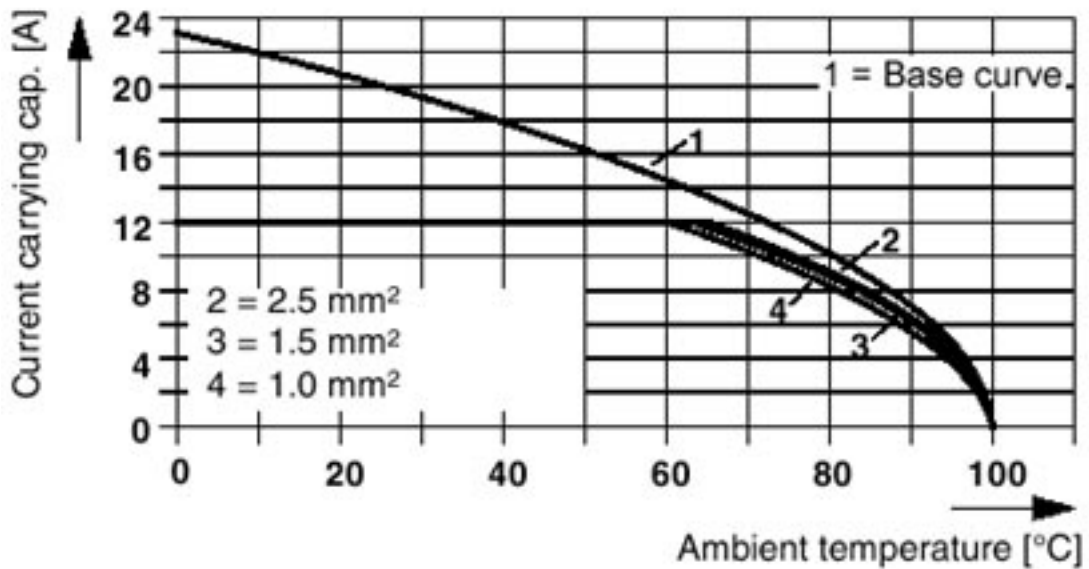

# Base strip - MSTBA 2,5/12-G-5,08 - 1757349

Diagram

Plug: TMSTBP 2,5/5-ST(F)-(-5,08)  
Header: MSTB(A) 2,5/5-G(F)-(-5,08)

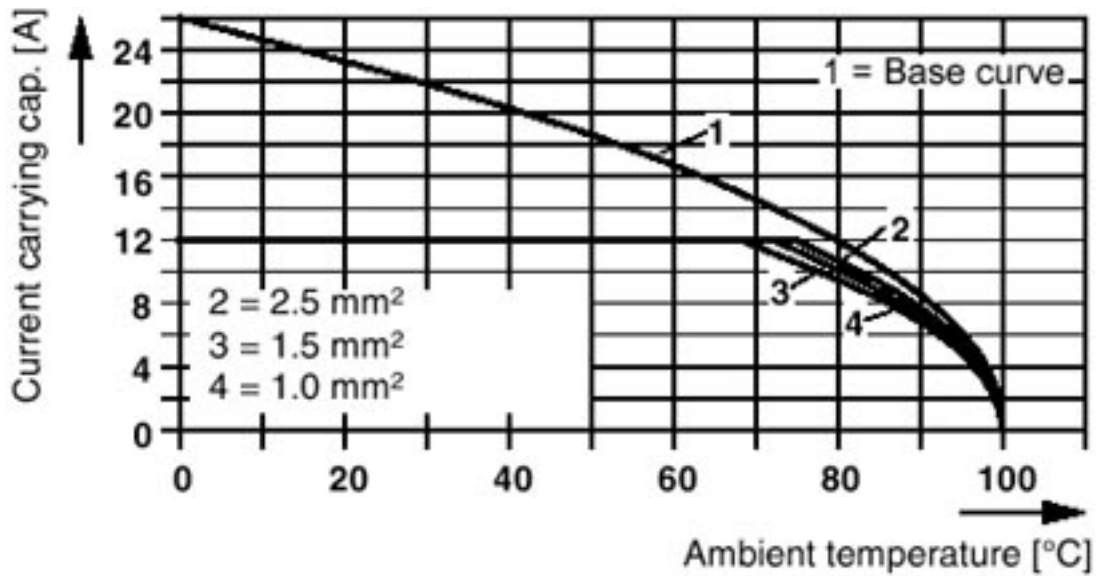

Diagram

Plug: FKC 2,5/5-ST(F)-5,08  
Header: MSTB(A) 2,5/5-G(F)-5,08

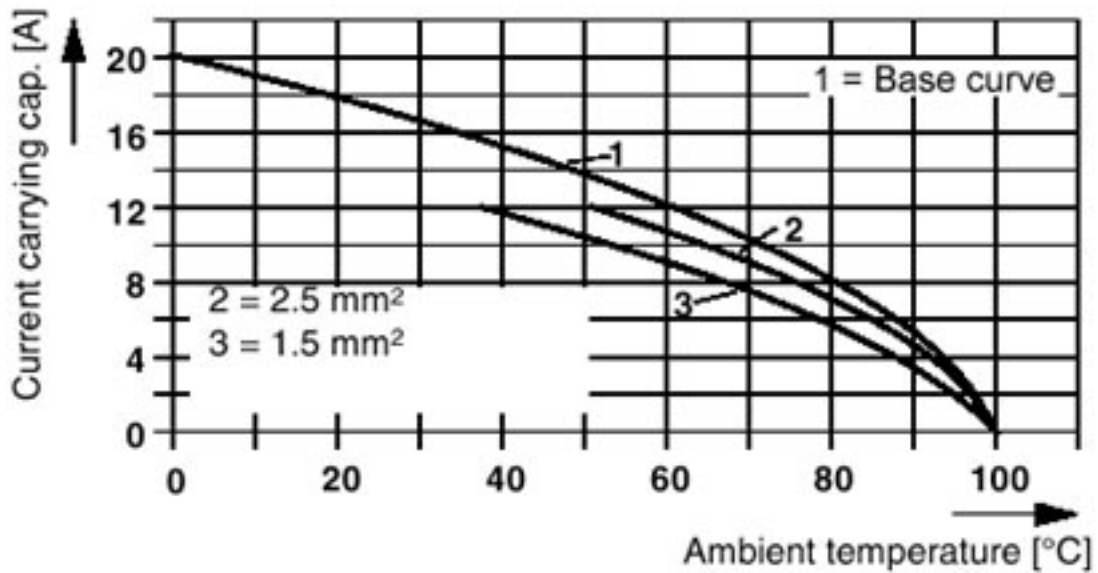



# Base strip - MSTBA 2,5/12-G-5,08 - 1757349

Diagram

Plug: FKCVR(W) 2,5/5-ST(F)-5,08  
Header: MSTB(A) 2,5/5-G(F)-5,08

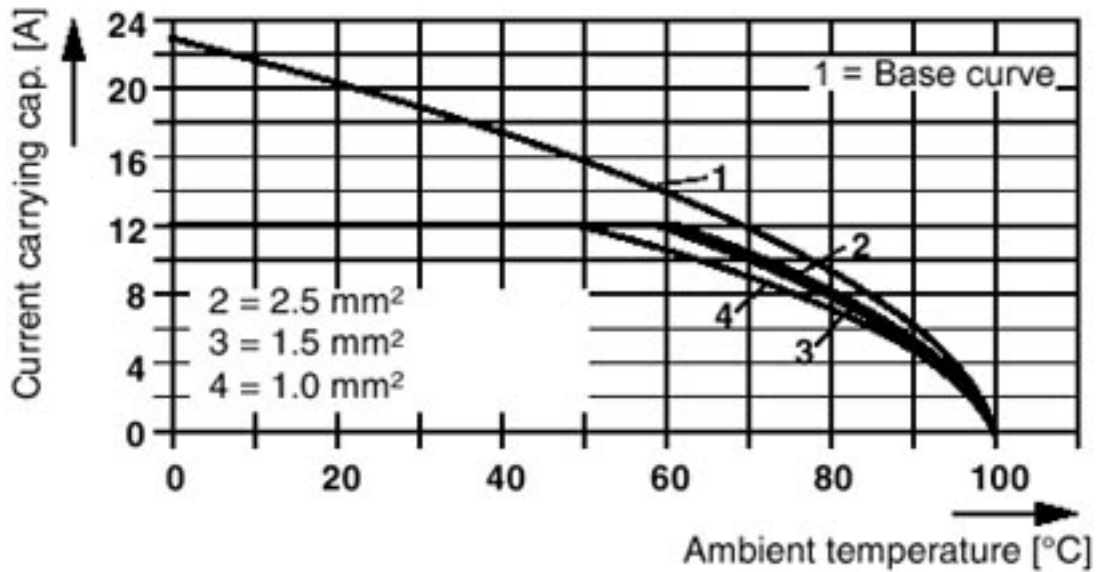

Diagram

Plug: MSTB 2,5/5-ST(F)(-5,08)  
Header: MSTBO 2,5/5-GR(L)(-5,08)

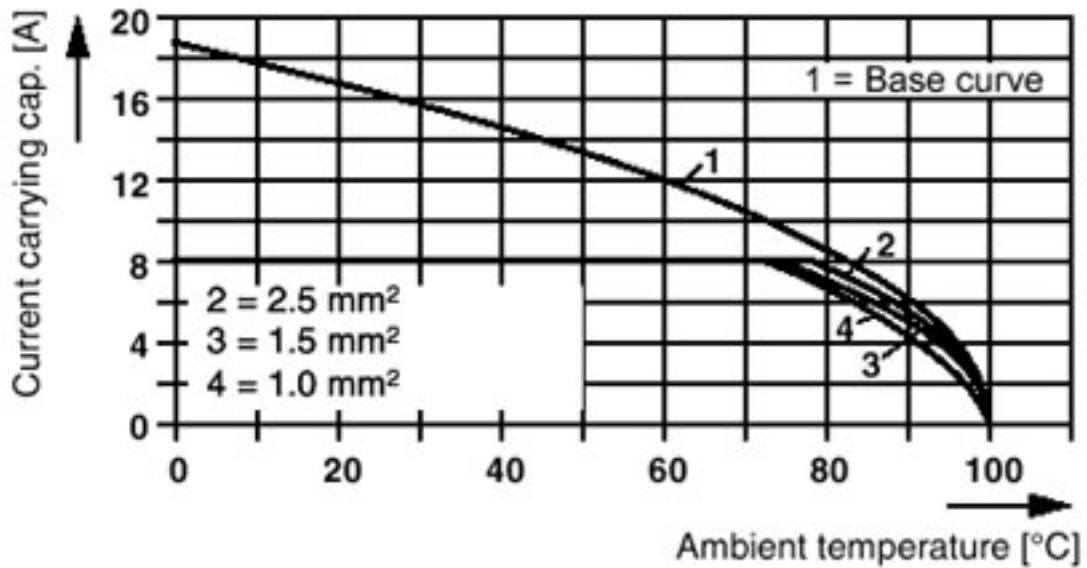

# Base strip - MSTBA 2,5/12-G-5,08 - 1757349

Diagram

Plug: MSTB 2,5/5-ST(F)-(-5,08)  
Header: MSTB(A) 2,5/5-G(F)-(-5,08)

