



Ledman Optoelectronic Co.,Ltd.

SPECIFICATIONS FOR LEDMAN SMD LED

Model No. : LS-AOEA-AEN1-01
Document No. : LMS-14-030
Revision No. : 03

Description:

- 3.5×2.8mm Top SMD
- Colloid Color: Water Transparent
- Emission Color: Amber
- Viewing Angle :120°

Dice Material: AlGaInP

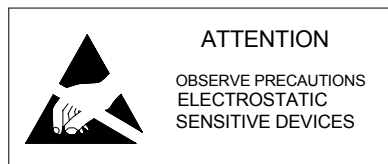

Add: Building 8,Block 2,Baimang Baiwangxin Industrial Park, Xili Area,Nanshan District,Shenzhen, P.R.China

Tel: 86-755-86139688

Fax: 86-755-86139001

Model No.:	LS-AOEA-AEN1-01
Document No.:	LMS-14-030
Revision No.:	03

Outline Drawing

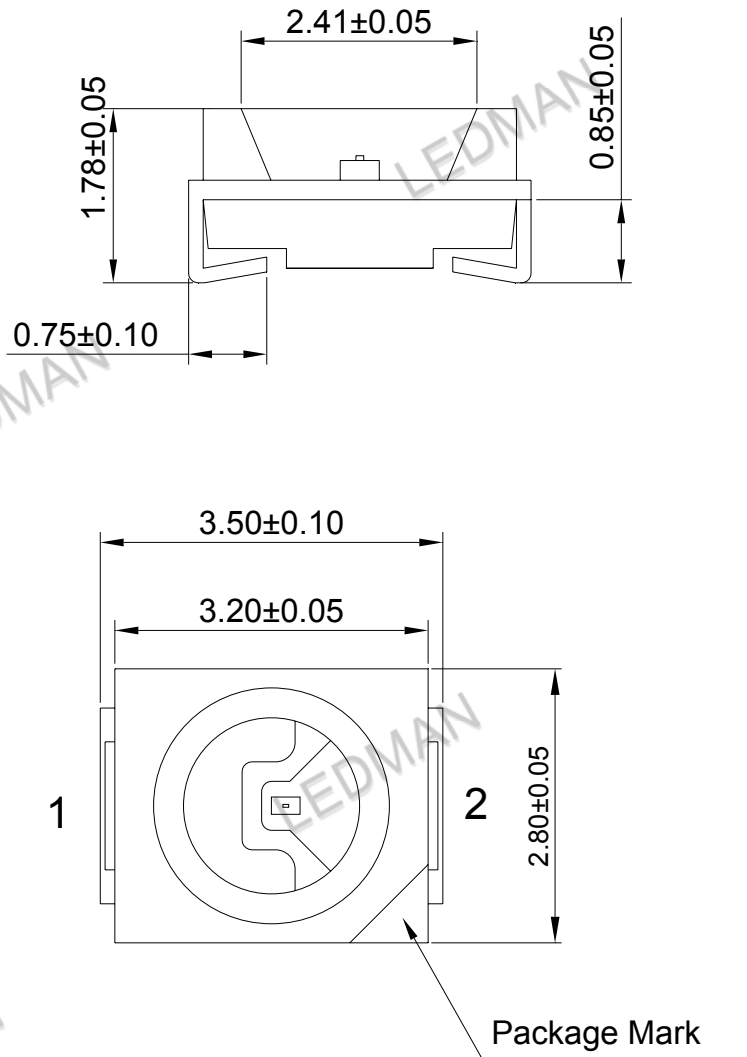

- 1.Cathode
- 2.Anode

NOTES:

All dimensions are in mm tolerance is ± 0.05 mm unless otherwise noted.



Model No.:	LS-AOEA-AEN1-01
Document No.:	LMS-14-030
Revision No.:	03

Applications:

1	Indicators
2	Illuminations
3	LCD Back Lights
4	Automobile's Applications

Absolute Maximum Ratings (Ta = 25°C)

Items	Symbol	Absolute maximum Rating	Unit
DC Forward Current	I_F	50	mA
Peak Forward Current*	I_{FP}	200	mA
Reverse Voltage	V_R	5	V
Power Dissipation	P_D	120	mW
Operation Temperature	T_{opr}	-40~ + 95	°C
Storage Temperature	T_{stg}	-40 ~ +100	°C

*pulse width ≤ 0.1 msec duty $\leq 1/10$

Typical Electrical & Optical Characteristics (Ta = 25°C)

Items	Symbol	Condition	Min.	Typ.	Max.	Unit
Forward Voltage	V_F	$I_F = 20$ mA	---	2.0	2.4	V
Reverse Current	I_R	$V_R = 5$ V	---	---	10	μ A
Luminous Intensity	I_V	$I_F = 20$ mA	450	560	---	mcd
Dominant Wavelength	λ_D	$I_F = 20$ mA	585	590	595	nm
50% Power Angle	$2\theta_{\frac{1}{2}}$	$I_F = 20$ mA	---	120	---	deg

Important Notes:

- 1) All data will be included per delivery; rank ratio will be based on Dices distribution.
- 2) Tolerance of measurement of luminous intensity is $\pm 10\%$.
- 3) Tolerance of measurement of Vf is ± 0.05 V.
- 4) Tolerance of measurement of dominant wavelength is ± 1 nm.
- 5) Reliability test conditions Please refer to " **Reliability Test**" section on page 5.
- 6) How to use Ledman LED product safely ,Please refer to " **Application Notes**" section on page 7 to 9 .
- 7) Packaging methods are available for selection; please refer to "**packing**" section on page 10.
- 8) Specifications are subject to change without notice.



Model No.:	LS-AOEA-AEN1-01
Document No.:	LMS-14-030
Revision No.:	03

Typical Optical-Electronic Characteristic Curves:

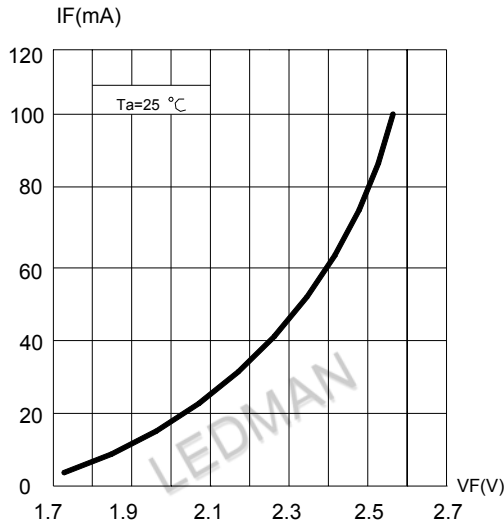

Fig.1 Forward Current vs. Forward Voltage

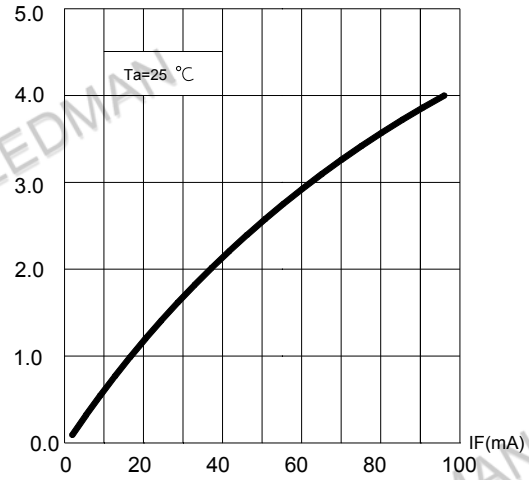

Fig.2 Relative Luminous Intensity vs. Forward Current
Domi WL=590nm

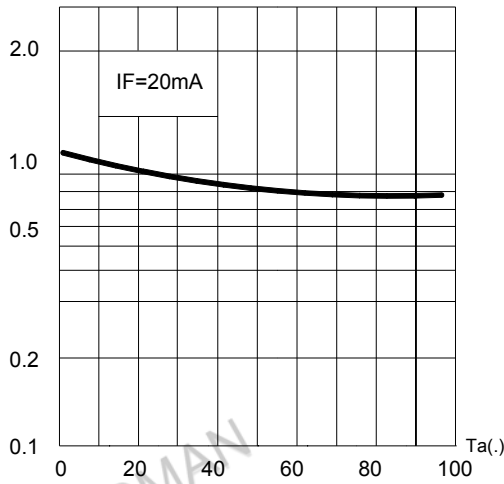

Fig.3 Relative Luminous Intensity vs. Ambient Temperature

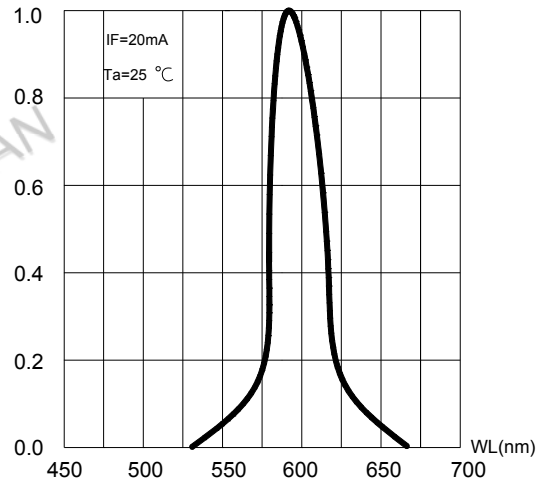

Fig.4 Relative Luminous Flux vs. Wavelength

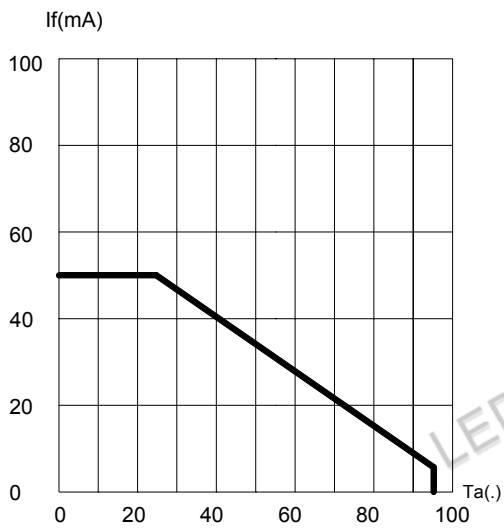

Fig.5 Maximum Forward Current vs. Ambient Temperature

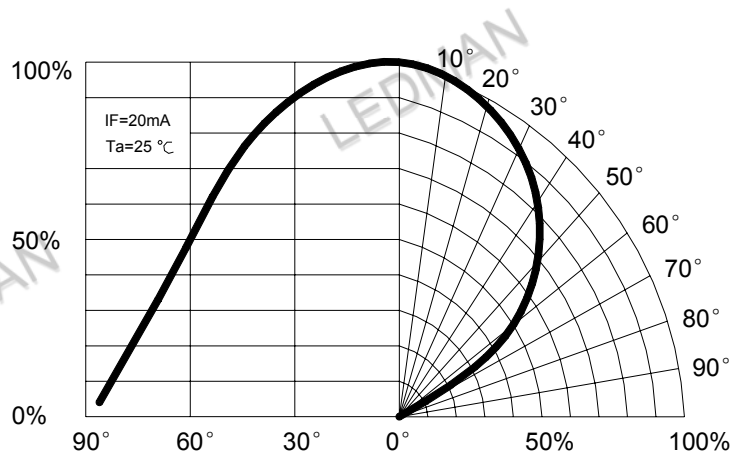

Fig.6 Relative Luminous Intensity vs. Radiation Angle



Model No.:	LS-AOEA-AEN1-01
Document No.:	LMS-14-030
Revision No.:	03

Reliability Test Standards

Test item:

Type	Test item	Applicable standard	Test condition	Duration	Sampling number	Accept criteria
environment test	Temperature cycles	JEITA ED-4701 100 105	-40℃~25℃~100℃~25℃ 30min 5min 30min 5min	100cycles	50	0/50
	Thermal shock	MIL-STD-202G	-40℃~100℃ 15min 15min	300cycles	50	0/50
	High humidity heat cycles	JEITA ED-4701 200 203	30℃~65℃ RH=90% 24hrs/1 cycle	50cycles	50	0/50
	High temperature storage	JEITA ED-4701 200 201	T _a =100℃	1000hrs	50	0/50
	Low temperature storage	JEITA ED-4701 200 202	T _a =-40℃	1000hrs	50	0/50
	High temperature & high humidity storage	JEITA ED-4701 100 103	T _a =60℃ RH=90%	1000hrs	50	0/50
life test	Normal temperature life test	/	T _a =25℃ I _F =30mA(R,G,Y)/20mA(W,B)	1000hrs	50	0/50
	High temperature & high humidity life test	/	T _a =60℃ RH=90% I _F =20mA(R,G,Y)/15mA(W,B)	1000hrs	50	0/50
	Low temperature life test	/	T _a =-30℃ I _F =20mA(R,G,Y)/15mA(W,B)	1000hrs	50	0/50
	High temperature life test	/	T _a =85℃ I _F =20mA(R,G,Y)/15mA(W,B)	1000hrs	50	0/50
destructive experiment	Resistance to soldering heat (Reflow soldering)	JEITA ED-4701 300 301	T _{sol} =260℃,10sec Pretreatment:30℃ 70%RH 168hrs	2 times	10	0/10
	Solderability	/	T _{sol} =235℃±5℃,5sec using flux	one time	10	0/10
ESD	Electrostatic discharge test	JEITA ED-4701 300 304	Human body model 1000V forward and reverse	each 3 times	10	0/10
physical experiment	Vibration	JEITA ED-4701 400 403	20G 20-2000HZ 4mins X,Y,Z 3directions	each 4cycles	10	0/10
	Drop	/	75CM	3 times	10	0/10

Failure Criteria:

Item	Symbol	Test condition	Criteria for Judgment
Forward Voltage	V _F	I _F =20mA	Initial Data±10%
Reverse Current	I _R	V _R =5V	≦10μA
Luminous Intensity	I _V	I _R =20mA	Single led degradation ≦50% and Average degradation ≦30%
Solderability			Over 95%
Vibration		I _F =20mA	No dead lamps or visual damage
Drop		I _F =20mA	No dead lamps or visual damage

Remark: RH:Environment humidity; T_a:Environment temperature;

T_{sol}:Tin temperature; I_F:Forward current; V_R:Reverse voltage.



Model No.:	LS-AOEA-AEN1-01
Document No.:	LMS-14-030
Revision No.:	03

SMD LED Product Naming Rule

L S — X X X X — X X X X — 0 1

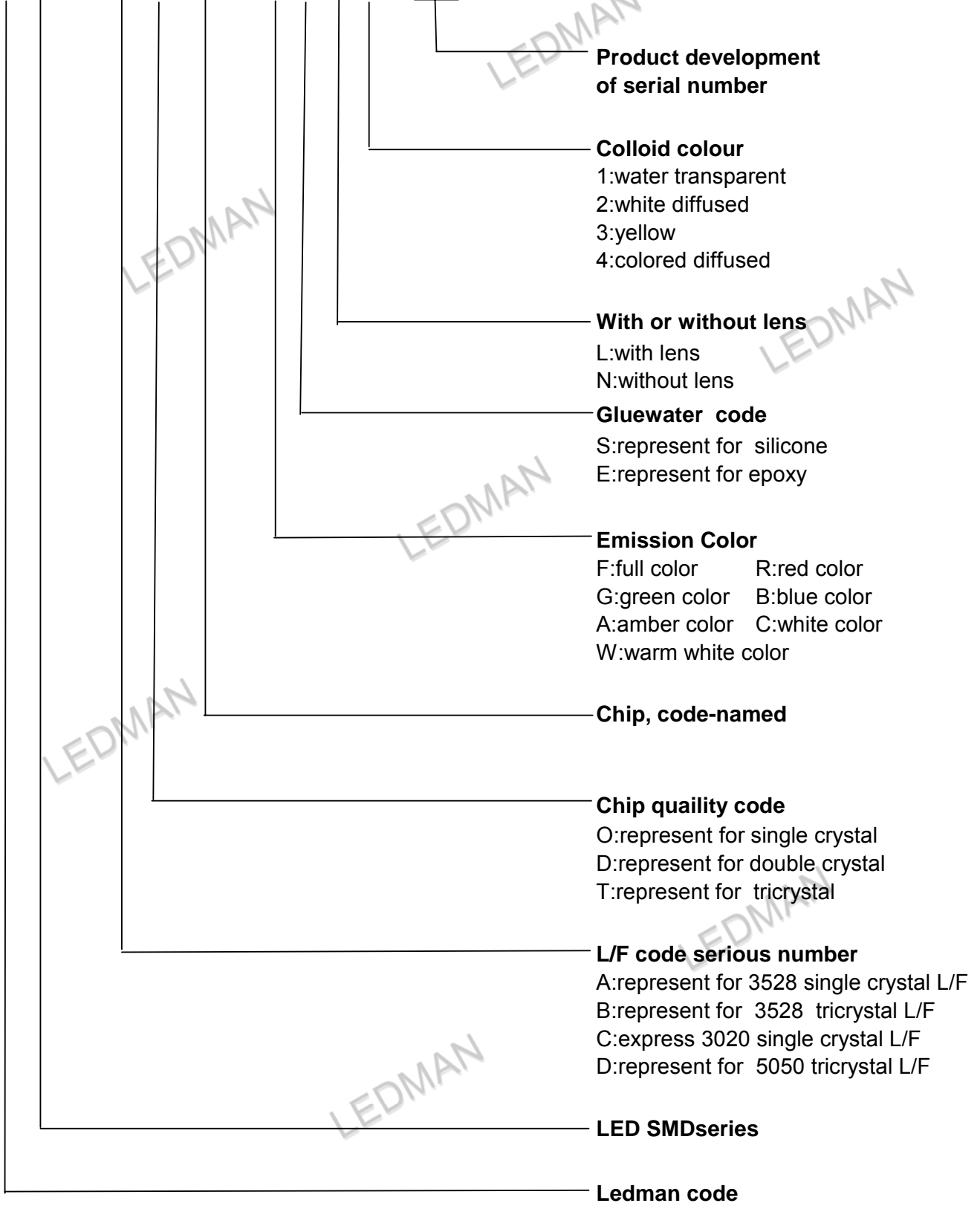



Model No.:	LS-AOEA-AEN1-01
Document No.:	LMS-14-030
Revision No.:	03

Application Note Application Note

Features

The purpose of this document is to provide a clear understanding to the customers and users, on the ways how to use our SMD lamps appropriately.

Description

Generally, SMD can be used the same way as other general-purpose semiconductors. When using Ledman's SMD LED, the following precautions must be taken to protect the SMD.

1. Cleaning

- ✧ Don't use unspecified chemical liquids to clean the SMD LED; the chemical could harm the SMD LED. When washing is necessary, please immerse the SMD LED in alcohol at normal room temperature for less than 1 minute and dry at normal room temperature for 15 minutes before use.
- ✧ The influence of ultrasonic cleaning on the SMD LED depending on factors such as ultrasonic power and the way SMD LED are mounted. Ultrasonic cleaning shall be pre-qualified to ensure this will not cause damage to the SMD LED.

2. Moisture Proof Packing

- ✧ In order to prevent moisture absorption into SMD LED during the transportation and storage, SMD LED is packed in a moisture barrier bag. Desiccants and a humidity indicator are packed together with SMD LED as the secondary protection. The indication of humidity indicator card provides the information of humidity within SMD packing.

3. Storage

- ✧ Shelf life in original sealed bag at storage condition of $<40^{\circ}\text{C}$ and $<90\%RH$ is 12 months. Baking is required whenever shelf life is expired.
- ✧ Before opening the packaging, Please check whether bag leak air or not.
- ✧ After bag opening, the SMD LED must be stored under the condition $<30^{\circ}\text{C}$ and $<60\%RH$. Under this condition, SMD LED must be used (subject to reflow) within 24 hours after bag opening, and re-baking is required when exceeding 24 hours.
- ✧ For baking, place SMD LED in oven at temperature $70^{\circ}\text{C}\pm 5^{\circ}\text{C}$ and relative humidity $\leq 10\%RH$, for 24 hours.
- ✧ Take out the material from packaging bag for re-bake. Do not open the door of oven frequently during the baking process.

4. Soldering

. Manual soldering by soldering iron

- ◇ The use of a soldering iron of less than 25W is recommended and the temperature of the iron must be kept at below 315°C, with soldering time within 2 seconds.
- ◇ The epoxy resin of SMD LED should not be in contact with tip of soldering iron.
- ◇ No mechanical stress should be exerted on the resin portion of SMD LED during soldering.
- ◇ Handling of SMD LED should be done when the package has been cooled down to below 40°C or less. This is to prevent the SMD LED failures due to thermal-mechanical stress during handling.

. Reflow Soldering

- ◇ The temperature (Top surface of SMD LED) profile is as below:

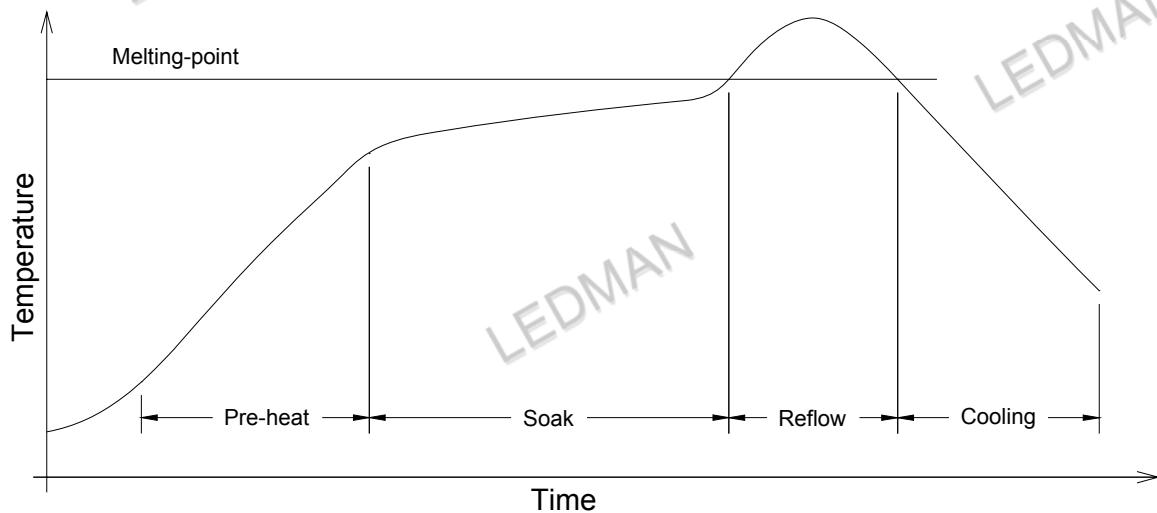

Solder = Sn63-Pb37	Solder = Lead-free
Average ramp-up rate = 4°C/s max.	Average ramp-up rate = 4°C/s max
Preheat temperature = 100°C ~150°C	Preheat temperature = 150°C ~200°C
Preheat time = 100s max.	Preheat time = 100s max.
Ramp-down rate = 6°C/s max.	Ramp-down rate = 6°C/s max.
Peak temperature = 230°C max.	Peak temperature = 250°C max.
Time within 5°C of actual Peak Temperature = 10s max.	Time within 5°C of actual Peak Temperature = 10s max.
Duration above 183°C is 80s max.	Duration above 217°C is 80s max.

Model No.:	LS-AOEA-AEN1-01
Document No.:	LMS-14-030
Revision No.:	03

◇ Recommended solder pad design for heat dissipation:

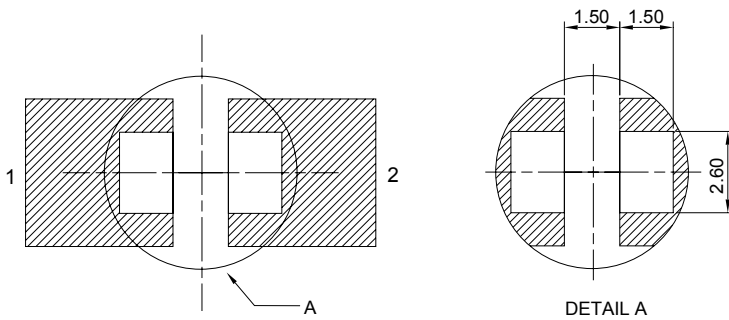

Note:
Metal area at 1,2 should not be less than 16mm² each for sufficient heat dissipation.

- ◇ Modification is not recommended on SMD LED after soldering. If modification cannot be avoided, the modifications must be pre-qualified to avoid damaging SMD LED.
- ◇ Reflow soldering should not be done more than one time.
- ◇ No stress should be exerted on the package during soldering.
- ◇ PCB should not be wrapped after soldering; this is to allow natural cooling of the PCB board and SMD LED.

5. Electrostatic Discharge and Surge current

- ◇ Electrostatic discharge (ESD) or surge current (EOS) may damage SMD LED.
- ◇ Precautions such as ESD wrist strap, ESD shoe strap or antistatic gloves must be worn whenever handling of SMD LED.
- ◇ All devices, equipment and machinery must be properly grounded.
- ◇ It is recommended to perform electrical test to screen out ESD failures at final inspection.
- ◇ It is important to eliminate the possibility of surge current during circuitry design

6. Heat Management

Heat management of SMD LED must be taken into consideration during the design stage of SMD LED application. The current should be de-rated appropriately by referring to the de-rating curve attached on each product specification.

Model No.:	LS-AOEA-AEN1-01
Document No.:	LMS-14-030
Revision No.:	03

Packaging

- ✧ The boxes are not water-resistant, and they must be kept away from water and moisture.
- ✧ The LEDs are packed in cardboard boxes after packaging in normal or anti-electrostatic bags.
- ✧ Cardboard boxes will be used to protect the LEDs from mechanical shocks during transportation.
- ✧ The polyethylene bag back is applied in SMD LED.
- ✧ 2000+2(spare) pcs per reel.
- ✧ 10 reel per B carton.
- ✧ 20 reel per C carton

