

SIPMOS® Power Transistor

BUZ 30 A

- N channel
- Enhancement mode
- Avalanche-rated

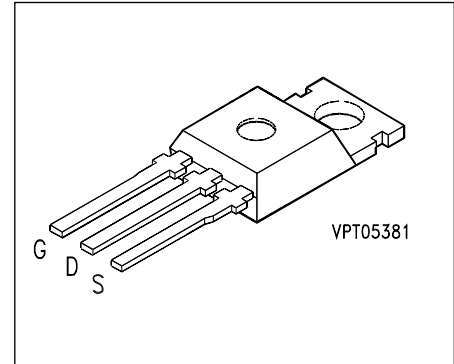

Type	V_{DS}	I_D	$R_{DS(on)}$	Package ¹⁾	Ordering Code
BUZ 30 A	200 V	21 A	0.13 Ω	TO-220 AB	C67078-S1303-A3

Maximum Ratings

Parameter	Symbol	Values	Unit
Continuous drain current, $T_C = 26\text{ }^\circ\text{C}$	I_D	21	A
Pulsed drain current, $T_C = 25\text{ }^\circ\text{C}$	$I_{D\text{ puls}}$	84	
Avalanche current, limited by $T_{j\text{ max}}$	I_{AR}	21	
Avalanche energy, periodic limited by $T_{j(max)}$	E_{AR}	12	mJ
Avalanche energy, single pulse $I_D = 21\text{ A}$, $V_{DD} = 50\text{ V}$, $R_{GS} = 25\text{ }\Omega$ $L = 1.53\text{ mH}$, $T_j = 25\text{ }^\circ\text{C}$	E_{AS}	450	
Gate-source voltage	V_{GS}	± 20	V
Power dissipation, $T_C = 25\text{ }^\circ\text{C}$	P_{tot}	125	W
Operating and storage temperature range	T_j, T_{stg}	- 55 ... + 150	$^\circ\text{C}$

Thermal resistance, chip-case	$R_{th\text{ JC}}$	≤ 1.0	K/W
DIN humidity category, DIN 40 040		E	-
IEC climatic category, DIN IEC 68-1		55/150/56	

1) See chapter Package Outlines.

Electrical Characteristics

at $T_j = 25\text{ °C}$, unless otherwise specified.

Parameter	Symbol	Values			Unit
		min.	typ.	max.	

Static characteristics

Drain-source breakdown voltage $V_{GS} = 0\text{ V}, I_D = 0.25\text{ mA}$	$V_{(BR)DSS}$	200	–	–	V
Gate threshold voltage $V_{GS} = V_{DS}, I_D = 1\text{ mA}$	$V_{GS(th)}$	2.1	3.0	4.0	
Zero gate voltage drain current $V_{DS} = 200\text{ V}, V_{GS} = 0\text{ V}$ $T_j = 25\text{ °C}$ $T_j = 125\text{ °C}$	I_{DSS}	– –	0.1 10	1.0 100	μA
Gate-source leakage current $V_{GS} = 20\text{ V}, V_{DS} = 0\text{ V}$	I_{GSS}	–	10	100	nA
Drain-source on-resistance $V_{GS} = 10\text{ V}, I_D = 13.5\text{ A}$	$R_{DS(on)}$	–	0.10	0.13	Ω

Dynamic characteristics

Forward transconductance $V_{DS} \geq 2 \times I_D \times R_{DS(on)max}, I_D = 13.5\text{ A}$	g_{fs}	6	15	–	S
Input capacitance $V_{GS} = 0\text{ V}, V_{DS} = 25\text{ V}, f = 1\text{ MHz}$	C_{iss}	–	1400	1900	pF
Output capacitance $V_{GS} = 0\text{ V}, V_{DS} = 25\text{ V}, f = 1\text{ MHz}$	C_{oss}	–	280	400	
Reverse transfer capacitance $V_{GS} = 0\text{ V}, V_{DS} = 25\text{ V}, f = 1\text{ MHz}$	C_{rss}	–	130	200	
Turn-on time $t_{on}, (t_{on} = t_{d(on)} + t_r)$ $V_{DD} = 30\text{ V}, V_{GS} = 10\text{ V}, I_D = 3\text{ A}, R_{GS} = 50\text{ }\Omega$	$t_{d(on)}$	–	30	45	ns
	t_r	–	70	110	
Turn-off time $t_{off}, (t_{off} = t_{d(off)} + t_f)$ $V_{DD} = 30\text{ V}, V_{GS} = 10\text{ V}, I_D = 3\text{ A}, R_{GS} = 50\text{ }\Omega$	$t_{d(off)}$	–	250	320	
	t_f	–	90	120	

Electrical Characteristics (cont'd)at $T_j = 25\text{ °C}$, unless otherwise specified.

Parameter	Symbol	Values			Unit
		min.	typ.	max.	
Reverse diode					
Continuous reverse drain current $T_C = 25\text{ °C}$	I_S	–	–	21	A
Pulsed reverse drain current $T_C = 25\text{ °C}$	I_{SM}	–	–	84	
Diode forward on-voltage $I_S = 42\text{ A}$, $V_{GS} = 0\text{ V}$	V_{SD}	–	1.2	1.6	V
Reverse recovery time $V_R = 10\text{ V}$, $I_F = I_S$, $di_F / dt = 100\text{ A}/\mu\text{s}$	t_{rr}	–	180	–	ns
Reverse recovery charge $V_R = 10\text{ V}$, $I_F = I_S$, $di_F / dt = 100\text{ A}/\mu\text{s}$	Q_{rr}	–	1.2	–	μC

Characteristics at $T_j = 25^\circ\text{C}$, unless otherwise specified.

Total power dissipation

$$P_{\text{tot}} = f(T_C)$$

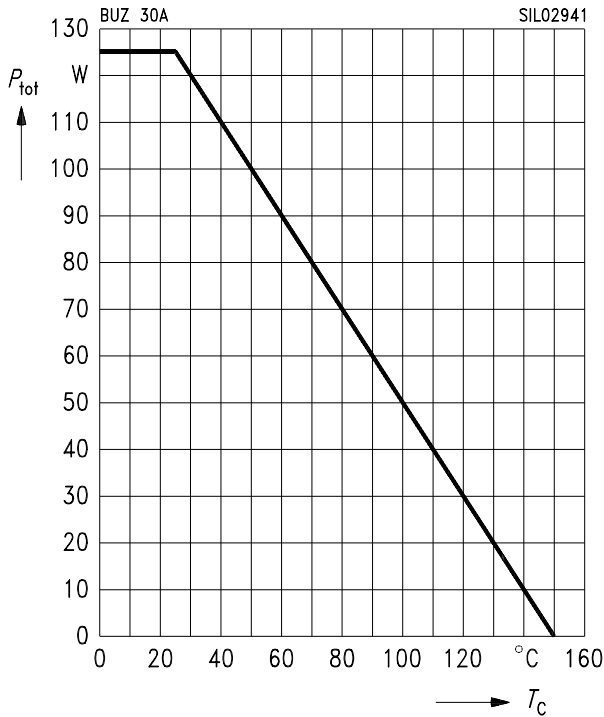

Typ. output characteristics

$$I_D = f(V_{\text{DS}})$$

parameter: $t_p = 80 \mu\text{s}$

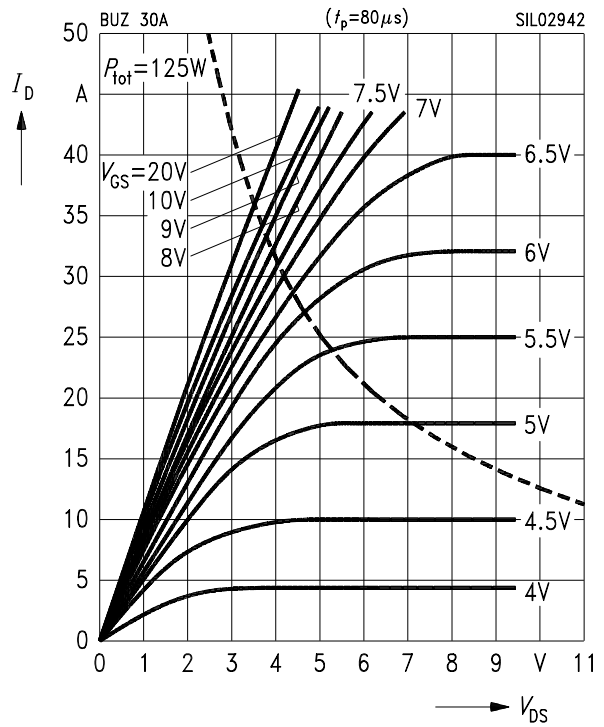

Safe operating area

$$I_D = f(V_{\text{DS}})$$

parameter: $D = 0.01$, $T_C = 25^\circ\text{C}$

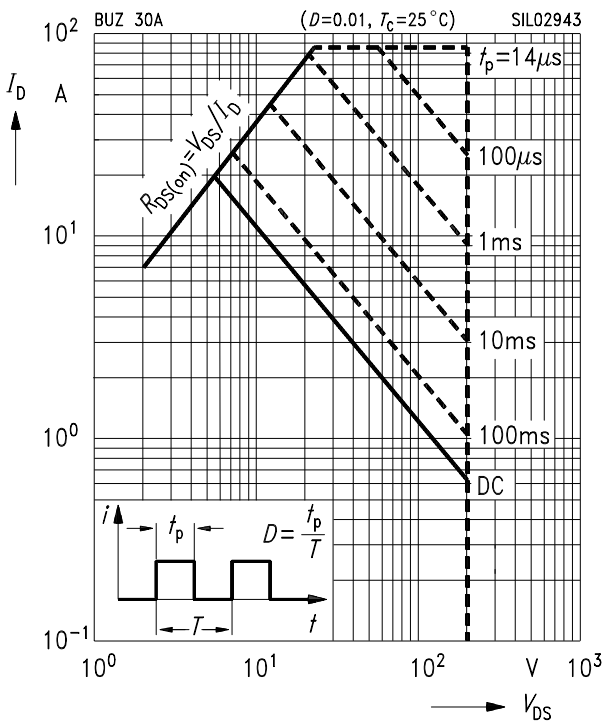

Typ. transfer characteristics

$$I_D = f(V_{\text{GS}})$$

parameter: $t_p = 80 \mu\text{s}$, $V_{\text{DS}} = 25\text{V}$

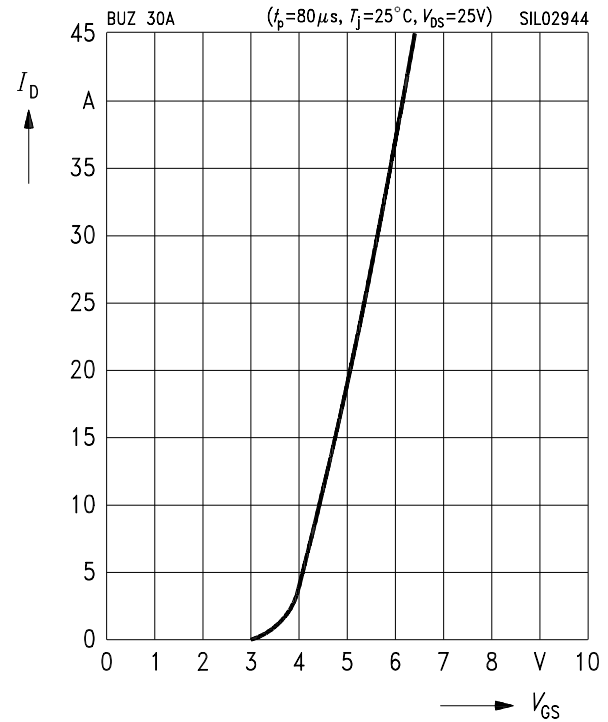

Typ. drain-source on-resistance

$R_{DS(on)} = f(I_D)$

parameter: V_{GS}

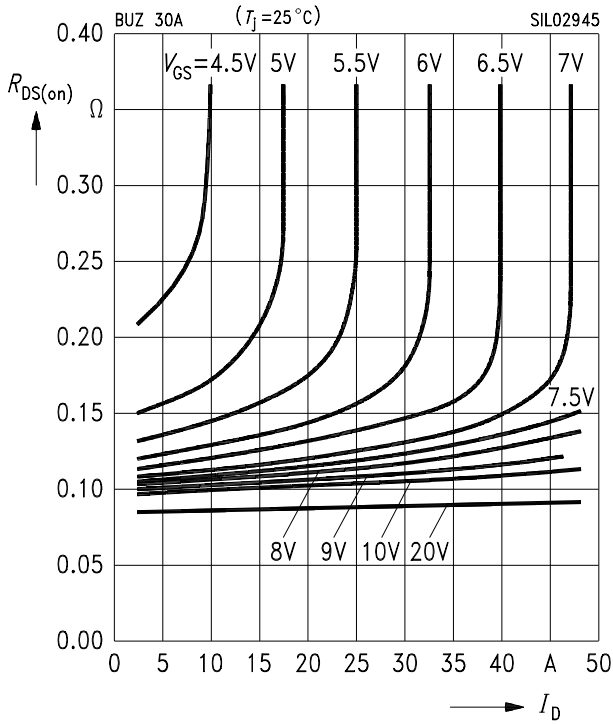

Drain-source on-resistance

$R_{DS(on)} = f(T_j)$

parameter: $I_D = 13.5\text{ A}$, $V_{GS} = 10\text{ V}$, (spread)

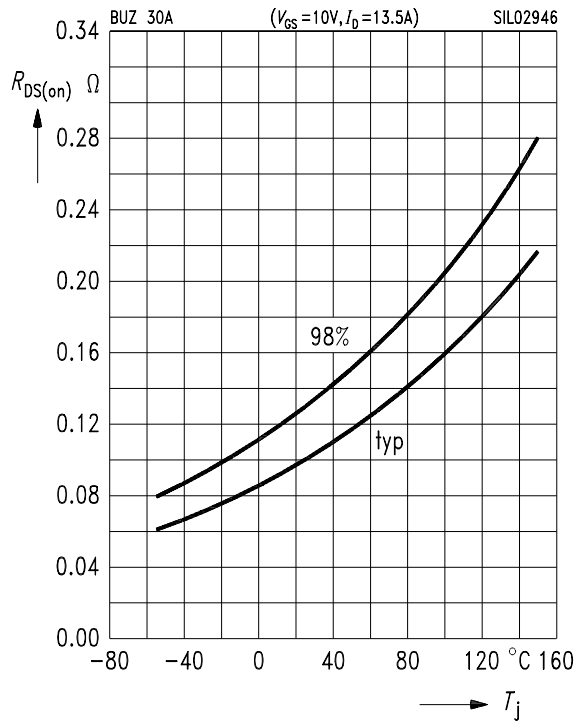

Typ. forward transconductance

$g_{fs} = f(I_D)$

parameter: $t_p = 80\ \mu\text{s}$

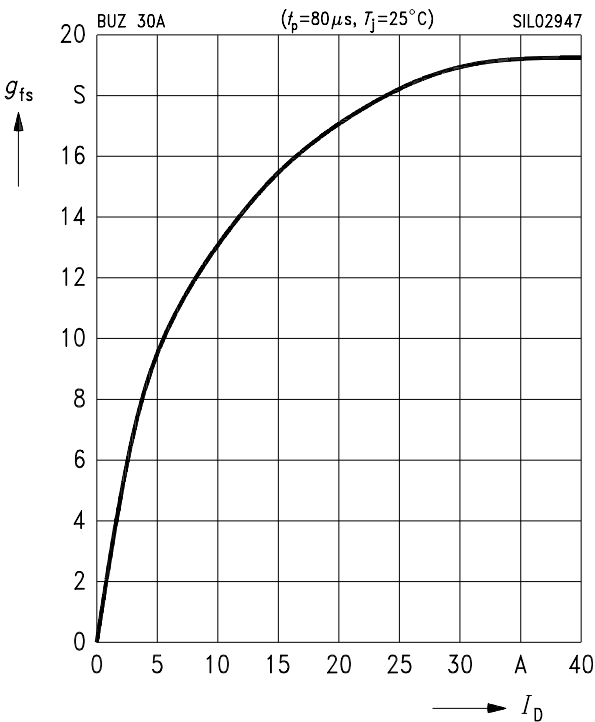

Gate threshold voltage

$V_{GS(th)} = f(T_j)$

parameter: $V_{GS} = V_{DS}$, $I_D = 1\text{ mA}$, (spread)

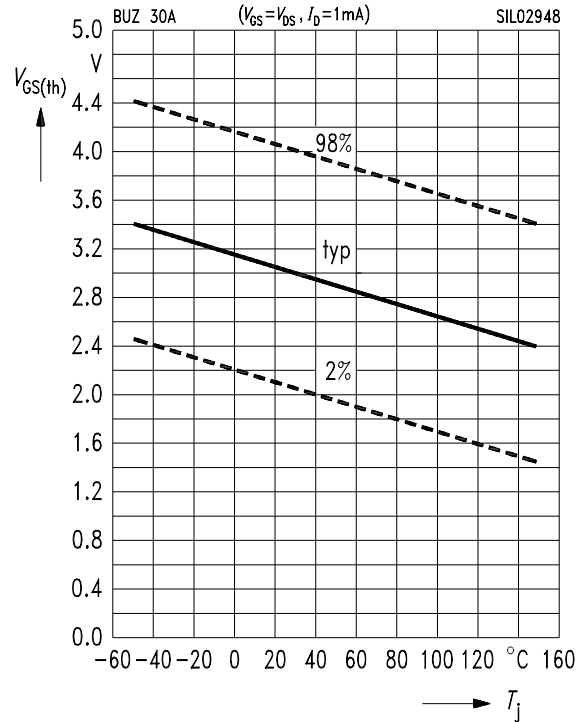

Typ. capacitances

$$C = f(V_{DS})$$

parameter: $V_{GS} = 0 \text{ V}$, $f = 1 \text{ MHz}$

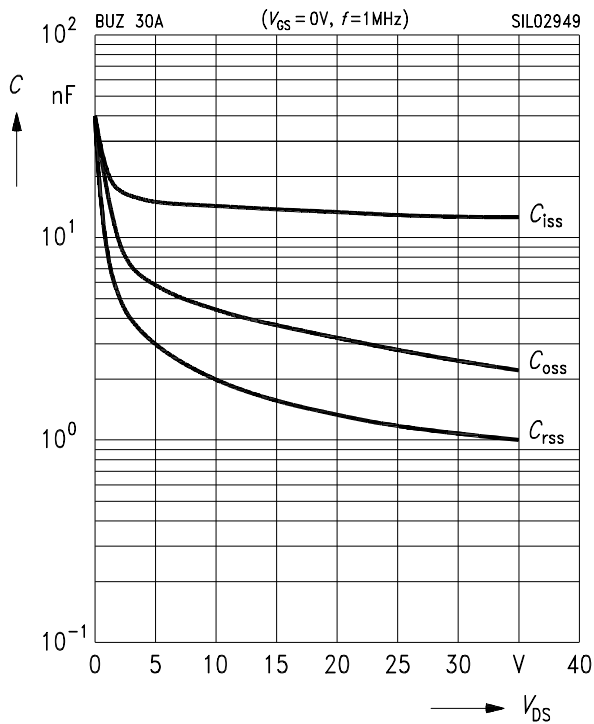

Drain current

$$I_D = f(T_C)$$

parameter: $V_{GS} \geq 10 \text{ V}$

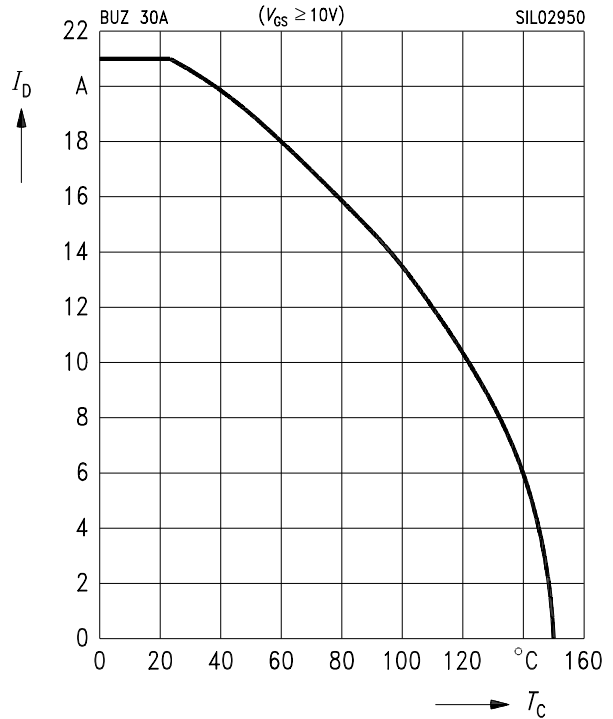

Forward characteristics of reverse diode

$$I_F = f(V_{SD})$$

parameter: $T_j, t_p = 80 \mu\text{s}$, (spread)

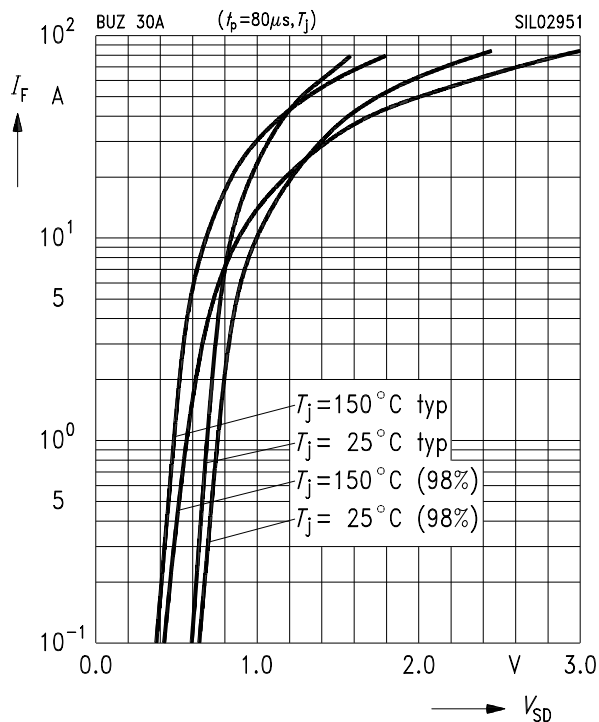

Avalanche energy $E_{AS} = f(T_j)$

parameter: $I_D = 21 \text{ A}$, $V_{DD} = 50 \text{ V}$

$R_{GS} = 25 \Omega$, $L = 1.53 \text{ mH}$

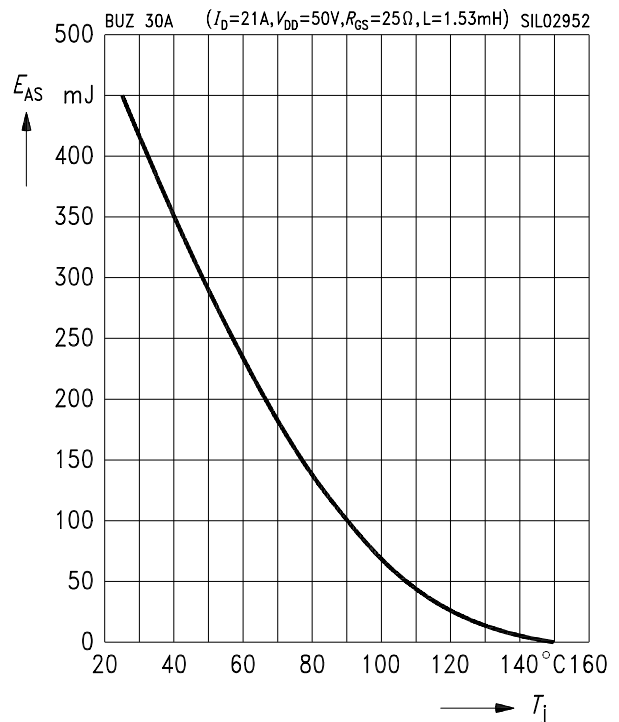

Transient thermal impedance

$$Z_{thJC} = f(t_p)$$

parameter: $D = t_p / T$

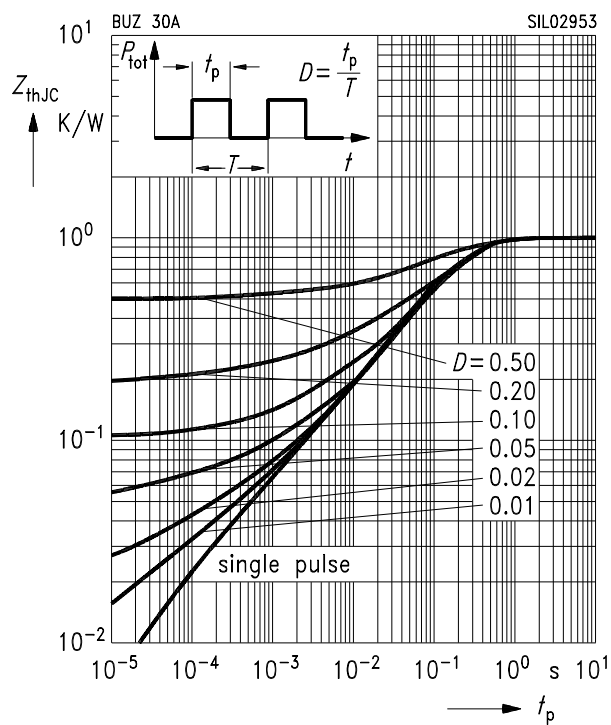

Typ. gate charge

$$V_{GS} = f(Q_{Gate})$$

parameter: $I_{D\ puls} = 31.5\ A$

