

## IGBT MODULE ( L series)

### ■ Features

- High Speed Switching
- Low Saturation Voltage
- Voltage Drive

### ■ Applications

- Inverter for Motor Drive
- AC and DC Servo Drive Amplifier
- Uninterruptible Power Supply
- Industrial Machines, such as Welding Machines

### ■ Maximum Ratings and Characteristics

#### ● Absolute Maximum Ratings

Items	Symbols	Ratings	Units
Collector-Emitter Voltage	$V_{CES}$	600	V
Gate-Emitter Voltage	$V_{GES}$	$\pm 20$	V
Collector Current	Continuous	$I_c$	150
	1ms	$I_{c\ pulse}$	300
	Continuous	$-I_c$	150
	1ms	$-I_{c\ pulse}$	300
Max. Power Dissipation	$P_c$	600	W
Operating Temperature	$T_j$	+150	°C
Storage Temperature	$T_{stg}$	-40 to +125	°C
Net. Weight		340	g
Isolation Voltage	AC. 1min.	$V_{isol}$	2500
Screw Torque	Mounting *1	35	kg*cm
	Terminals *1	35	

\*1 Recommendable Value 25 to 35kg\*cm (M5)

#### ● Electrical Characteristics ( $T_j=25^\circ\text{C}$ )

Items	Symbols	Test Conditions	Min.	Typ.	Max.	Units
Zero Gate Voltage Collector Current	$I_{CES}$	$V_{GE}=0V$ $V_{CE}=600V$ $T_j=25^\circ\text{C}$			2.0	mA
Gate-Emitter Leakage Current	$I_{GES}$	$V_{CE}=0V$ $V_{GE}=\pm 20V$			200	nA
Gate-Emitter Threshold Voltage	$V_{GE(th)}$	$V_{CE}=20V$ $I_c=150mA$	3.0		6.0	V
Collector-Emitter Saturation Voltage	$V_{CE(sat)}$	$V_{GE}=15V$ $I_c=150A$			3.5	V
Input Capacitance	$C_{ies}$	$V_{GE}=0V$		14250		pF
Output Capacitance	$C_{oes}$	$V_{CE}=10V$		-		
Reverse Transfer Capacitance	$C_{res}$	$f=1MHz$		-		
Turn-on Time *2	$t_{on}$	$V_{CC}=300V$		0.6	0.8	$\mu\text{s}$
	$t_r$	$I_c=150A$		0.4	0.6	
Turn-off Time *3	$t_{off}$	$V_{GE}=\pm 15V$		0.7	1.0	
	$t_f$	$R_G=12\Omega$		0.2	0.35	
Diode Forward On-Voltage	$V_F$	$I_F=150A$ $V_{GE}=0V$			2.5	V
Reverse Recovery Time	$t_{rr}$	$I_F=150A$ $-di/dt=450A/\mu\text{s}$ $V_{GE}=-10V$			300	ns

\*2 Resistive load

\*3 Inductive load

#### ● Thermal Characteristics

Items	Symbols	Test Conditions	Min.	Typ.	Max.	Units
Thermal Resistance	$R_{th(j-c)}$	IGBT			0.208	°C/W
	$R_{th(j-d)}$	Diode			0.40	
	$R_{th(c-f)}$	With Thermal compound		0.025		

### ■ Outline Drawings

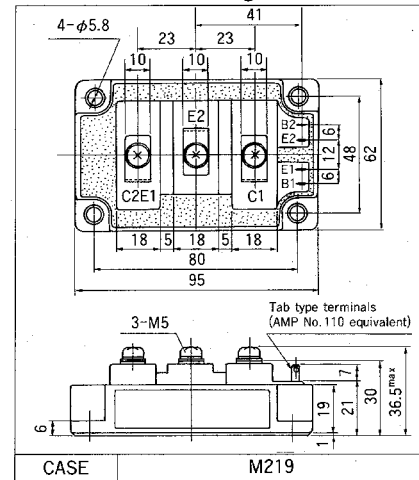

### ■ Equilavent Circuit Schematic

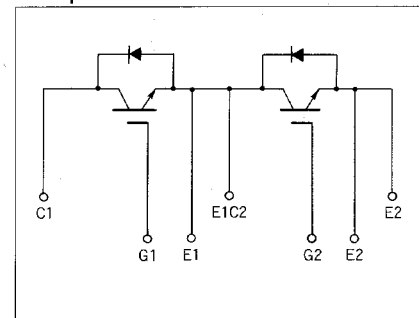

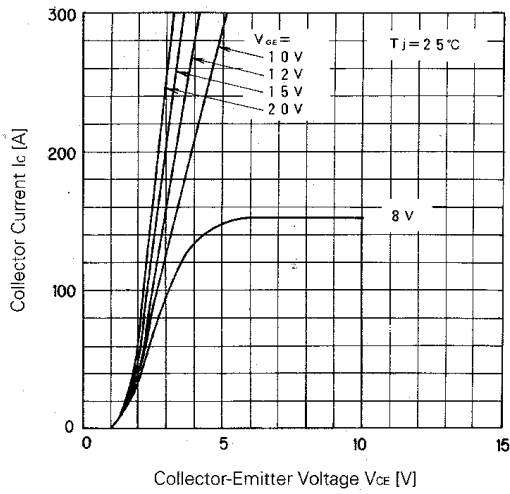

Collector Current vs. Collector-Emitter Voltage

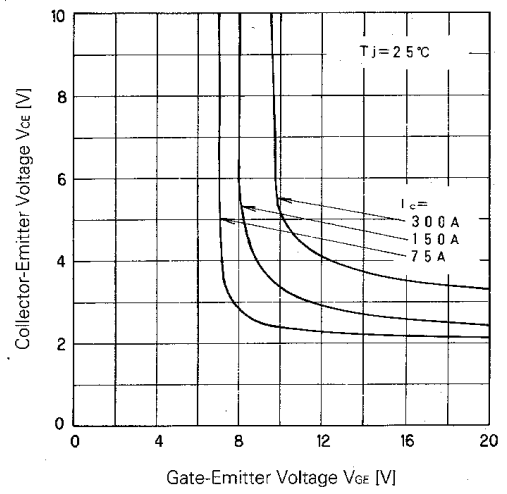

Collector-Emitter Voltage vs. Gate-Emitter Voltage

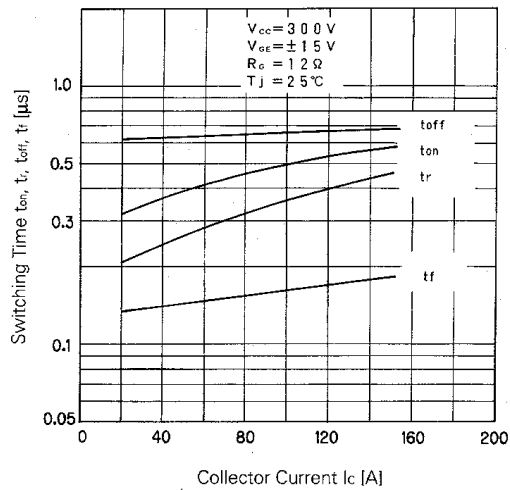

Switching Time

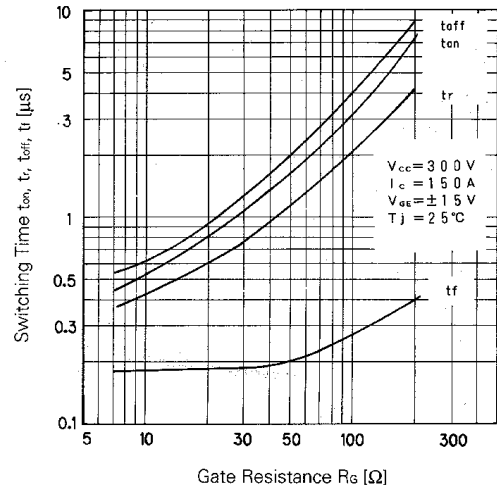

Switching Time-Gate Resistance

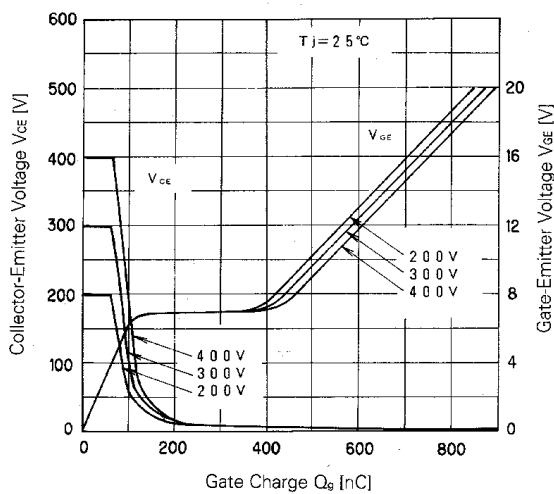

Dynamic Input Characteristic

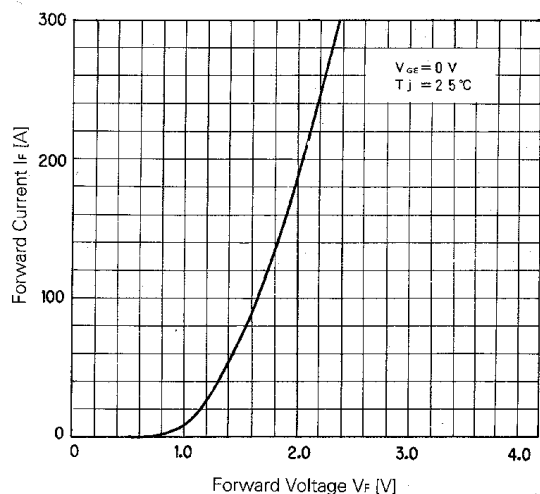

Forward Voltage of Free Wheel Diode

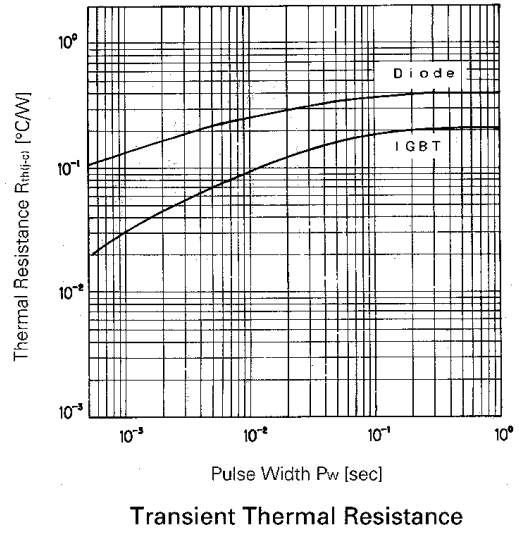
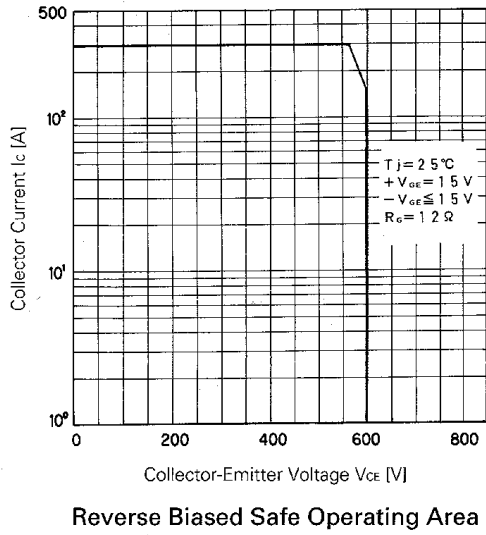
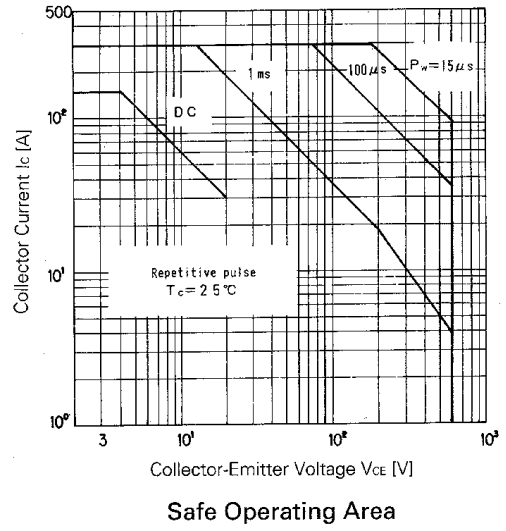
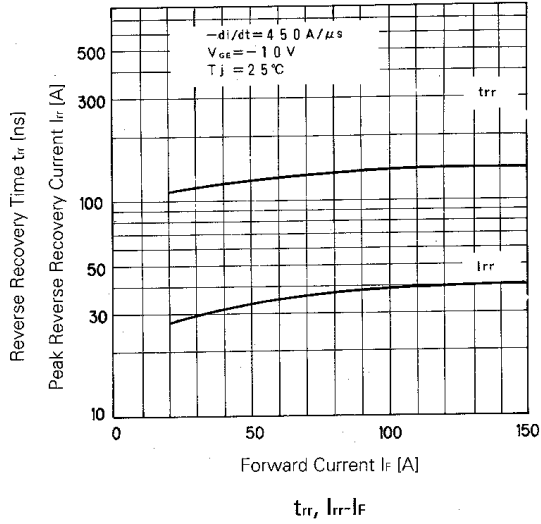

For more information, contact:

**Collmer Semiconductor, Inc.**

P.O. Box 702708

Dallas, TX 75370

972-733-1700

972-381-9991 Fax

<http://www.collmer.com>