

FAST SOFT-RECOVERY RECTIFIER DIODES

Glass-passivated double-diffused rectifier diodes in TO-238 envelope, featuring fast reverse recovery times with soft recovery characteristics.

They are primarily intended for use in a.c. motor control systems as an anti-parallel diode to switching devices such as GTO, ASCR, etc. They are also suitable for use in high-frequency inverters. The envelope baseplate is electrically isolated.

QUICK REFERENCE DATA

		BYV60-850			1000	1200
Repetitive peak reverse voltage	V_{RRM}	max.	850	1000	1200	
Average forward current	$I_F(AV)$	max.		15		A
Non-repetitive peak forward current	I_{FSM}	max.		150		A
Reverse recovery time	t_{rr}	<		0.6		μs

MECHANICAL DATA

Dimensions in mm

Fig.1 TO-238 (2-pin)

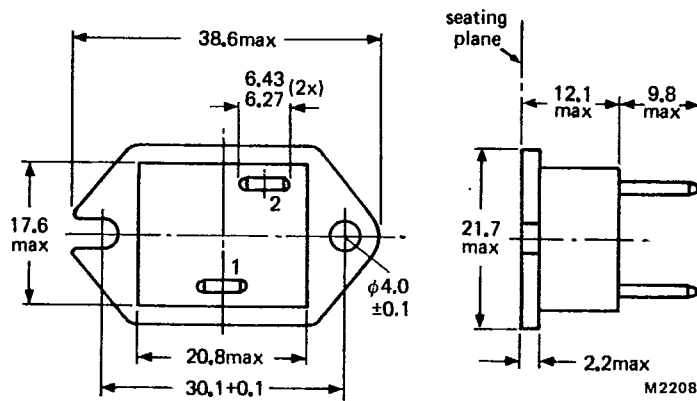

Pin 1 = cathode (AMO 250 series)
 Pin 2 = anode (AMP 250 series)
 Baseplate is electrically isolated.

Net mass = 16.5 g

BYV60 SERIES

90D 10395 D T-03-17

RATINGS

Limiting values in accordance with the Absolute Maximum System (IEC 134)

Voltages

		BYV60-850	1000	1200	
Non-repetitive peak reverse voltage	V_{RSM}	max. 1000	1100	1300	V
Repetitive peak reverse voltage	V_{RRM}	max. 850	1000	1200	V
Crest working reverse voltage	V_{RWM}	max. 600	800	1000	V
Continuous reverse voltage	V_R	max. 500	650	750	V

Currents

Average forward current assuming zero switching losses

square-wave; $\delta = 0.5$; up to $T_{mb} = 76^\circ C$
 sinusoidal; up to $T_{mb} = 81^\circ C$

$I_F(AV)$	max.	15	A
$I_F(AV)$	max.	13.5	A

R.M.S. forward current

$I_F(RMS)$	max.	21	A
------------	------	----	---

Repetitive peak forward current;
 $1 \mu s < t_p < 1 ms; \delta \leq 0.02$

I_{FRM}	max.	300	A
-----------	------	-----	---

Non-repetitive peak forward current; $t = 10 ms$
 half sine-wave; $T_j = 125^\circ C$ prior to surge;
 with reapplied $V_{RWM} max$

I_{FSM}	max.	150	A
-----------	------	-----	---

Temperatures

Storage temperature

T_{stg}		-40 to +125	$^\circ C$
-----------	--	-------------	------------

Junction temperature

T_j	max.	125	$^\circ C$
-------	------	-----	------------

THERMAL RESISTANCE

From mounting base to heatsink;
 with heatsink compound

$R_{th mb-h}$	=	0.3	K/W
---------------	---	-----	-----

From junction to mounting base

$R_{th j-mb}$	=	2	K/W
---------------	---	---	-----

ISOLATION*

R.M.S. isolation voltage

V_{isol}	min.	2500	V
------------	------	------	---

*From baseplate to terminals strapped together.

Fast high-voltage rectifier diodes

90D 10396 D T.03-17

BYV60 SERIES

CHARACTERISTICS

Forward voltage $I_F = 50 \text{ A}; T_j = 25 \text{ }^\circ\text{C}$	$V_F < 2.45 \text{ V}^*$
Reverse current $V_R = V_{RWMmax}; T_j = 100 \text{ }^\circ\text{C}$	$I_R < 1.2 \text{ mA}$
Reverse recovery when switched from $I_F = 2 \text{ A}$ to $V_R \geq 30 \text{ V}$ with $-dI_F/dt = 20 \text{ A}/\mu\text{s}; T_j = 25 \text{ }^\circ\text{C}$	$Q_s < 2.0 \mu\text{C}$
recovered charge	$t_{rr} < 0.6 \mu\text{s}$
recovery time	
Forward recovery when switched to $I_F = 5 \text{ A}$ with $t_r = 0.1 \mu\text{s}; T_j = 25 \text{ }^\circ\text{C}$	$t_{fr} < 1.0 \mu\text{s}$
recovery time	

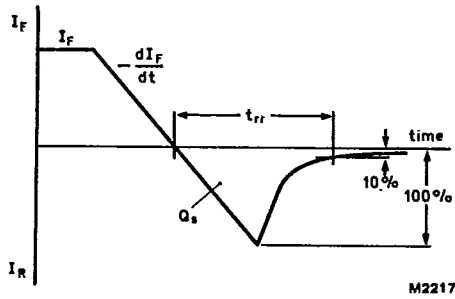

Fig.2 Definition of t_{rr} and Q_s .

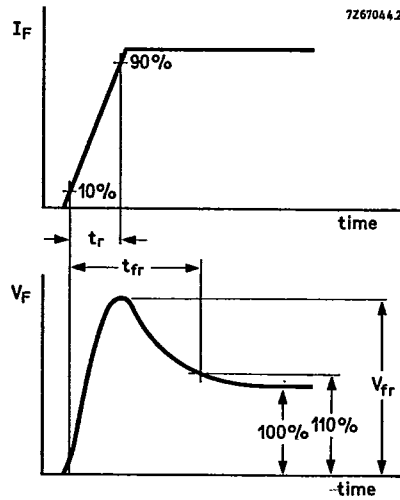

Fig.3 Definition of t_{fr} .

*Measured under pulse conditions, to avoid excessive dissipation.

SINUSOIDAL OPERATION

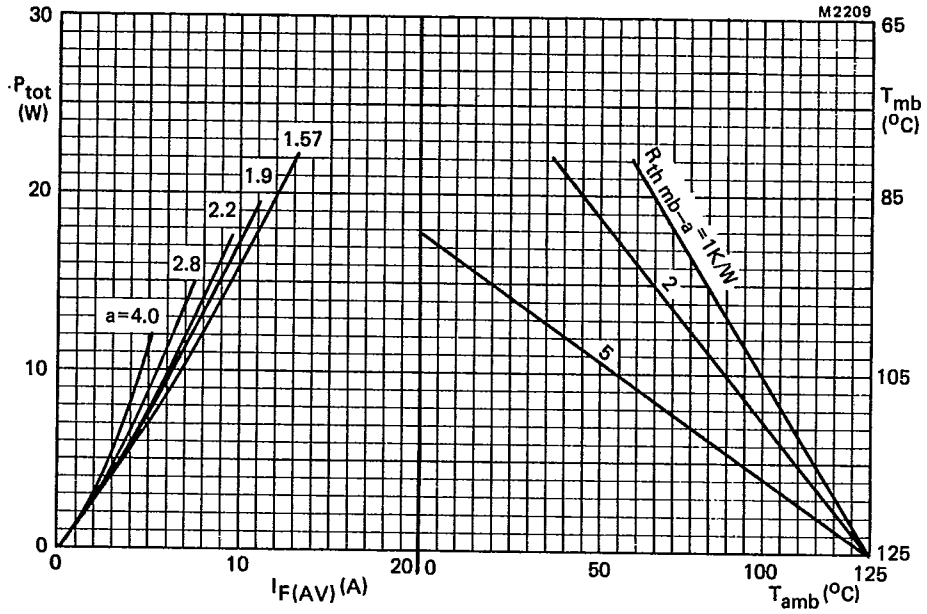

Fig.4 The right-hand part shows the interrelationship between the power (derived from the left-hand part) and the maximum permissible temperatures.
 P = power including reverse current losses but excluding switching losses.
 a = form factor = $I_F(RMS)/I_F(AV)$.

T-03-17

BYV60 SERIES

SQUARE-WAVE OPERATION

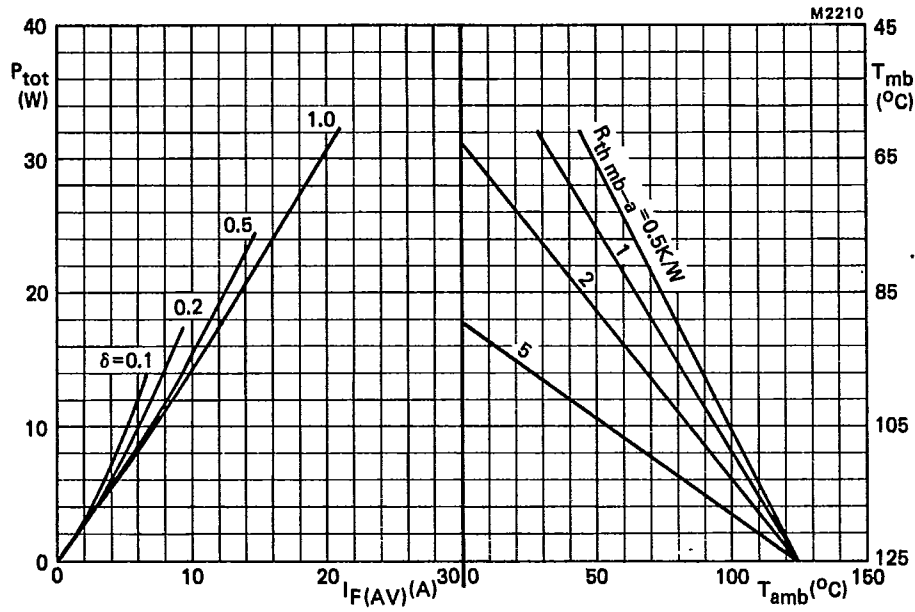
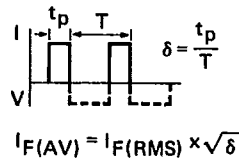

Fig.5 The right-hand part shows the interrelationship between the power (derived from the left-hand part) and the maximum permissible temperatures.
 P = power including reverse current losses but excluding switching losses.



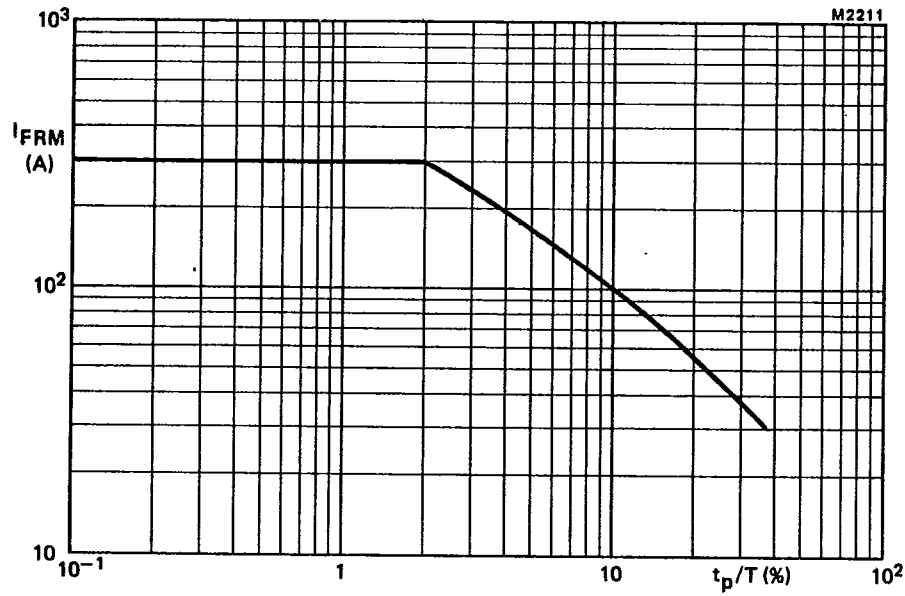

Fig. 6 Maximum permissible repetitive peak forward current based on sinusoidal currents; $1 \mu s < t_p < 1 ms$.

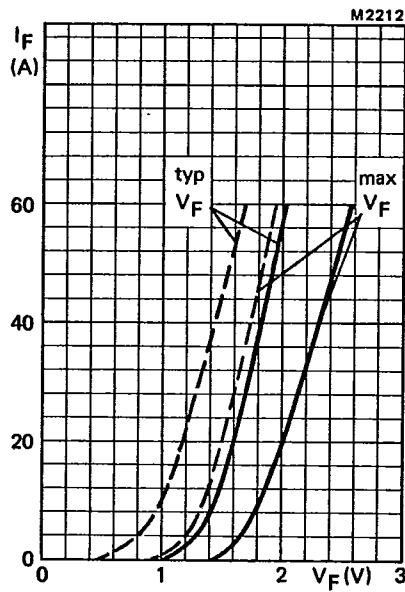

Fig. 7 ——— $T_j = 25^\circ C$; - - - - $T_j = 100^\circ C$.

Fast high-voltage rectifier diodes

90D 10400

D T-03-17

BYV60 SERIES

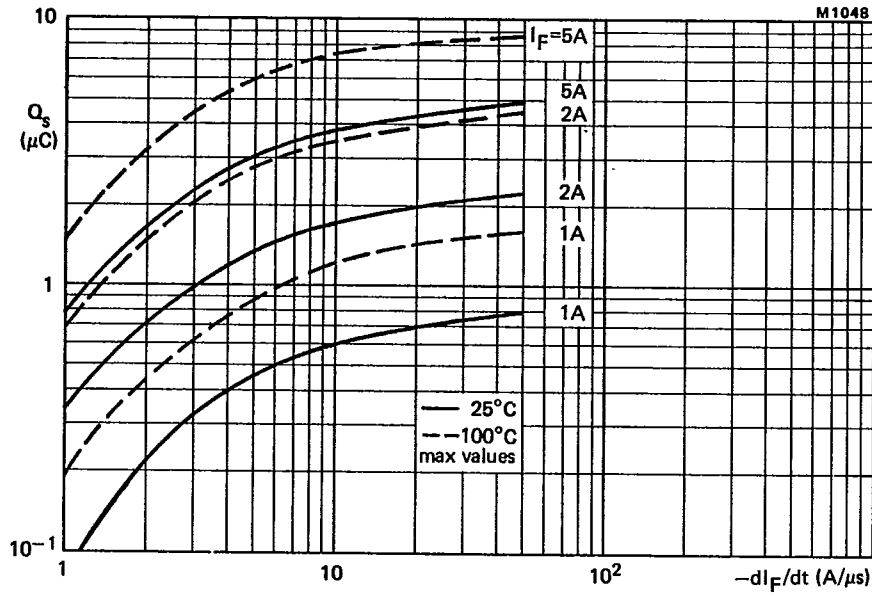

Fig.8

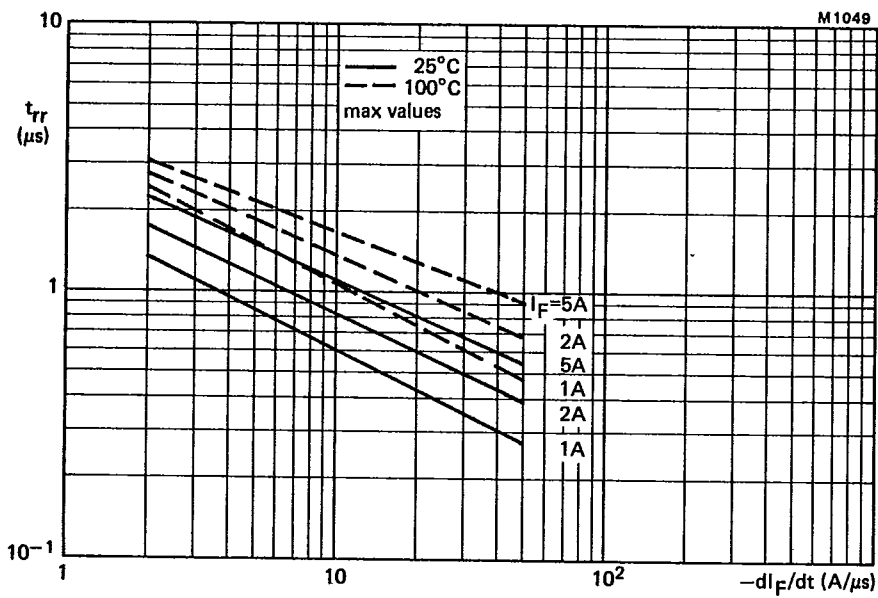

Fig.9

BYV60 SERIES

90D 10401 D T.03-17

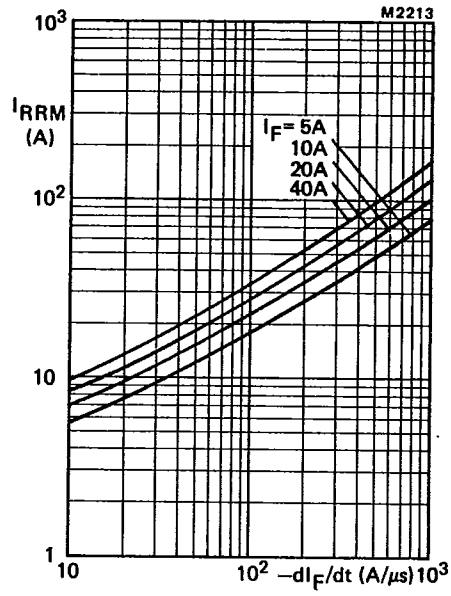

Fig.10