



SUZHOU PF MOTOR & FAN TECHNOLOGY CO.,LTD

DC BLOWER

75x75x30mm



UNITS:mm

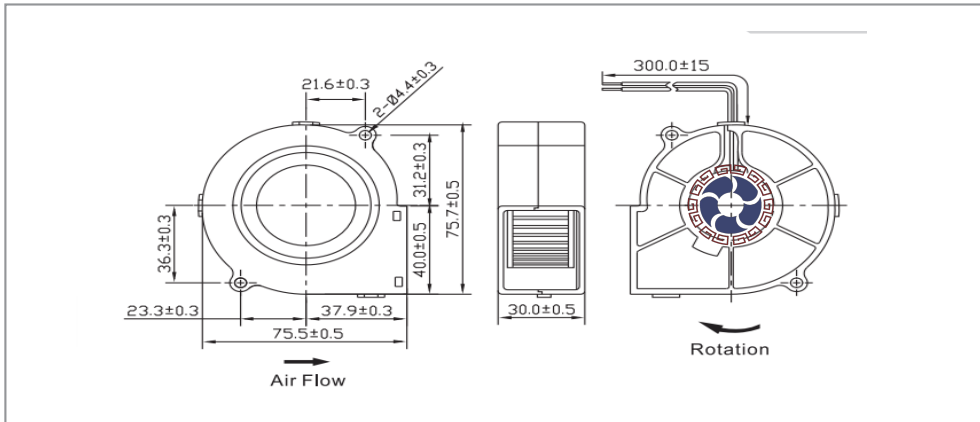

Model 型号	Size 尺寸	Rating Voltage (VDC) 电压	Power Current (AMP) 电流	Power Consumption (WATTS) 功率	Speed (RPM) 转速	Air Flow (CFM) 风量	Noise (dBA) 噪音	Bearing 轴承	Weight (g) 重量
PF7530D12HSL	75X75X30	12	0.20	2.40	3500	12.3	43	SLEEVE	75
PF7530D12HBL	75X75X30	12	0.20	2.40	3500	12.3	43	BALL	75
PF7530D24HSL	75X75X30	24	0.10	2.40	3500	12.3	43	SLEEVE	75
PF7530D24HBL	75X75X30	24	0.10	2.40	3500	12.3	43	BALL	75