

IVT-S // HIGH PRECISION CURRENT MEASUREMENT

1.	Introduction	1
2.	Application	1
3.	Functionality description	2
4.	Measurement description	5
5.	Technical Data.....	11
6.	Mechanical data	13
7.	Part description / Ordering	18
8.	CANbus protocol	19
9.	Startup	41
10.	Qualification	42
11.	Index	44

1. Introduction

The IVT-S is a high precision current measurement system, designed for DC applications, especially for automotive application. The product is based on a modular design and provides flexibility for fast adaptations to meet customer requirements in the automotive and the industrial area. The continuous current measurement has a range up to ± 2500 A. At higher currents (i.e. peaks) the measurement range will extend automatically.

The shunt-based measurement method uses a 16-bit analog-digital-converter to transform the voltage drop into a digital signal. The communication is based on a CAN bus 2.0a interface. A CAN description file (CAN-dbc) is available and supports fast system integration.



2. Application

The IVT-S is designed for a wide range of DC applications.

For example:

- Hybrid and full electric drives
- Uninterruptible Power Supply (UPS) systems
- Stationary energy storage systems
- Fuel cells
- All battery and storage based applications

3. Functionality description

3.1. Measurement modes

- Disable
- Trigger
- Cycle running

It is possible to configure each channel individually.

Disable mode

The measurement channel is disabled. The channel does not react to a software command or hardware trigger.

Trigger mode

The module sends a measurement result message in response to a received trigger command. This command is a software message.

Cycle running mode

The module sends a measurement result message after a configured cycle time.

Example: current channel cycle time: 10 ms.

Every 10 ms a measurement result message for the current channel is generated and transmitted over CAN.

3.2. Output signals

Channel	Unit
Current	A
Voltage 1	V
Voltage 2	V
Voltage 3	V
Temperature	°C
Power	W
Current counter	As
Energy counter	Wh

3.3. Internal Safety

The sensor status is internally monitored by the microcontroller. In case of a sensor failure a status bit is set.

To verify the current measurement of the first channel, a second virtually independent ADC channel is used. The system compares the signal of both channels to determinate malfunctions in the ADC. Furthermore the ADC's reference voltage is monitored. Therefore the IVT-S can detect a non-valid measurement condition on the current channel (see chapter 4.1.).

3.4. Log data

The log data are continually stored, with an interval of 15 minutes if the IVT-S is configured in run-mode. In case of a sensor reset, the last stored logdata will be recovered. It is possible to reset all logdata, as well as individual logdata.

The following logdata are available as 6-Byte values:

No	Item	Unit	Min	Max
1	Ampere hour counter overall (only if counter is activated)	As	- 72.000.000.000.000	+ 72.000.000.000.000
2	Ampere hour counter charging (only if counter is activated)	As	0	+ 144.000.000.000.000
3	Ampere hour counter discharging (only if counter is activated)	As	0	+ 144.000.000.000.000
4	Energy counter overall (only if counter is activated)	Wh	- 72.000.000.000.000	+ 72.000.000.000.000
5	Energy counter charging (only if counter is activated)	Wh	0	+ 144.000.000.000.000
6	Energy counter discharging (only if counter is activated)	Wh	0	+ 144.000.000.000.000
7	Runtime overall	s	0	+3.000.000.000
8	Runtime current measurement within specified limits	s	0	+3.000.000.000
9	Runtime current measurement outside specified limits	s	0	+3.000.000.000
10	Runtime voltage 1 measurement within specified limits	s	0	+3.000.000.000
11	Runtime voltage 1 measurement outside specified limits	s	0	+3.000.000.000
12	Runtime voltage 2 measurement within specified limits	s	0	+3.000.000.000
13	Runtime voltage 2 measurement outside specified limits	s	0	+3.000.000.000
14	Runtime voltage 3 measurement within specified limits	s	0	+3.000.000.000
15	Runtime voltage 3 measurement outside specified limits	s	0	+3.000.000.000
16	Runtime temperature measurement within specified limits	s	0	+3.000.000.000
17	Runtime temperature measurement outside specified limits	s	0	+3.000.000.000
18	Runtime oc positive activated	s	0	+3.000.000.000
19	Runtime oc negative activated	s	0	+3.000.000.000
20	Current measurement maximum	A	- 32.000	+ 32.000
21	Current measurement minimum	A	- 32.000	+ 32.000
22	U1 measurement maximum	V	- 32.000	+ 32.000

No	Item	Unit	Min	Max
23	U1 measurement minimum	V	- 32.000	+ 32.000
24	U2 measurement maximum	V	- 32.000	+ 32.000
25	U2 measurement minimum	V	- 32.000	+ 32.000
26	U3 measurement maximum	V	- 32.000	+ 32.000
27	U3 measurement minimum	V	- 32.000	+ 32.000
28	Temperature measurement maximum	1/10 °C	- 500	+ 2000
29	Temperature measurement minimum	1/10 °C	- 500	+ 2000

3.5. Firmware update

To update the firmware, the IVT has an implemented bootloader. Firmware update can only be done by Isabellenhütte.

3.6. Galvanic isolation

This functionality is designed for high voltage applications. With the isolation module the sensor can be used with different potential levels on power supply (low voltage side) and shunt (high voltage side).

Isolation voltage according DIN EN 60664-1:2008-01

Declarations are valid at the following condition:
Sea level under 2000m

Max Working Isolation Voltage	1000V RMS CATI 600V RMS CATI-II 300V RMS CATI-III
Basis Isolation DC Voltage	1000 V
Reinforced Isolation DC Voltage	600 V
Highest allowed transient overvoltage	6000V (for 1s)
Minimum External Clearance distance	> 40 mm
Minimum External Creepage distance	> 50 mm
Minimum Internal Clearance	8 mm
Material Group housing	IIIa
Material Group connectors	II



Note: For high voltages, it is recommended to use an insulation monitor.

3.7. Flammability

We confirm, that the IVT-S uses exclusively UL94-V0 materials. This applies to the following components:

- Housing
- Connectors
- PCB

3.8. Communication interface

The IVT-S uses the standard CAN 2.0 a protocol.

The complete protocol description is listed in chapter 8.

4. Measurement description

Depending on the selected functionality there are up to eight measurement output signals. Every signal can be configured individually (output transfer rate and value). Based on these variations a high number of applications are possible, i.e. a fast current measuring as well as a complete filtered measuring of all signals.

4.1. Sampling rates

Current measurement characteristics:

One ADC channel is only used for the current measurement, with a provided maximum output rate of one message per 1ms.

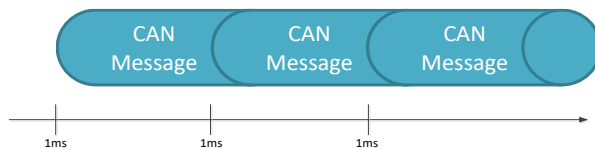

Figure 1: CAN-bus

Based on the configured measuring interval, the measurement result provides an average value of all single measurements within the interval (Figure 2). The use of higher sample reduces the noise level of the calculates measurement value.

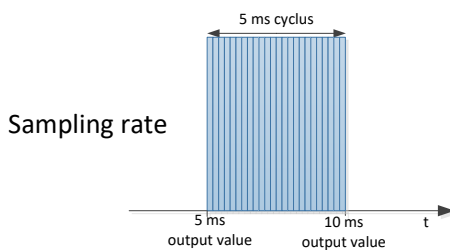

Figure 2: Averaging over 5 ms

Behavior ADC channel 1 and 2

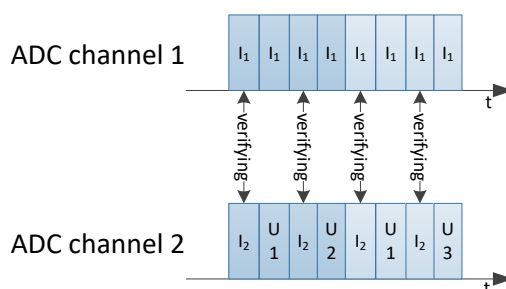

Figure 3: ADC channel 1 and 2

After every channel sampling, the current channel is additionally sampled for internal use (verifying current measurement for internal safety, see chapter 4.5).

Voltage measurement characteristics

The second ADC (ADC2) channel is used for voltage measurement. This channel is used for different signals, which are multiplexed.

This leads to the following behavior:

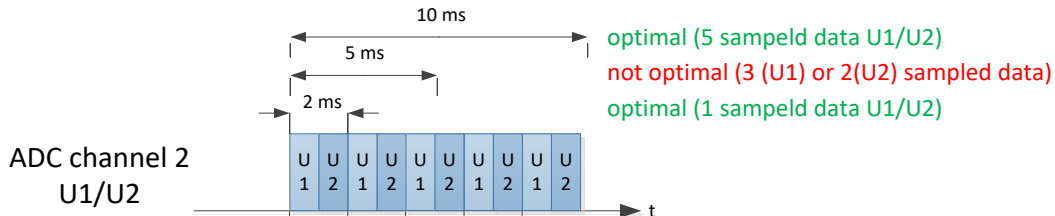

Figure 4: Example with two channel on ADC2

If two voltage channels are set, it is recommended to choose an output rate of a factor of 2. As can be seen in the Figure 4, one value is determined at an output rate of 2ms. With an output rate of 10 ms, the output value is averaged over 5 values.

If an output rate is not a multiple of the selected channels, according to time frame 3 values (U1) or a 2 value (U2) can be processed.

An output rate under 2 ms is not possible here.

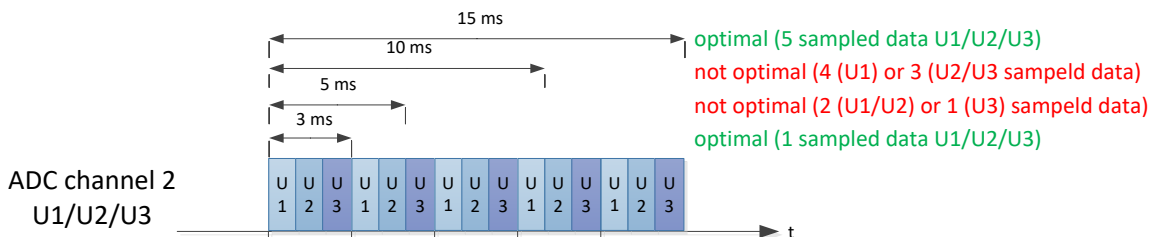

Figure 5: Example with three channel on ADC2

If three voltage channels are set, it is recommended to choose an output rate of factor three. As can be seen in the Figure 5 (3 ms), one value is determined at an output rate of 3 ms. With an output rate of 15 ms, the output value is averaged over 5 values.

If an output rate is not a multiple of the selected channels (e.g. 10 ms), according to time frame 4 values (U1) or a 3 value (U2/U3) can be processed.

An output rate under 3 ms is not possible here.

Example 1:

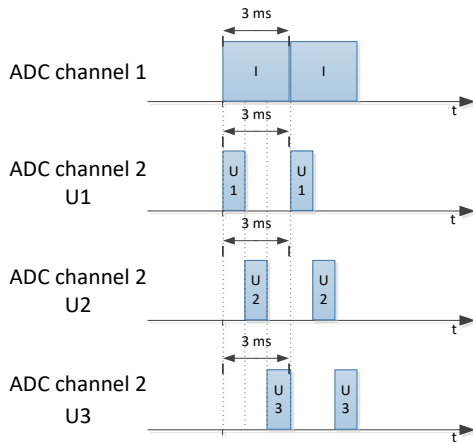

Figure 6: Configuration: 1 current channel, 3 voltage channel, 3 ms measurement interval

Figure 6 shows an example with 4 signals. All signals are configured with a measurement interval of 3 ms.

The current measurement extends over 3 ms.

The voltage measurement is multiplexed (U1, U2, U3).

Example 2:

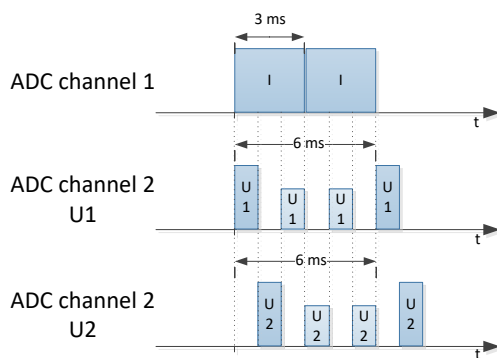

Figure 7: Configuration: 1 current channel, 2 voltage channel

Figure 7 shows an example with 3 signals. The current measure interval is 3 ms. The voltage measure interval is 6 ms.

The current measurement extends over 3 ms.

The voltage measurement multiplexes every 2 ms (U1, U2). After 6 ms the measured value is averaged over 3 values.

After evaluation of the configured measurement signals, the result messages of every signal will be generated and provide via CAN bus

Examples 3:

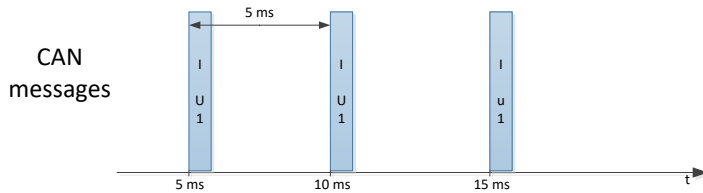

Figure 8: Two channels; 5 ms output rate

Configuration condition (Figure 8):

Two channels are configured, both with a measurement interval of 5 ms. In this case the sensor sends the current and voltage result every 5 ms.

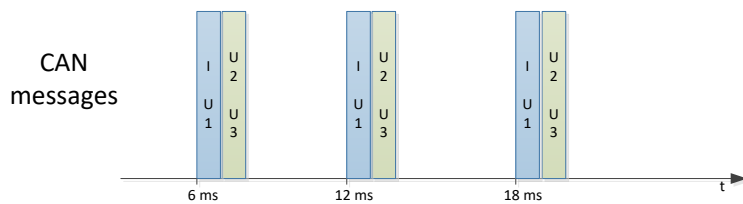

Figure 9: Four channels; 6 ms output rate

Configuration condition (Figure 9):

Four channels are configured; all with a measure interval of 6 ms. In this case the sensor sends a current result every 6 ms, and the voltage result U1, U2 and U3 every 6 ms, as well.

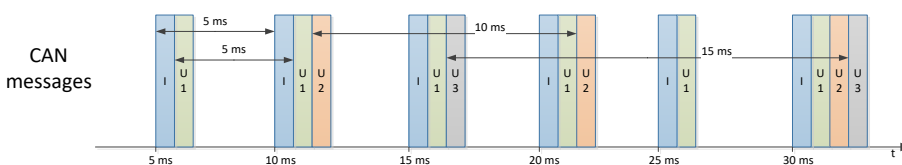

Figure 10: Four channels; different measure interval

Configuration condition (Figure 10):

Four channels are configured: Current channel (5ms interval), Voltage channel 1 with an measurement interval of 5 ms, Voltage channel 2 with an measurement interval of 10 ms and Voltage channel 3 with an measurement interval of 15 ms. In this case the sensor sends the current result every 5 ms and the voltage 1 result every 5 ms as well, every 10 ms Voltage 2 result and every 15 ms Voltage 3 result.

4.2. Overcurrent measurement

For overcurrent conditions the extended measurement range is used. As soon as the measured value exceeds the nominal range, the system switches over to the extended measurement range. The resolution decreases by factor 8.

Switching back to the nominal measuring range takes place when the measured values fall below the upper limit of the nominal measuring range by 5%. The extended measurement range is wider than the nominal measurement range by factor 8.

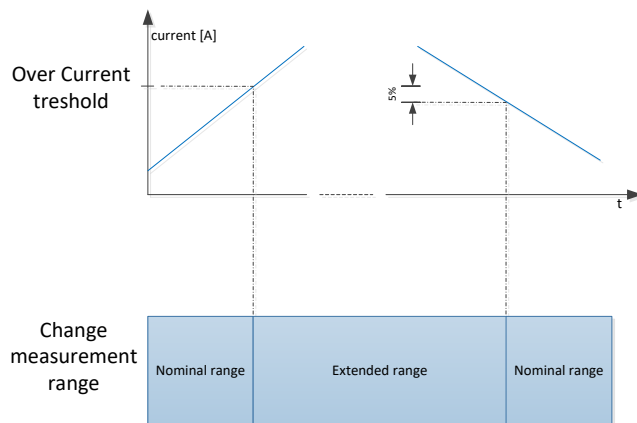

Figure 11: Change measurement range

4.3. Temperature calibration

Each measurement result can be influenced by shifting temperatures. For this reason, the IVT-S includes an internal temperature compensation to provide an optimized result in the complete defined temperature range.

4.4. Ranges

The IVT-S offers five different, customer selectable current measurement ranges. The selection of a required measurement range determines the shunt resistance.

Every shunt value has unique characteristics (see chapter 5 “technical data”). One limitation characteristic is the maximum load of the shunt resistor. The limitation is based on the internal thermal resistance and a maximum tolerable heating of 20 Kelvin.

Note:

To ensure that the measurement limits are in the specified range, care has to be taken to the thermal connection between shunt and busbar. In case of an inadequate shunt to busbar connection the sensor can possibly overheat due to the internal power dissipation.



4.5. Plausibility check (functional safety)

Since there are two independent ADC channels, the measured value from the first ADC channel is compared with the measured value from the second ADC channel. Both channels are also compared with the same bandgap (U_{ref}). Therefore a measurement drift between both channels, as well as a drift in the bandgap can be detected.

This plausibility check of the ADC provides a high reliability of the system over time and temperature. If there is a drift detected, a status bit within the result message is set to the corresponding issue (see chapter 8.1.).

4.6. Voltage measurement

For an optimized adaption to the application, there is the possibility to order the sensor with no (U0) or three (U3) voltage channels.

Each channel is individually configurable and voltage levels are measured with reference to sensor ground.

In every case, the 1st channel is used for the power measurement and has highest priority. Channel two and three are configured with a maximum output rate of 3 ms.

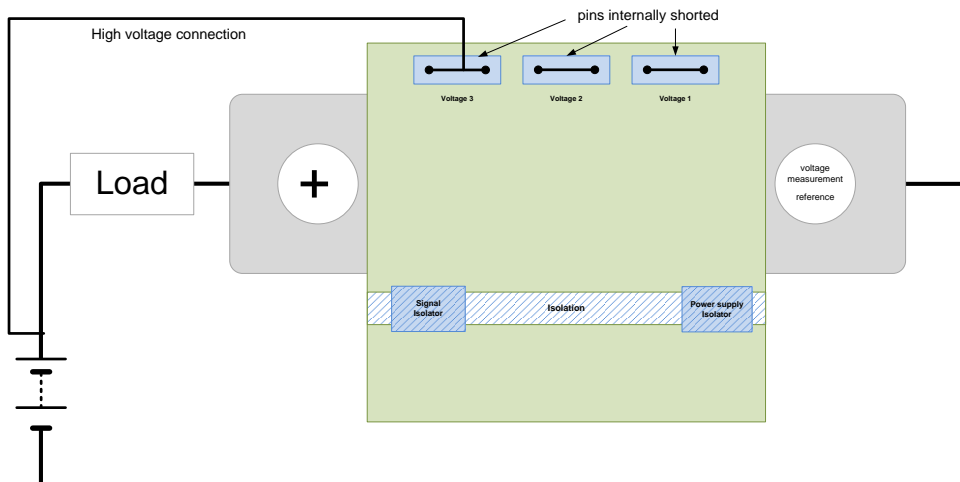

Figure 12: Example for voltage measurement

Note:

The IVT-S can be used for high side measurement (before load), as well as for low side measurement (after load, see Figure 12). Using IVT-S in a high side measurement application it has to be considered to connect the voltage measurement channel in the right direction.



5. Technical Data

5.1. Operation conditions

Parameter	Min	Typical	Max	Unit
Ambient Temperature	-40		+105	°C
Operating Temperature Shunt ¹	-40		+125	°C
Supply Voltage (V _{CC})	5.5	12	40	V
Current Consumption		30	80	mA
Re-/ Startup Time		350	400	ms
Waiting Time Power On/Off	2			ms
Isolation	According to chapter 3.6			

5.2. Maximum ratings

Parameter	Min	Max	Unit
Storage Temperature	-40	+125	°C
Storage Humidity		95	%
Supply Voltage	-42	42	V

Parameter Shunt	Value					Unit
Nominal Measurement Range (depending on shunt)	±100	±300	±500	±1000	±2500	A
Extended Load (max. time)						
5min	±120	±320	±730	±1100	±2700	A
30s	±200	±430	±860	±1400	±3200	A
10s	±300	±600	±1000	±2000	±4300	A
1s	±900	±1600	±2700	±5500	±11300	A
200ms	±2000	±3600	±6000	±12000	±24000	A

5.3. Current measurement

Parameter	Value					Unit
Nominal Measurement Range	±100	±300	±500	±1000	±2500	A
Typical Shunt Resistance	285	95	35	20	5	μΩ
Power Loss	< 3	< 9	< 9	< 20	< 32	W
Overcurrent Measurement Range	±800	±2500	±6900	±12200	±48000	A
Initial Accuracy ²	±0.1					%rdg ³
Total Accuracy ²	±0.4					%rdg ³
Offset	8	25	75	125	500	mA
Linearity	0.01					% of range
Noise	5	15	40	70	280	mA (RMS)
Resolution	3	10	27	47	186	mA
Accuracy Overcurrent Range	± 3					%rdg
Offset Overcurrent Range	60	200	540	940	3720	mA
Linearity Overcurrent Range	0.1					% of range
Noise Overcurrent Range	40	120	320	560	2240	mA (RMS)
Resolution Overcurrent Range	24	80	216	376	1488	mA

¹ Results from 105°C ambient temperature + 20°C self-heating at hotspot (resistance material)

² In nominal measurement range

³ Failure of reading

5.4. Voltage measurement

Parameter	Value	Unit
Nominal Measurement Range	±1000	V
Extended Range (nonlinear)	±1200	V
Typical Input Resistance	4	MΩ
Initial Accuracy	0.1	% of reading
Total Accuracy	0.5	% of reading
Offset	100	mV
Linearity	0.01	% of range
Noise ⁴	60	mV (RMS)
Resolution	30	mV

5.5. Communication

Interface	Specification	Speed	Termination	Max Number of Unit
CAN	2.0 a	250 kbit/s; 500 kbits/s; 1 Mbit/s	120 Ω	6

	Direction		Min	Max	Unit
V _{IH}	High-Level Input Voltage	TXD,S	2	5.25	V
V _{IL}	Low-Level Input Voltage	TXD,S	0	0.8	V
V _{ID}	Differential Input Voltage		-6	6	V
I _{OH}	High-Level Output Current	Driver	-70		mA
		Receiver	2		
I _{OL}	Low-Level Output Current	Driver	70		mA
		Receiver	2		

⁴ Without averaging

6. Mechanical data

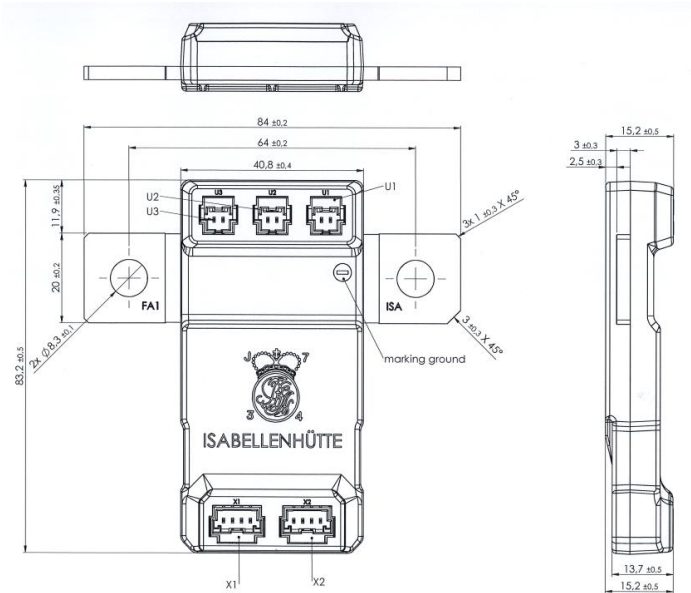

Figure 13: IVT-S 100A, 300A, 500A version

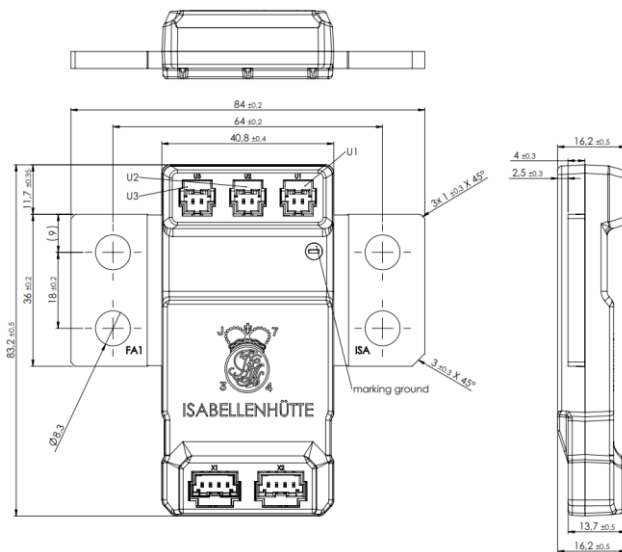

Figure 14: IVT-S 1000A and 2500A version

Variation [A]	Weight [g]
100-500	approx. 71
1000-2500	approx. 133



Note:

Based on the connector configuration the weight can fluctuate around 3 g.

6.1. Busbar connection

The accuracy and repeatability of current measurement depends from the quality of the connection between customer's bus bar and the shunt bus bar.

To ensure a good and useful connection between customer's bus bar and the shunt consider the following instructions:

- Mounting the IVT-S on a bus bar is highly recommended (instead of mounting a cable onto the shunt)
- Screwing the IVT-S on a bus bar by using all mounting holes, never use less than the available hole for screwing
- Always use screws with an outer diameter of 8 mm (M8), using smaller screws (e. g. M6 or M5) is NOT recommended
- Never use flat washers between the bus bar and the shunt!
- All screws using for mounting must be tightened with a torque as equal as possible!
- The recommended torque is **15 – 20 Nm**
- Shunt and bus bar must be clean and free of grease. Cleaning before mounting might be necessary

Mounting recommendation:

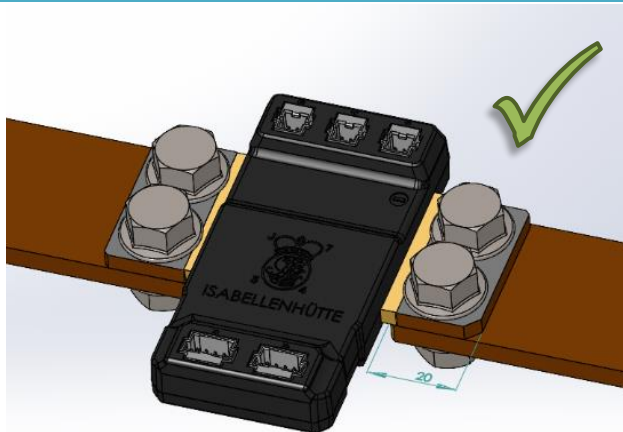

Figure 15: Correct mounting 20mm overlap

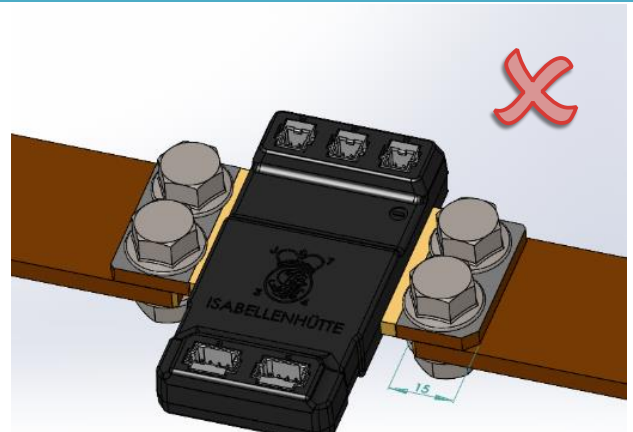

Figure 16: Incorrect mounting 15mm overlap

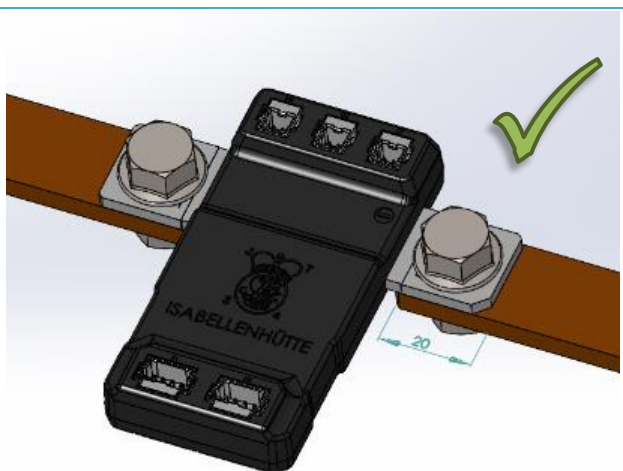

Figure 17: Correct mounting 20mm overlap

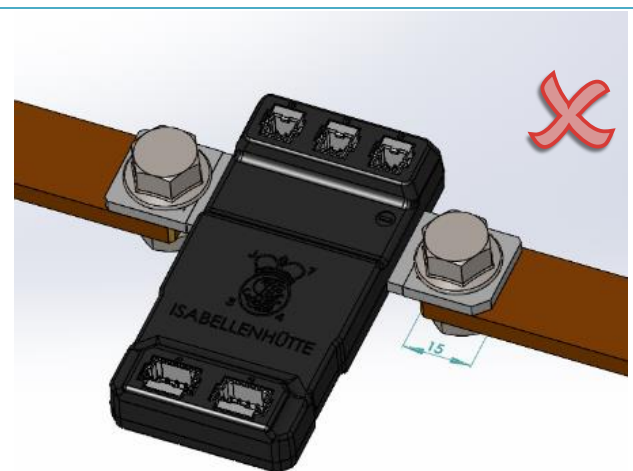

Figure 18: Incorrect mounting 15mm overlap



Note:

- As the Shunt is plated with a NiP surface, it is recommended to use a tin plating for the busbar surface to ensure good thermal conductivity.
- The thermal situation within the application has to be considered to guarantee durability and reliability during the lifetime of the sensor.



Note:

- We strongly recommend not to mount any additional component directly to the sensor.

6.2. Pin configuration / Power Supply and CANbus

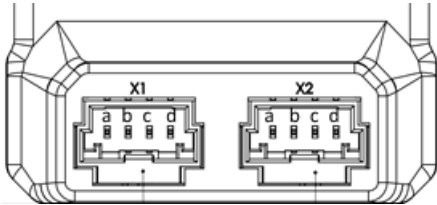

Figure 19: Pin configuration CANbus and power supply

Connector	Function	Pin	Description	Mating Plug
X1 and X2*	Power IN CANbus	a	Vcc	PIN 4
		b	CAN L	PIN 3
		c	CAN H	PIN 2
		d	GND	PIN 1



Note:

- There is no short circuit protection of the GND Line. In case of wrong wiring the sensor can possibly be destroyed!
- X2 a duplicate from X1. Only use for connect through a second sensor

6.3. Pin configuration / Voltage measurement

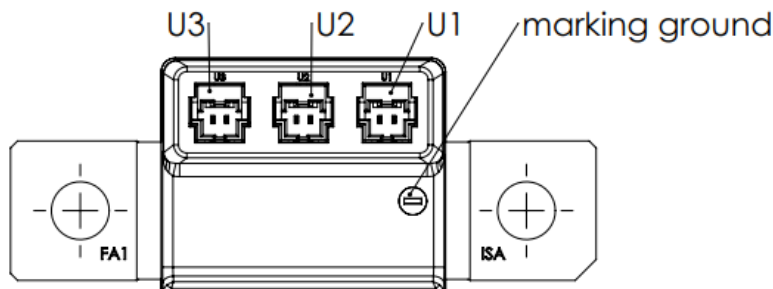

Figure 20: Voltage measurement

Connector	Function	Pin	Description
U1	Voltage Measurement 1	Both	U1 module (Both pins internally shorted)
U2	Voltage Measurement 2	Both	U2 module (Both pins internally shorted)
U3	Voltage Measurement 3	Both	U3 module (Both pins internally shorted)



Note: The high voltage pin reference to module ground

6.4. Module Connector

	Manufacturer	Type	No. of Pins	Man. Part No.
Module Connector	Molex	DuraClik;2mm;vertikal	4	5600200420
Module Connector	Molex	DuraClik;2mm;vertikal	2	5600200220

6.5. Mating plug

Manufacturer	Type	No. of Pins		Man. Part No.
Molex	DuraClik ISL Wire-to-Board; 4 pol.; 2mm; single row	White	-40 - 125°C; autom.	5601230400
Molex	DuraClik ISI Retainer, 4 pol	Gray	-40 - 125°C; autom.	5601250400
Molex	DuraClik ISL Wire-to-Board; 2 pol.; 2mm; single row	White	-40 - 125°C; autom.	5601230200
Molex	DuraClik ISI Retainer, 2 pol	Gray	-40 - 125°C; autom.	5601250200
Molex	Terminal ISL; 0.35mm ²	Tin		5601240101



Note:

The mating plug from the original manufacturer is recommendation based on a standard automotive application. The original manufacturer has different type of this plug. Please check your requirement before the ordering.

7. Part description / Ordering

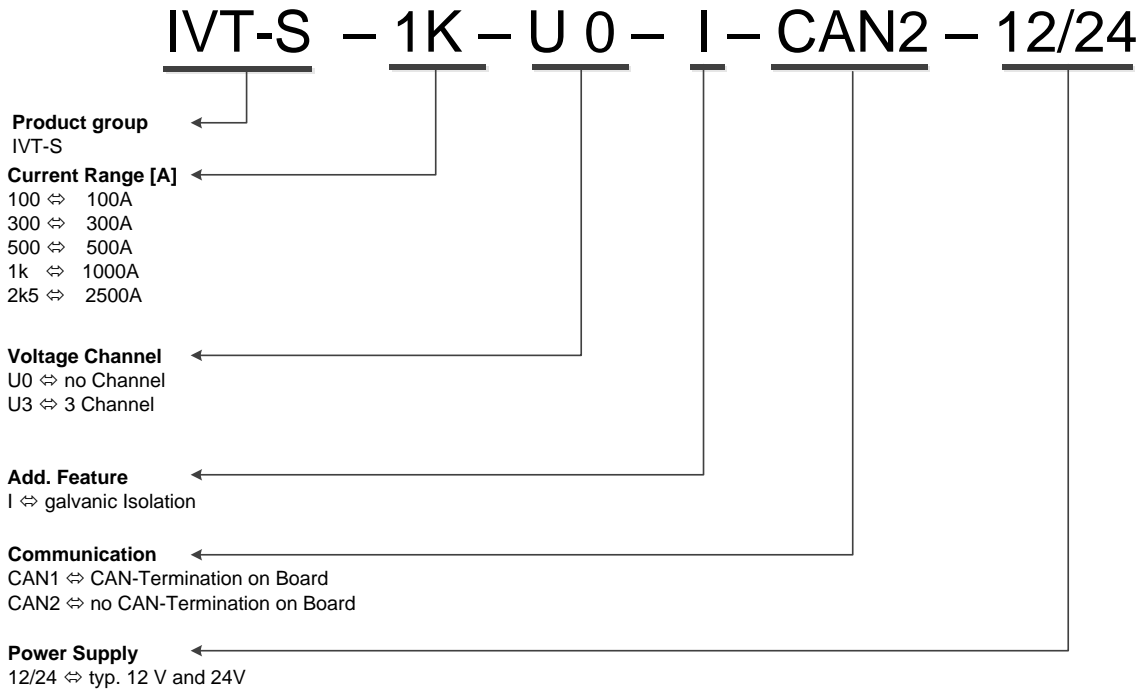
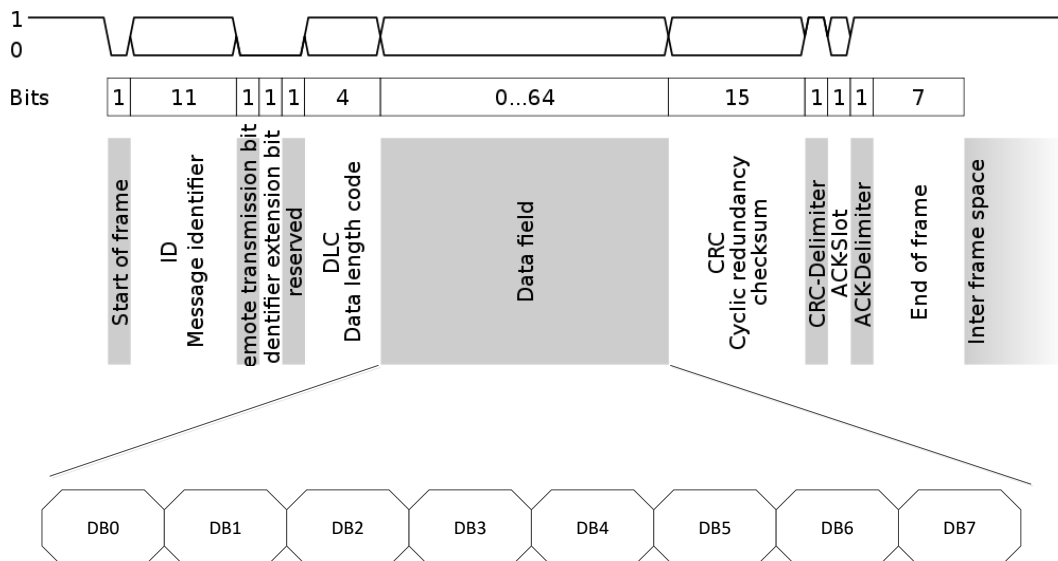

Figure 21: Ordering code and part description

List of IVT-S Variations:
IVT-S-100-U0-I-CAN1-12/24
IVT-S-100-U0-I-CAN2-12/24
IVT-S-100-U3-I-CAN1-12/24
IVT-S-100-U3-I-CAN2-12/24
IVT-S-300-U0-I-CAN1-12/24
IVT-S-300-U0-I-CAN2-12/24
IVT-S-300-U3-I-CAN1-12/24
IVT-S-300-U3-I-CAN2-12/24
IVT-S-500-U0-I-CAN1-12/24
IVT-S-500-U0-I-CAN2-12/24
IVT-S-500-U3-I-CAN1-12/24
IVT-S-500-U3-I-CAN2-12/24
IVT-S-1K-U0-I-CAN1-12/24
IVT-S-1K-U0-I-CAN2-12/24
IVT-S-1K-U3-I-CAN1-12/24
IVT-S-1K-U3-I-CAN2-12/24
IVT-S-2K5-U0-I-CAN1-12/24
IVT-S-2K5-U0-I-CAN2-12/24
IVT-S-2K5-U3-I-CAN1-12/24
IVT-S-2K5-U3-I-CAN2-12/24

8. CANbus protocol



Selectable bitrate

- 1.000.000 bit/s
- 500.000 bit/s (Default)
- 250.000 bit/s

Multiplexable Messages

All Messages sent by the IVT shall be unique identifiable by the first databyte sent as muxbyte.

DB0 (Muxbyte)	Remark
0x0n	Results (measured or calculated)
0x1n	Set CAN ID
0x2n	Set config result
0x3n	Set commands
0x4n	Get error/log data
0x5n	Get CAN ID
0x6n	Get config result
0x7n	Get commands
0x8n	Response on error/log data
0x9n	Responses on CAN ID
0xA n	Responses on Config Result
0xB n	Responses on Set and Get Commands
0xC n	--
0xD n	--
0xE n	--
0xF0 :::0xFE	--
0xFF	Response on not allowed message (also send on request CAN ID 0x00)

8.1. Default parameters

Output and measurement configuration details:

DB0 (n)	Signals	Default MODE	Default TIME [ms]	Min TIME [ms]	Description
0	Current	Cyclic	20	1	output-cycle-time = Measurement-interval
1	U1	Cyclic	60	3	output-cycle-time = Measurement-interval (depending on configuration of U1 .. U3)
2	U2	Cyclic	60	3	output-cycle-time = Measurement-interval (depending on configuration of U1 .. U3)
3	U3	Cyclic	60	3	output-cycle-time = Measurement-interval (depending on configuration of U1 .. U3)
4	T	Disable	100	1	Output-cycle-time, Measurement-interval = 100 ms
5	P in W _{U1}	Disable	30	1	Output-cycle-time, Measurement-interval = 30 ms
6	Q in As	Disable	30	1	Output-cycle-time, Measurement-interval = 30 ms
7	ΔE in Wh _{U1}	Disable	30	1	Output-cycle-time, Measurement-interval = 30 ms

- Min Time for three configured voltage result messages
- The configuration has to ensure that the maximum output rate of all messages shall not exceed 1000 messages per second. Otherwise the data calculation for As, Wh and Log data can be influenced.

Signals	Mode	Value
CAN bitrate	-	500.000 bit/s
OC Threshold (+)	Off	(1 ... 32767 A)
OC Threshold (-)	Off	(-32768 ... -1 A)
OC Reset Threshold (+)	Off	(1 ... 32767 A)
OC Reset Threshold (-)	Off	(-32768 ... -1 A)

Messages Overview

Description	Default CAN-ID	Default Endian	Length DLC	Remark
IVT_Msg_Command	0x411	Big Endian	8	Function commands, SET and GET commands A command-ID-byte is included for identification
IVT_Msg_Debug	0x510	-	8	Message only for internal use
IVT_Msg_Response	0x511	Big Endian	8	Response to SET and GET command messages A response-ID-byte is included for identification
IVT_Msg_Result_I	0x521	Big Endian	6	Current
IVT_Msg_Result_U1	0x522	Big Endian	6	Voltage 1
IVT_Msg_Result_U2	0x523	Big Endian	6	Voltage 2
IVT_Msg_Result_U3	0x524	Big Endian	6	Voltage 3
IVT_Msg_Result_T	0x525	Big Endian	6	Temperature
IVT_Msg_Result_W	0x526	Big Endian	6	Power (referring to current and voltage U1)
IVT_Msg_Result_As	0x527	Big Endian	6	Current counter
IVT_Msg_Result_Wh	0x528	Big Endian	6	Energy counter (referring to current and voltage U1)

- Not used bytes in response messages are undefined and reported as 0x00.
- Not used / undefined bytes in command messages must be set to 0x00.
- Each defined command will report its response message even if there was no change done or is currently not allowed (e.g. set configuration during run mode). This is done to give acknowledge to the sender.
- Consecutive commands must be sent not faster than 2 ms, or you can wait until the related response is sent.
- Response messages must be available on the bus (free bus) at least +500 ms after the related command, if not otherwise specified.

8.2. Result messages

DB	Signal	Value	Description
0	MuxID	0x00 .. 0x07	multiplexer, n = channel number
1 Low nibble	IVT_MsgCount	0x0 .. 0xF	Cyclic counter individually for each channel
1 High nibble	IVT_Result_state	0b0000 .. 0b1111	bit 0: set if OCS is true bit 1: set if - this result is out of (spec-) range, - this result has reduced precision - this result has a measurement-error bit 2: set if - any result has a measurement-error bit 3: set if - any result has a system-error → sensor functionality is not ensured!
2 .. 5	IVT_<Resultname>		All Results as signed long, see configuration

- Independent of the measurement and system error bit masks (s. chapter 8.4. and 8.6.), bit 2 and 3 can always occur due to CRC errors. Bit 2 also in case of Vref errors.

MuxID description for IVT_Msg_Result

MuxID	Result	Unit
0x00	IVT_Msg_Result_I	1 mA
0x01	IVT_Msg_Result_U1	1 mV
0x02	IVT_Msg_Result_U2	1 mV
0x03	IVT_Msg_Result_U3	1 mV
0x04	IVT_Msg_Result_T	0,1 °C
0x05	IVT_Msg_Result_W	1 W
0x06	IVT_Msg_Result_As	1 As
0x07	IVT_Msg_Result_Wh	1 Wh

Examples:

Default configured as "big Endian" (see Config Result)

Example for Results: Message					
DB 0	DB1	DB 2	DB 3	DB 4	DB 5
0x01	0x05	0x00	0x00	0x88	0xb8

Decode the Message: Byte(s)	Value	Information
DB 0	0x01	IVT_Msg_Result_U1
DB 1 – High-byte	0x0	state bits = 0
DB 1 – Low-byte	0x5	Message number 5
DB 2 to DB 5	0x000088b8	35.000 mV

Optionally configured as "little Endian" (see Config Result)

Example for Results: Message					
DB 0	DB1	DB 2	DB 3	DB 4	DB 5
0x01	0x05	0xb8	0x88	0x00	0x00

Decode the Message: Byte(s)	Value	Information
DB 0	0x01	IVT_Msg_Result_U1
DB 1 – High-byte	0x0	state bits = 0
DB 1 – Low-byte	0x5	Message number 5
DB 2 to DB 5	0xb8880000	35.000 mV

8.3. Set CAN ID

Command "Set CAN ID"

DB	Value	Remark
0	0x10 0x11 0x12 0x13 0x14 0x15 0x16 0x17 0x1D 0x1F	Indicates which message type is being changed: IVT_Msg_Result_I IVT_Msg_Result_U1 IVT_Msg_Result_U2 IVT_Msg_Result_U3 IVT_Msg_Result_T IVT_Msg_Result_W IVT_Msg_Result_As IVT_Msg_Result_Wh IVT_Msg_Command IVT_Msg_Response
1	0 ... 0x07	High byte of desired 11 bit CAN ID
2	0 ... 0xFF	Low byte of desired 11 bit CAN ID
3	0x00 ... 0xFF	High byte of 32-bit-serial number
4	0x00 ... 0xFF	Mid-high byte of 32-bit-serial number
5	0x00 ... 0xFF	Mid-low-byte of 32-bit-serial number
6	0x00 ... 0xFF	Low byte of 32-bit-serial number

- Configuration only in Stop-Mode

8.4. Config Result

Set Config Result

DB	Value	Remark
0	0x2n	Set configuration of measurement "n" represents the according result (e.g. 3 = IVT_Msg_Result_U3)
1 Low nibble	0x0 0x1 0x2	Trigger mode: disabled triggered cyclic running
1 High nibble	0bnnn1 0bnn1n 0bn1nn 0b1nnn	Config Result Flags in high byte Bit 4: for future use Bit 5: 0: Measurement and System error bit masks are not reported in IVT_Result_state bits 2 and 3 (default) 1: Measurement and System error bit masks are reported in IVT_Result_state bits 2 and 3 Bit 6: endianness, 0: Big Endian (default) , 1: Little Endian Bit 7: sign unchanged (default), 1=sign is changed (+ <-> -)
2 - 3	0xnxxx	output-cycle-time / Measurement-interval / Trigger delay [ms] (+/- 10%) 0x0000 is ignored. // Trigger delay begins at 1ms

- Configuration only in Stop-Mode
- Bit 5 can be set in every measurement configuration (0x2n). It is a global setting and enables [1] / disables [0] the error bit mask reporting of all active channels. (In case of several channel configurations the last configuration of Bit 5 decides about the used error bit setting)

8.5. Set-Commands

Command "Reset Error- and Logdata"

DB	Value	Remark
0	0x30	Reset Error- and Logdata
1	0x00 0x01 0x02	Reset "Measurement Error" Reset "System Error" Reset "Logdata Since Reset"
2	0x00 0x01 .. 0xFF	All Counters reset DB1 of corresponding Error or Logdata value to be cleared
3 - 6	0xnntnnnnn	Serial-number

- Command only in Stop-Mode
- Response message at least +1200ms after command

➤ Set-Commands without restart

Command "TRIGGER"

DB	Value	Remark
0	0x31	Trigger a measurement cycle.
1 - 2	0xnntnn	Bit field for Channel to trigger, 0-unselected 1-selected
	0b0000 0000 xxxx xxx1	IVT_Msg_Result_I
	0b0000 0000 xxxx xx1x	IVT_Msg_Result_U1
	0b0000 0000 xxxx x1xx	IVT_Msg_Result_U2
	0b0000 0000 xxxx 1xxx	IVT_Msg_Result_U3
	0b0000 0000 xxx1 xxxx	IVT_Msg_Result_T
	0b0000 0000 xx1x xxxx	IVT_Msg_Result_W
	0b0000 0000 x1xx xxxx	IVT_Msg_Result_As
	0b0000 0000 1xxx xxxx	IVT_Msg_Result_Wh

- Command available only in Run-Mode

Command "STORE"

DB	Value	Remark
0	0x32	All configured items are stored to nonvolatile memory: -Measurement configurations -Overcurrent thresholds -Startup Mode -CAN-ID's -Baud rate

- The storing process is only completed if the related response message is sent by module, up to +1000ms depending on amount of data to store.
- No further commands are allowed if storing is in progress.
- Remark: The storing command is only available during Module is in stop mode

Command "START_OC_TEST"

DB	Value	Remark
0	0x33	Test the OC signal
1+2	0 .. 65535	duration of the OC signal in ms

- Command only in Stop-Mode

Command "SET_MODE"

Mode means the whole sensor (config means the result message).

DB	Value	Remark
0	0x34	Set operation mode
1	0x00 0x01	Actual Mode (valid until next reset) Stop Run
2	0x00 0x01	Startup operation mode (STORE command required before reset) Stop Run
3+4	0x0000 0xnnnn 0xyyyy	Code for level of access for future use user expert (nnnn = access key) for further use only OEM customer (yyyy = access key) for further use only

- retrievable in STOP- and RUN-mode

Command "SET_THRESHOLD_POS"

DB	Value	Remark
0	0x35	Set overcurrent thresholds positive current direction
1 +2	--32768 ... 32767	Overcurrent <u>set threshold</u> in 1A-steps 0 means off (default)
3+4	--32768 ... 32767	Overcurrent <u>reset threshold</u> in 1A-steps 0 means off

- Command only in Stop-Mode

Command "SET_THRESHOLD_NEG"

DB	Value	Remark
0	0x36	Set overcurrent thresholds negative current direction
1+2	--32768 ... 32767	Overcurrent <u>set threshold</u> in 1A-steps 0 means off (default)
3+4	--32768 ... 32767	Overcurrent <u>reset threshold</u> in 1A-steps 0 means off

- Command only in Stop-Mode

➤ **Set-Commands with restart**



Note: Every restart command leads to an Error Reset Watchdog (chapter 8.2. - result messages)

Command "RESTART_to_Bitrate"

DB	Value	Remark
0	0x3A	Restart to configured Bitrate
1	0x08 0x04 0x02	Bitrate acc. to pre-scaler: 250k 500k (default) 1000k

- Bitrate is automatically stored before reboot. This may take additional time (up to 1s) which must be added to the following startup time.
- Command only in Stop-Mode

Command "RESTART_to_default"

DB	Value	Remark
0	0x3D	RESTART_to_default

- Command only in Stop-Mode

Command "RESTART"

DB	Value	Remark
0	0x3F	Restart

- retrievable in STOP- and RUN-mode

8.6. Get Error- and Logdata

3 steps of error detection

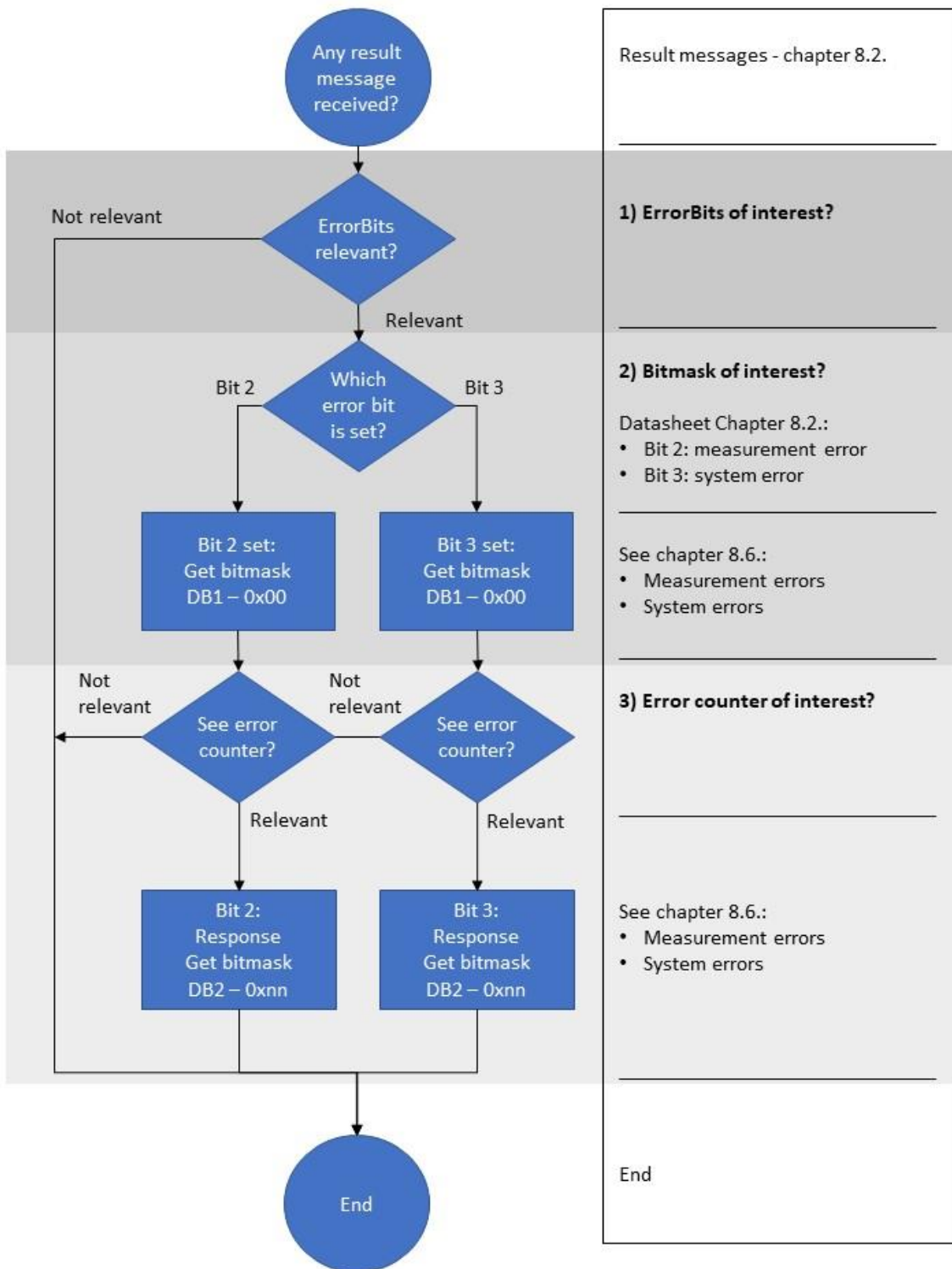

Get measurement errors

DB	Value	Remark	Related to channel	Description
0	0x40	Get measurement errors		
1	0x00	Get bitmask of occurred measurement errors (specific counter != 0)		
		Get specific Error Counter (Positive edge of error state cause up counting):		
	0x01	Error ADC interrupt	all	Interrupt comes while measured values are being read out
	0x02	Error Overflow ADC channel 1	I1	ADC channel 1 out of nominal measurement range, while ADC channel 2 in nominal measurement range
	0x03	Error Underflow ADC channel 1	I1	ADC channel 1 out of nominal measurement range, while ADC channel 2 in nominal measurement range
	0x04	Error Overflow ADC channel 2	I2, U1-U3	ADC channel 2 out of nominal measurement range
	0x05	Error Underflow ADC channel 2	I2, U1-U3	ADC channel 2 out of nominal measurement range
	0x06	Error Vref	all	Plausibility check of all measurements of ADC concerning Vref
	0x07	Error current measurement implausible I1 – I2 (check in nominal range)	I1, I2	Check of Delta Sigma measurement channel of the ADC
	0x08	Error thermal EMF correction	I1	Delta of the two NTCs is > 30K
	0x09	Error current measurement I1 open circuit	I1	Open circuit detection I1
	0x0a	Error voltage measurement U1 open circuit	U1	Open circuit detection U1
	0x0b	Error voltage measurement U2 open circuit	U2	Open circuit detection U2
	0x0c	Error voltage measurement U3 open circuit	U3	Open circuit detection U3
	0x0d	Error ntc-h open circuit	I1,I2,T	Open circuit detection ntc-h
	0x0e	Error ntc-l open circuit	I1,I2,T	Open circuit detection ntc-l
	0x0f	Error calibration data (offset-, gain error to high)	all	Set if calibration data detected as not valid

- retrievable in STOP- and RUN-mode

Get system errors

DB	Value	Remark	Description
0	0x41	Get system errors	
1	0x00	Get bitmask of occurred system errors (specific counter != 0)	
		Get specific Error Counter (Positive edge of error state cause up counting):	
	0x01	Error Code CRC	Verification of application CRC
	0x02	Error Parameter CRC	Verification if the CRC of the calibration parameter can be read
	0x03	Error CAN bus receive Data	Limit of μ C Error Counter reached
	0x04	Error CAN bus transmit Data	Limit of μ C Error Counter reached
	0x05	Error overtemp	Detection of an over temperature ($\geq 105^{\circ}\text{C}$)
	0x06	Error undertemp	Detection of a under temperature ($\leq -40^{\circ}\text{C}$)
	0x07	Error power failure	Verification if the reference voltage of the ADC is in the specified range
	0x08	Error system clock	Verification of the ADC and μ C clock integrity
	0x09	Error system init	Set if previous CAN configuration CRC is failed or previous CAN prescaler configuration could not be loaded
	0x0a	Error configuration	ROP (read out protection) is not set inside the μ C.
	0x0b	Error internal ADC	Internal ADC was "not ready" for 10 times
	0x0c	Error eeprom r/w	Verification if CRC is logged and valid in EEPROM
	0x0d	Error ADC Clock	Checks the frequency drift of internal μ C timer and constant cyclic HW ADC interrupt
	0x0e	Error Reset illegal opcode	Verification of μ C manufacturing data
	0x0f	Error Reset Watchdog	Watchdog reset
0x10	Error Reset EMC	μ C detects reset fault due to EMC noise	

- retrievable in STOP- and RUN-mode

Get Overall Logdata (reset only by Isabellenhütte)

DB	Value	Remark
0	0x42	Get Overall Logdata
1		Get details of Logdata:
	0x01	Ampere hour counter overall (As)
	0x02	Ampere hour counter charging (As)
	0x03	Ampere hour counter discharging (As)
	0x04	Energy counter overall (Wh)
	0x05	Energy counter charging (Wh)
	0x06	Energy counter discharging (Wh)
	0x10	Runtime overall (s)
	0x11	Runtime current within specified limits (s)
	0x12	Runtime current outside specified limits (s)
	0x13	Runtime voltage 1 within specified limits (s)
	0x14	Runtime voltage 1 outside specified limits (s)
	0x15	Runtime voltage 2 within specified limits (s)
	0x16	Runtime voltage 2 outside specified limits (s)
	0x17	Runtime voltage 3 within specified limits (s)
	0x18	Runtime voltage 3 outside specified limits (s)
	0x19	Runtime temperature within specified limits (s)
	0x1A	Runtime temperature outside specified limits (s)
	0x1B	Runtime overcurrent positive activated (s)
	0x1C	Runtime overcurrent negative activated (s)
	0x21	Current maximum (A)
	0x22	Current minimum (A)
	0x23	U1 maximum (V)
	0x24	U1 minimum (V)
	0x25	U2 maximum (V)
	0x26	U2 minimum (V)
	0x27	U3 maximum (V)
	0x28	U3 minimum (V)
	0x29	Temperature maximum (°C)
	0x2A	Temperature minimum (°C)

- retrievable in STOP- and RUN-mode

Get Logdata Since Reset (Reset by using command)

DB	Value	Remark
0	0x43	Get Logdata Since Reset
1		Get details of Logdata:
	0x01	Ampere hour counter overall (As)
	0x02	Ampere hour counter charging (As)
	0x03	Ampere hour counter discharging (As)
	0x04	Energy counter overall (Wh)
	0x05	Energy counter charging (Wh)
	0x06	Energy counter discharging (Wh)
	0x10	Runtime overall (s)
	0x11	Runtime current within specified limits (s)
	0x12	Runtime current outside specified limits (s)
	0x13	Runtime voltage 1 within specified limits (s)
	0x14	Runtime voltage 1 outside specified limits (s)
	0x15	Runtime voltage 2 within specified limits (s)
	0x16	Runtime voltage 2 outside specified limits (s)
	0x17	Runtime voltage 3 within specified limits (s)
	0x18	Runtime voltage 3 outside specified limits (s)
	0x19	Runtime temperature within specified limits (s)
	0x1A	Runtime temperature outside specified limits (s)
	0x1B	Runtime overcurrent positive activated (s)
	0x1C	Runtime overcurrent negative activated (s)
	0x21	Current maximum (A)
	0x22	Current minimum (A)
	0x23	U1 maximum (V)
	0x24	U1 minimum (V)
	0x25	U2 maximum (V)
	0x26	U2 minimum (V)
	0x27	U3 maximum (V)
	0x28	U3 minimum (V)
	0x29	Temperature maximum (°C)
	0x2A	Temperature minimum (°C)

- retrievable in STOP- and RUN-mode

Get CAN ID

DB	Value	Remark
0	0x50 0x51 0x52 0x53 0x54 0x55 0x56 0x57 0x5D 0x5F	Indicates which message type is requested: IVT_Msg_Result_I IVT_Msg_Result_U1 IVT_Msg_Result_U2 IVT_Msg_Result_U3 IVT_Msg_Result_T IVT_Msg_Result_W IVT_Msg_Result_As IVT_Msg_Result_Wh IVT_Msg_Command IVT_Msg_Response
1	0 ... 0x00	Ignored
2	0 ... 0x00	Ignored
3	0x00 ... 0xFF	High byte of 32-bit-serial number
4	0x00 ... 0xFF	Mid-high byte of 32-bit-serial number
5	0x00 ... 0xFF	Mid-low-byte of 32-bit-serial number
6	0x00 ... 0xFF	Low byte of 32-bit-serial number

- retrievable in STOP- and RUN-mode

Get Config Result

DB	Value	Remark
0	0x60 0x61 0x62 0x63 0x64 0x65 0x66 0x67	Get Config Result_I Result_U1 Result_U2 Result_U3 Result_T Result_W Result_As Result_Wh

- retrievable in STOP- and RUN-mode

Get commands and Info's without corresponding set-commands

DB	Value	Command	Remark
0	0x73	GET_OC_TESTTIME	Get the remaining OC_TESTTIME
0	0x74	GET_MODE	Get the operation mode setting
0	0x75	GET_THRESHOLD_POS	Get the configuration of overcurrent thresholds Pos
0	0x76	GET_THRESHOLD_NEG	Get the configuration of overcurrent thresholds Neg
0	0x79	GET_DEVICE_ID	Get the device ID
0	0x7A	GET_SW_VERSION	Get the software version
0	0x7B	GET_SERIAL_NUMBER	Get the serial number

DB	Value	Command	Remark
0	0x7C	GET_ARTICLE_NUMBER	Get the article number

- retrievable in STOP- and RUN-mode

Responses on Error- and Logdata

DB	Value	Remark
0	0x80	Response measurement errors
1	0x00	Response bitmask of occurred measurement errors (specific counter != 0)
2		Bits 0 .. 7 of measurement errors
	0b00000001	Error ADC interrupt
	0b00000010	Error Overflow ADC channel 1
	0b00000100	Error Underflow ADC channel 1
	0b00001000	Error Overflow ADC channel 2
	0b00010000	Error Underflow ADC channel 2
	0b00100000	Error Vref
	0b01000000	Error current measurement implausible I1 – I2
	0b10000000	Error thermal EMF correction
3		Bits 0 .. 7 of measurement errors
	0b00000001	Error current measurement I1 open circuit
	0b00000010	Error voltage measurement U1 open circuit
	0b00000100	Error voltage measurement U2 open circuit
	0b00001000	Error voltage measurement U3 open circuit
	0b00010000	Error ntc-h open circuit
	0b00100000	Error ntc-l open circuit
	0b01000000	Error calibration data (offset-, gain error to high)

- retrievable in STOP- and RUN-mode, depends on get command DB1

DB	Value	Remark
0	0x80	Response measurement errors
1		Specific Error Counter
	0x01	Error ADC interrupt
	0x02	Error Overflow ADC channel 1
	0x03	Error Underflow ADC channel 1
	0x04	Error Overflow ADC channel 2
	0x05	Error Underflow ADC channel 2
	0x06	Error Vref
	0x07	Error current measurement implausible I1 – I2
	0x08	Error thermal EMF correction
	0x09	Error current measurement I1 open circuit
	0x0a	Error voltage measurement U1 open circuit
	0x0b	Error voltage measurement U2 open circuit
	0x0c	Error voltage measurement U3 open circuit
0x0d	Error ntc-h open circuit	

DB	Value	Remark
	0x0e	Error ntc-l open circuit
	0x0f	Error calibration data (offset-, gain error to high)
2	0xnn	Number of occurred errors (max. 256)

- retrievable in STOP- and RUN-mode, depends on get command DB1

Response on system errors

DB	Value	Remark
0	0x81	Response system errors
1	0x00	Response bitmask of occurred system errors (specific counter != 0)
2	0b00000001 0b00000010 0b00000100 0b00001000 0b00010000 0b00100000 0b01000000 0b10000000	Bits 0 .. 7 of measurement errors Error Code CRC Error Parameter CRC Error CAN bus receive Data Error CAN bus transmit Data Error overtemp Error undertemp Error power failure Error system clock
3	0b00000001 0b00000010 0b00000100 0b00001000 0b00010000 0b00100000 0b01000000 0b10000000	Bits 0 .. 7 of measurement errors Error system init Error configuration Error overcurrent detection Error eeprom r/w Error ADC Clock Error Reset illegal opcode Error Reset Watchdog Error Reset EMC

- retrievable in STOP- and RUN-mode, depends on get command DB1

DB	Value	Remark
0	0x81	Response system errors
1	0x01 0x02 0x03 0x04 0x05 0x06 0x07 0x08 0x09 0x0a 0x0b 0x0c 0x0d 0x0e 0x0f 0x10	Specific Error Counter Error Code CRC Error Parameter CRC Error CAN bus receive Data Error CAN bus transmit Data Error overtemp Error undertemp Error power failure Error system clock Error system init Error configuration Error overcurrent detection Error eeprom r/w Error ADC Clock Error Reset illegal opcode Error Reset Watchdog Error Reset EMC
2	0xnn	Number of occurred errors (max. 256)

- retrievable in STOP- and RUN-mode, depends on get command DB1

Response on Overall Logdata

DB	Value	Remark
0	0x82	Response on Overall Logdata
1	0x01 0x02 0x03 0x04 0x05 0x06 0x10 0x11 0x12 0x13 0x14 0x15 0x16 0x17 0x18 0x19 0x1A 0x1B 0x1C 0x21 0x22 0x23 0x24 0x25 0x26 0x27 0x28 0x29 0x2A	Details of Logdata Ampere hour counter overall (As) Ampere hour counter charging (As) Ampere hour counter discharging (As) Energy counter overall (Wh) Energy counter charging (Wh) Energy counter discharging (Wh) Runtime overall (s) Runtime current within specified limits (s) Runtime current outside specified limits (s) Runtime voltage 1 within specified limits (s) Runtime voltage 1 outside specified limits (s) Runtime voltage 2 within specified limits (s) Runtime voltage 2 outside specified limits (s) Runtime voltage 3 within specified limits (s) Runtime voltage 3 outside specified limits (s) Runtime temperature within specified limits (s) Runtime temperature outside specified limits (s) Runtime oc positive activated (s) Runtime oc negative activated (s) Current maximum (A) Current minimum (A) U1 maximum (V) U1 minimum (V) U2 maximum (V) U2 minimum (V) U3 maximum (V) U3 minimum (V) Temperature maximum (°C) Temperature minimum (°C)
2	0x00..0xFF	Highest byte of Logdata value (see signal definition)
3	0x00..0xFF	..
4	0x00..0xFF	..
5	0x00..0xFF	..
6	0x00..0xFF	..
7	0x00..0xFF	Lowest byte of Logdata value (see signal definition)

Response on Logdata Since Reset

DB	Value	Remark
0	0x83	Response on Logdata Since Reset
1	0x01 0x02 0x03 0x04 0x05 0x06 0x10 0x11 0x12 0x13 0x14 0x15 0x16 0x17 0x18 0x19 0x1A 0x1B 0x1C 0x21 0x22 0x23 0x24 0x25 0x26 0x27 0x28 0x29 0x2A	Details of Logdata Ampere hour counter overall (As) Ampere hour counter charging (As) Ampere hour counter discharging (As) Energy counter overall (Wh) Energy counter charging (Wh) Energy counter discharging (Wh) Runtime overall (s) Runtime current within specified limits (s) Runtime current outside specified limits (s) Runtime voltage 1 within specified limits (s) Runtime voltage 1 outside specified limits (s) Runtime voltage 2 within specified limits (s) Runtime voltage 2 outside specified limits (s) Runtime voltage 3 within specified limits (s) Runtime voltage 3 outside specified limits (s) Runtime temperature within specified limits (s) Runtime temperature outside specified limits (s) Runtime oc positive activated (s) Runtime oc negative activated (s) Current maximum (A) Current minimum (A) U1 maximum (V) U1 minimum (V) U2 maximum (V) U2 minimum (V) U3 maximum (V) U3 minimum (V) Temperature maximum (°C) Temperature minimum (°C)
2	0x00..0xFF	Highest byte of Logdata value (see signal definition)
3	0x00..0xFF	..
4	0x00..0xFF	..
5	0x00..0xFF	..
6	0x00..0xFF	..
7	0x00..0xFF	Lowest byte of Logdata value (see signal definition)

Response "CAN_ID"

DB	Value	Remark
0	0x90 0x91 0x92 0x93 0x94 0x95 0x96 0x97 0x9D 0x9F	Indicates which message type is being changed: IVT_Msg_Result_I IVT_Msg_Result_U1 IVT_Msg_Result_U2 IVT_Msg_Result_U3 IVT_Msg_Result_T IVT_Msg_Result_W IVT_Msg_Result_As IVT_Msg_Result_Wh IVT_Msg_Command IVT_Msg_Response
1	0 ... 0x07	High byte of desired 11 bit CAN ID
2	0 ... 0xFF	Low byte of desired 11 bit CAN ID
3	0x00 ... 0xFF	High byte of 32-bit-serial number
4	0x00 ... 0xFF	Mid-high byte of 32-bit-serial number
5	0x00 ... 0xFF	Mid-low-byte of 32-bit-serial number
6	0x00 ... 0xFF	Low byte of 32-bit-serial number

Response "CONFIG Result"

DB	Value	Remark
0	0xAn	Response configuration of measurement n represents the According result (e.g. 3 = IVT_Msg_Result_U3)
1 LOW byte	0x0 0x1 0x2	Trigger mode: disabled triggered cyclic running
1 HIGH byte	0bnnn1 0bnn1n 0bn1nn 0b1nnn	Config Result Bit 4: for future use Bit 5: 0: Measurement and System error bit masks are not reported in IVT_Result_state bits 2 and 3 (default) 1: Measurement and System error bit masks are reported in IVT_Result_state bits 2 and 3 Bit 6: endianness, 0: Big Endian (default) , 1: Little Endian Bit 7: sign of result, 0: default, 1: sign is changed (+ <-> -), changes polarity (+ <-> -)
2 - 3	0xnxxx	output-cycle-time / Measurement-interval / Trigger delay [ms] (+/- 10%)

Response on Get and Set commands

Response messages are sent by the sensor as a response to a SET or GET command message. The response to a SET command works just like the response to a GET command.

Response "Reset Error- and Logdata"

DB	Value	Remark
0	0xB0	Response Logdata
1	0x00 0x01 0x02	Reset "Measurement Error" Reset "System Error" Reset "Logdata Since Reset"
2	0x00 0x01 .. 0xFF	All Counters reset DB1 of corresponding Error or Logdata value to be cleared
3 - 6	0xn n n n n n n n	Serial-number

Response "TRIGGER"

DB	Value	Remark
0	0xB1	Response Trigger
1 - 2	0b0000 0000 n n n n n n n n	Bit field for Channel to trigger, 0-unselected 1-selected, all other bits are undefined and must be set to 0

Response "STORE"

DB	Value	Remark
0	0xB2	Response STORE (Response after successful writing to non-volatile memory)
1	0xnn	0 = OK, Error else
2	0x00 ... 0xFF	High byte of 32-bit-serial number
3	0x00 ... 0xFF	Mid-high-byte of 32-bit-serial number
4	0x00 ... 0xFF	Mid-low byte of 32-bit-serial number
5	0x00 ... 0xFF	Low byte of 32-bit-serial number

Response "OC_TEST"

DB	Value	Remark
0	0xB3	Response OC-Test
1 + 2	0 .. 65535	remaining OC-Test time (ms)

Response "MODE"

Mode means the whole sensor (config means the result message).

DB	Value	Remark
0	0xB4	Response operation mode
1	0x00 0x01	STOP RUN
2	0x00 0x01	Startup operation mode Stop Run
3+4	0x0000 0xn n n n 0xy y y y	Code for level of access for future use user expert (n n n n = access key) OEM customer (y y y y = access key)

Response "THRESHOLD_POS"

DB	Value	Remark
0	0xB5	Response overcurrent thresholds positive current direction
1 +2	-32767 ... 32767	Overcurrent set threshold in 1A-steps, 0 means off
3+4	-32767 ... 32767	Overcurrent reset threshold in 1A-steps, 0 means off

Response "THRESHOLD_NEG"

DB	Value	Remark
0	0xB6	Response overcurrent thresholds negative current direction
1 +2	-32767 ... 32767	Overcurrent set threshold in 1A-steps, 0 means off
3+4	-32767 ... 32767	Overcurrent reset threshold in 1A-steps, 0 means off

Response "DEVICE_ID"

DB	Value	Remark
0	0xB9	Response DEVICE_ID
1	0x02	Device-type 2 = IVT-S
2	0x06 0x12 0x1F 0x3E 0x9C	I-nominal / 16 100 A 300 A 500 A 1000 A 2500 A
3 high nibble	0x4 0xC 0x4 0x8 0x4	I-nominal % 16 100 A 300 A 500 A 1000 A 2500 A
3 low nibble	0x0 0x3	Number of Voltage Channels 0 Channels 3 Channels
4	0x03	Trigger (T) / OCS(O) / Isolation(I) / -(none) I
5	0x00 0x01 0x02	Type of communication (none) CAN1 (termination) CAN2 (no termination)
6	0x01	12/24 nominal supply voltage [V]

Response "SW_VERSION"

DB	Value	Remark
0	0xBA	Response SW_VERSION
1	0xn000 0000 .. 0xn111 1111	VERSION_NR_MAJOR 0: illegal version

DB	Value	Remark
	0b1nnn nnnn	1 ... 127: Major Version Bit mask: Represents a debug version if set
2	0x00 ... 0xFF	VERSION_NR_MINOR 0 ... 255
3	0x00 ... 0xFF	VERSION_REV 0 ... 255
4	0x00 ... 0xFF	VERSION_YY Year
5	0x00 ... 0xFF	VERSION_MM Month
6	0x00 ... 0xFF	VERSION_DD Day
7	0x00 ... 0xFF	Internal use

Response "SERIAL NUMBER"

DB	Value	Remark
0	0xBB	Response serial number
1	0x00 ... 0xFF	High byte serial number
2	0x00 ... 0xFF	Mid high byte serial number
3	0x00 ... 0xFF	Mid low byte serial number
4	0x00 ... 0xFF	Low byte serial number

Response "ARTICLE_NUMBER"

DB	Value	Remark
0	0xBC	Response article number
1	0x00 ... 0xFF	High byte article number
2	0x00 ... 0xFF	..
3	0x00 ... 0xFF	..
4	0x00 ... 0xFF	..
5	0x00 ... 0xFF	..
6	0x00 ... 0xFF	..
7	0x00 ... 0xFF	Low byte article number

Error message

DB	Value	Remark
0	0xFF	Not allowed command, or not otherwise specified (also send on request CAN ID 0x00)
1	0x00 ... FF	MUX ID of invalid command

9. Startup

During Startup, the Sensor performs several internal tests to ensure the system functionality.

These are:

- CPU Register check
- RAM test
- CPU clock test
- Boot-loader Flash test CRC
- App-Flash test CRC
- Calibration Parameter test CRC
- User parameter test CRC

Start-up behaviour (Alive message)

DB	Value	Remark
0	0xBF	Alive message after start-up (sensor ready for communication)
1	0x00 ... 0x07	Command ID (High Byte)
2	0x00 ... 0xFF	Command ID (Low Byte)
3	0x00 ... 0xFF	High byte serial number
4	0x00 ... 0xFF	Mid high byte serial number
5	0x00 ... 0xFF	Mid low byte serial number
6	0x00 ... 0xFF	Low byte serial number

10. Qualification

Standard	Description
ISO 16750-2:2010	Direct current supply voltage
ISO 16750-2:2010	Overvoltage
ISO 16750-2:2010	Superimposed alternating voltage
ISO 16750-2:2010	Slow decrease and increase of supply voltage
ISO 16750-2:2010	Momentary drop in supply voltage
ISO 16750-2:2010	Reset behaviour at voltage drop
ISO 16750-2:2010	Starting profile
ISO 16750-2:2010	Open circuit tests
ISO 16750-2:2010	Reversed voltage
ISO 16750-2:2010	One contact interruption
ISO 16750-2:2010	Multiple contact interruption
ISO 16750-2:2010	short-circuit protection
DIN EN 60664-3	High voltage test
DIN EN 60664-3	Partial discharge test
DIN EN 60664-3	Surge
DIN EN 60664-3	insulation resistance test
ISO 7637-2:2004	transient voltage emissions
ISO 7637-2:2004	Impulse 1
ISO 7637-2:2004	Impulse 2a / 2b
ISO 7637-2:2004	Impulse 3a / 3b
ISO 7637-2:2004	Impulse 4
ISO 7637-2:2004	Impulse 5a / 5b
ISO 10605:2008	contact discharge (direct)
ISO 10605:2008	air discharge (direct)
ISO 10605:2008	contact discharge (indirect)
ISO 10605:2008	"handling and packaging" (contact discharge) (indirect)
ISO 10605:2008	"handling and packaging" (air discharge) (indirect)
ISO 11452-2	interference at 80MHz – 2 GHz
EN 55025	interference field strength in range 150kHz – 2.5 GHz
EN 55025	Interference voltage on vehicle power supply (150kHz-108Mhz)
EN 55025	Interference current on signal and control lines (150kHz-108Mhz)

Standard	Test Name	Test Code	Conditions
VW 80000:2013-06	High Temperature Endurance	L-02	1248h at + 105°C
ISO 20653:2013-02	IP- Code	IP-40	Acc. Standard
VW 80000:2013-06	Humid Heat	K-14	1104h at + 65°C/ 93%RH
EN 60068-2-2:2008	Storage		1700h at 125°C
EN 60664-3:2010	Insulation Coordination		
VW 80000:2013-06	Temperature Shock	K-05	141 Cycles - 40°C/ +125°C,
VW 80000:2013-06	Vibration	M-04	Vibration profile D
VW 80000:2013-06	Temperature Change	L-03	194 Cycles, - 40°C/ +105°C 3 K/min
VW 80000:2013-06	Free Fall	M-01	Fall height 1m in ± x, ± y, ± z direction
	X- Ray		
	Solder Bond Stability		
EN 55025:2008 ISO 7637-2:2011	Emissions		150kHz -2.5Ghz: Cat.1 Severity level 1
ISO 11452-2:2004 ISO 11452-5:2002	Immunity		50V/m: status 1, status 2 100 V/m: status 1
ISO 16750-2:2010 ISO 7637-2:2011	Electrical Disturbances		
ISO 10605:2008	ESD		Up to ± 6kV: status 1

11. Index

Figure 1: CAN-bus	5
Figure 2: Averaging over 5 ms	5
Figure 3: ADC channel 1 and 2	5
Figure 4: Example with two channel on ADC2	6
Figure 5: Example with three channel on ADC2	6
Figure 6: Configuration: 1 current channel, 3 voltage channel, 3 ms measurement interval	7
Figure 7: Configuration: 1 current channel, 2 voltage channel	7
Figure 8: Two channels; 5 ms output rate	8
Figure 9: Four channels; 6 ms output rate	8
Figure 10: Four channels; different measure interval	8
Figure 11: Change measurement range	9
Figure 12: Example for voltage measurement	10
Figure 13: IVT-S 100A, 300A, 500A version	13
Figure 14: IVT-S 1000A and 2500A version	13
Figure 15: Correct mounting 20mm overlap	14
Figure 16: Incorrect mounting 15mm overlap	14
Figure 17: Correct mounting 20mm overlap	14
Figure 18: Incorrect mounting 15mm overlap	14
Figure 19: Pin configuration CANbus and power supply	16
Figure 20: Voltage measurement	16
Figure 21: Ordering code and part description	18
1. Introduction	1
2. Application	1
3. Functionality description	2
3.1. Measurement modes	2
3.2. Output signals	2
3.3. Internal Safety	3
3.4. Log data	3
3.5. Firmware update	4
3.6. Galvanic isolation	4
3.7. Flammability	4
3.8. Communication interface	4
4. Measurement description	5
4.1. Sampling rates	5
4.2. Overcurrent measurement	9
4.3. Temperature calibration	9
4.4. Ranges	9
4.5. Plausibility check (functional safety)	10
4.6. Voltage measurement	10
5. Technical Data	11
5.1. Operation conditions	11
5.2. Maximum ratings	11
5.3. Current measurement	11
5.4. Voltage measurement	12
5.5. Communication	12
6. Mechanical data	13
6.1. Busbar connection	14
6.2. Pin configuration / Power Supply and CANbus	16
6.3. Pin configuration / Voltage measurement	16
6.4. Module Connector	17
6.5. Mating plug	17
7. Part description / Ordering	18
8. CANbus protocol	19
8.1. Default parameters	20
8.2. Result messages	21
8.3. Set CAN ID	23

Datasheet, Version 1.03

8.4.	Config Result.....	23
8.5.	Set-Commands.....	24
8.6.	Get Error- and Logdata.....	27
9.	Startup	41
10.	Qualification	42
11.	Index	44