

# CSD19501KCS 80V N-Channel NexFET™ Power MOSFET

## 1 Features

- Ultra-low  $Q_g$  and  $Q_{gd}$
- Low thermal resistance
- Avalanche rated
- Pb free terminal plating
- RoHS compliant
- Halogen free
- TO-220 plastic package

## 2 Applications

- Secondary side synchronous rectifier
- Motor control

## 3 Description

This 80V, 5.5m $\Omega$ , TO-220 NexFET™ power MOSFET is designed to minimize losses in power conversion applications.

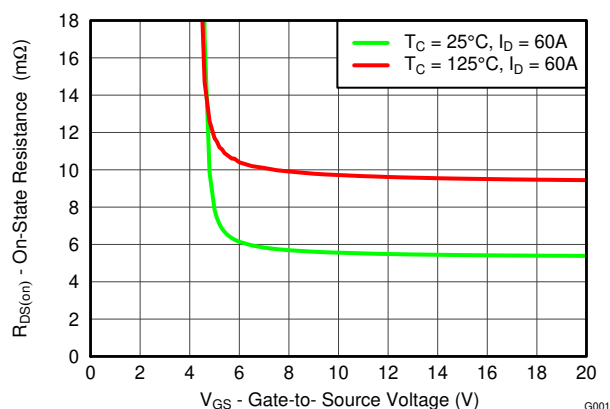
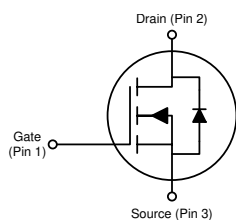

**$R_{DS(on)}$  vs  $V_{GS}$**

## Product Summary

$T_A = 25^\circ\text{C}$		TYPICAL VALUE		UNIT
$V_{DS}$	Drain-to-Source Voltage	80		V
$Q_g$	Gate Charge Total (10V)	38		nC
$Q_{gd}$	Gate Charge Gate-to-Drain	5.8		nC
$R_{DS(on)}$	Drain-to-Source On-Resistance	$V_{GS} = 6\text{V}$	6.2	m $\Omega$
		$V_{GS} = 10\text{V}$	5.5	m $\Omega$
$V_{GS(th)}$	Threshold Voltage	2.6		V

## Ordering Information<sup>(1)</sup>

Device	Package	Media	Qty	Ship
CSD19501KCS	TO-220 Plastic Package	Tube	50	Tube

- (1) For all available packages, see the orderable addendum at the end of the data sheet.

## Absolute Maximum Ratings

$T_A = 25^\circ\text{C}$		VALUE	UNIT
$V_{DS}$	Drain-to-Source Voltage	80	V
$V_{GS}$	Gate-to-Source Voltage	$\pm 20$	V
$I_D$	Continuous Drain Current (Package limited)	100	A
	Continuous Drain Current (Silicon limited), $T_C = 25^\circ\text{C}$	129	
	Continuous Drain Current (Silicon limited), $T_C = 100^\circ\text{C}$	91	
$I_{DM}$	Pulsed Drain Current <sup>(1)</sup>	305	A
$P_D$	Power Dissipation	217	W
$T_J, T_{stg}$	Operating Junction and Storage Temperature Range	-55 to 175	$^\circ\text{C}$
$E_{AS}$	Avalanche Energy, single pulse $I_D = 65\text{A}, L = 0.1\text{mH}, R_G = 25\Omega$	211	mJ

- (1) Max  $R_{\theta JC} = 0.7$ , pulse duration  $\leq 100\mu\text{s}$ , Duty cycle  $\leq 1\%$

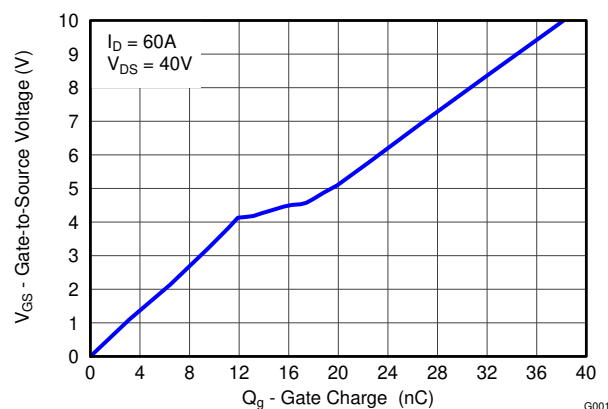

**Gate Charge**



## Table of Contents

<b>1 Features</b> .....	1	5.2 Documentation Support.....	7
<b>2 Applications</b> .....	1	5.3 Receiving Notification of Documentation Updates.....	7
<b>3 Description</b> .....	1	5.4 Support Resources.....	7
<b>4 Specifications</b> .....	3	5.5 Trademarks.....	7
4.1 Electrical Characteristics.....	3	5.6 Electrostatic Discharge Caution.....	7
4.2 Thermal Information.....	3	5.7 Glossary.....	7
4.3 Typical MOSFET Characteristics.....	4	<b>6 Revision History</b> .....	7
<b>5 Device and Documentation Support</b> .....	7	<b>7 Mechanical Data</b> .....	8
5.1 Third-Party Products Disclaimer.....	7		

## 4 Specifications

### 4.1 Electrical Characteristics

(T<sub>A</sub> = 25°C unless otherwise stated)

PARAMETER		TEST CONDITIONS	MIN	TYP	MAX	UNIT
<b>STATIC CHARACTERISTICS</b>						
B <sub>V</sub> DSS	Drain-to-Source Voltage	V <sub>GS</sub> = 0V, I <sub>D</sub> = 250μA	80			V
I <sub>DSS</sub>	Drain-to-Source Leakage Current	V <sub>GS</sub> = 0V, V <sub>DS</sub> = 64V			1	μA
I <sub>GSS</sub>	Gate-to-Source Leakage Current	V <sub>DS</sub> = 0V, V <sub>GS</sub> = 20V			100	nA
V <sub>GS(th)</sub>	Gate-to-Source Threshold Voltage	V <sub>DS</sub> = V <sub>GS</sub> , I <sub>D</sub> = 250μA	2.2	2.6	3.2	V
R <sub>DS(on)</sub>	Drain-to-Source On-Resistance	V <sub>GS</sub> = 6V, I <sub>D</sub> = 60A		6.2	7.9	mΩ
		V <sub>GS</sub> = 10V, I <sub>D</sub> = 60A		5.5	6.6	mΩ
g <sub>fs</sub>	Transconductance	V <sub>DS</sub> = 8V, I <sub>D</sub> = 60A		137		S
<b>DYNAMIC CHARACTERISTICS</b>						
C <sub>iss</sub>	Input Capacitance	V <sub>GS</sub> = 0V, V <sub>DS</sub> = 40V, f = 1 MHz		3060	3980	pF
C <sub>oss</sub>	Output Capacitance			784	1020	pF
C <sub>rss</sub>	Reverse Transfer Capacitance			12.4	16.1	pF
R <sub>G</sub>	Series Gate Resistance			1.3	2.6	Ω
Q <sub>g</sub>	Gate Charge Total (10V)	V <sub>DS</sub> = 40V, I <sub>D</sub> = 60A		38	50	nC
Q <sub>gd</sub>	Gate Charge Gate-to-Drain			5.8		nC
Q <sub>gs</sub>	Gate Charge Gate-to-Source			12.4		nC
Q <sub>g(th)</sub>	Gate Charge at V <sub>th</sub>			7.5		nC
Q <sub>oss</sub>	Output Charge	V <sub>DS</sub> = 40V, V <sub>GS</sub> = 0V		98		nC
t <sub>d(on)</sub>	Turn On Delay Time	V <sub>DS</sub> = 50V, V <sub>GS</sub> = 10V, I <sub>DS</sub> = 60A, R <sub>G</sub> = 0Ω		21		ns
t <sub>r</sub>	Rise Time			15		ns
t <sub>d(off)</sub>	Turn Off Delay Time			39		ns
t <sub>f</sub>	Fall Time			5		ns
<b>DIODE CHARACTERISTICS</b>						
V <sub>SD</sub>	Diode Forward Voltage	I <sub>SD</sub> = 60A, V <sub>GS</sub> = 0V		0.9	1.1	V
Q <sub>rr</sub>	Reverse Recovery Charge	V <sub>DS</sub> = 40V, I <sub>F</sub> = 60A, di/dt = 300A/μs		230		nC
t <sub>rr</sub>	Reverse Recovery Time			74		ns

### 4.2 Thermal Information

(T<sub>A</sub> = 25°C unless otherwise stated)

THERMAL METRIC		MIN	TYP	MAX	UNIT
R <sub>θJC</sub>	Junction-to-Case Thermal Resistance			0.7	°C/W
R <sub>θJA</sub>	Junction-to-Ambient Thermal Resistance			62	

### 4.3 Typical MOSFET Characteristics

( $T_A = 25^\circ\text{C}$  unless otherwise stated)

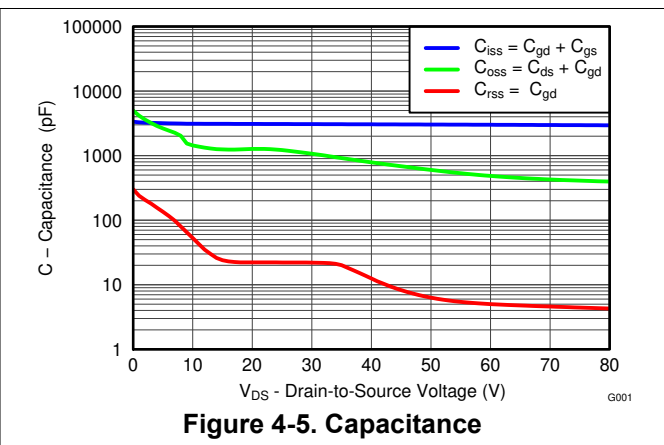
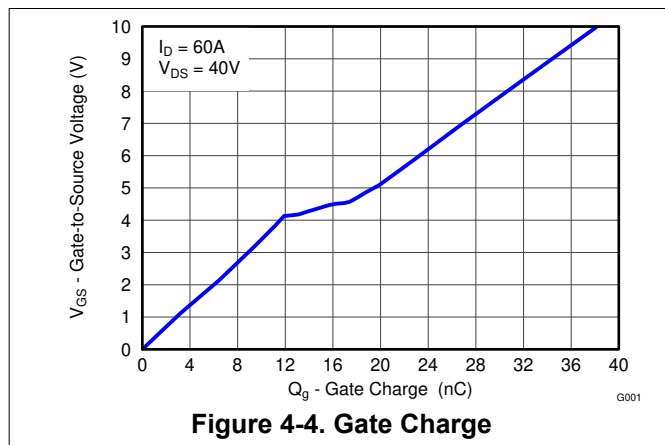
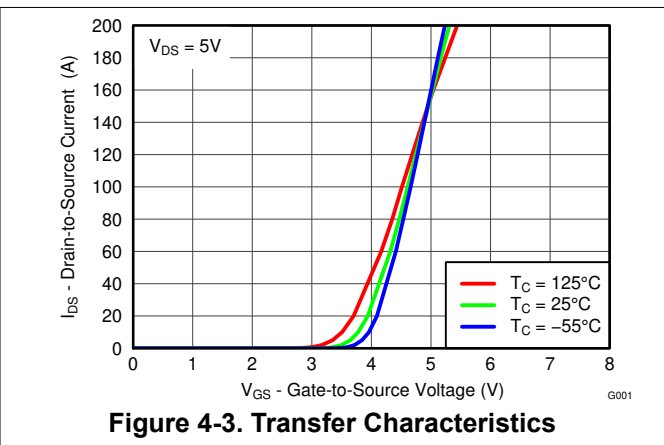
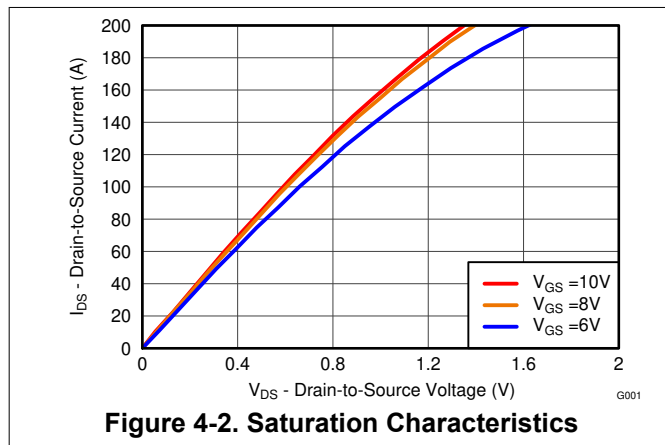
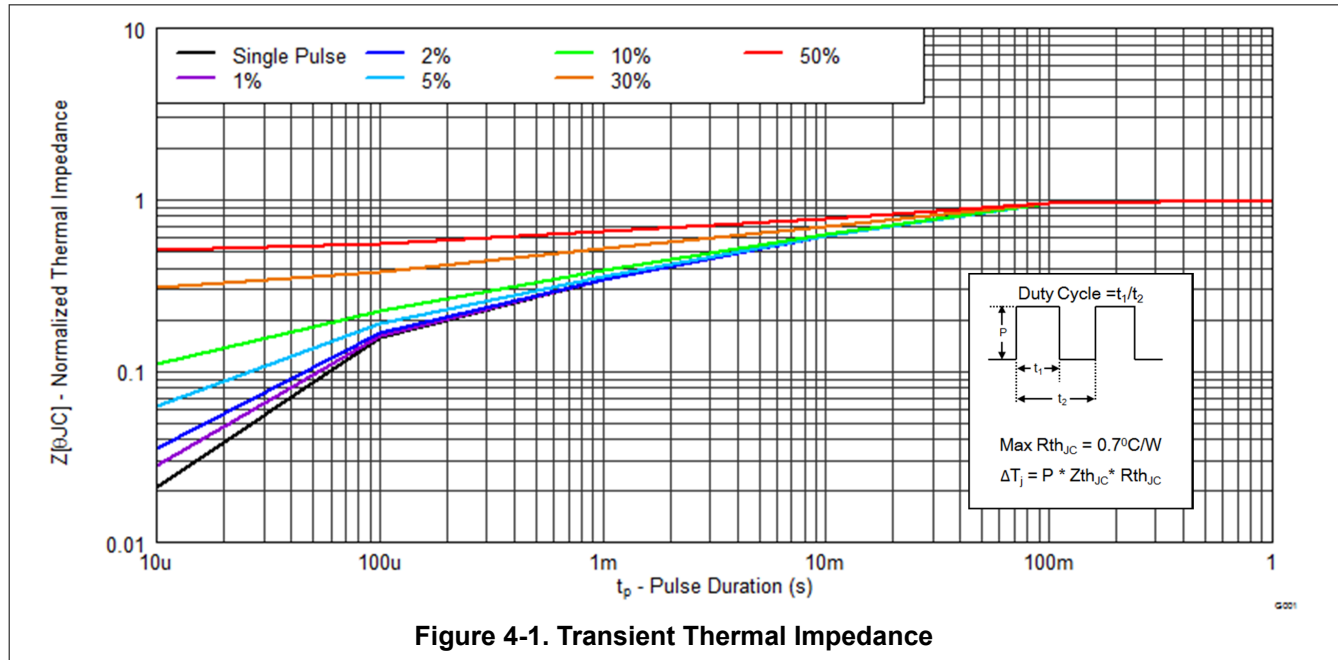

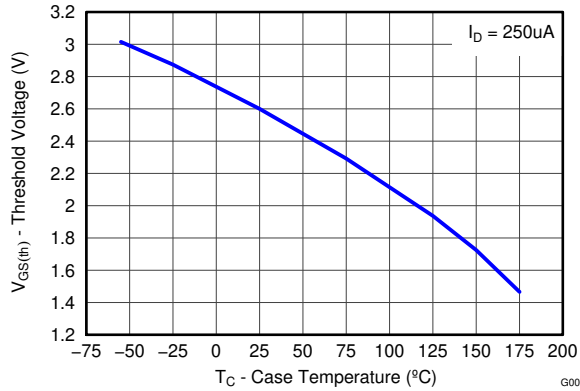

Figure 4-6. Threshold Voltage vs Temperature

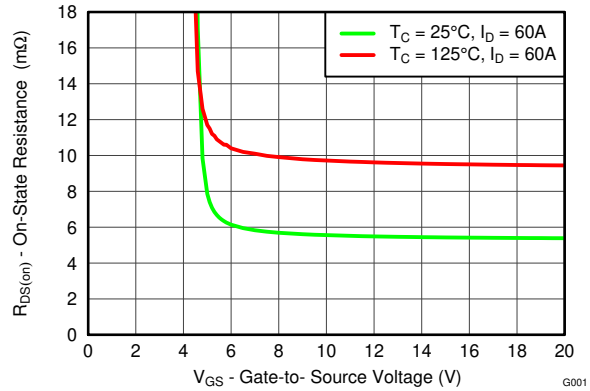

Figure 4-7. On-State Resistance vs Gate-to-Source Voltage

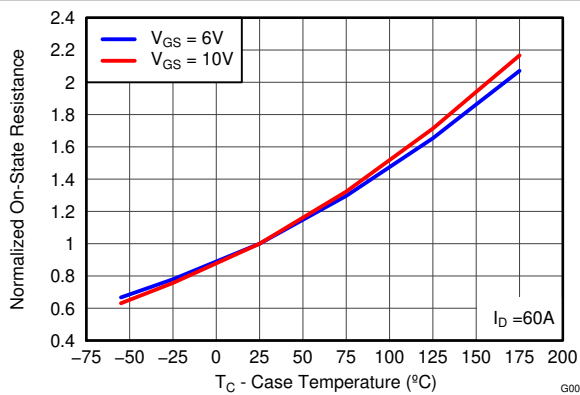

Figure 4-8. Normalized On-State Resistance vs Temperature

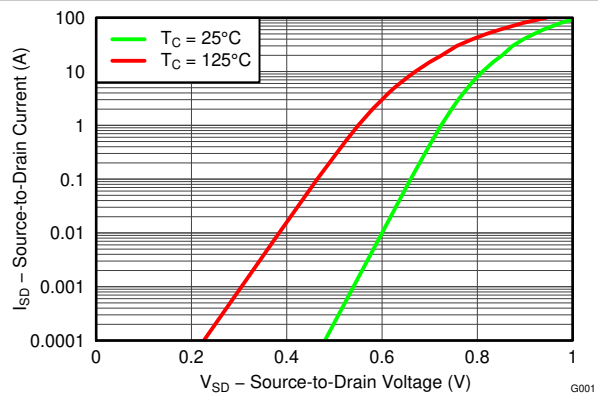

Figure 4-9. Typical Diode Forward Voltage

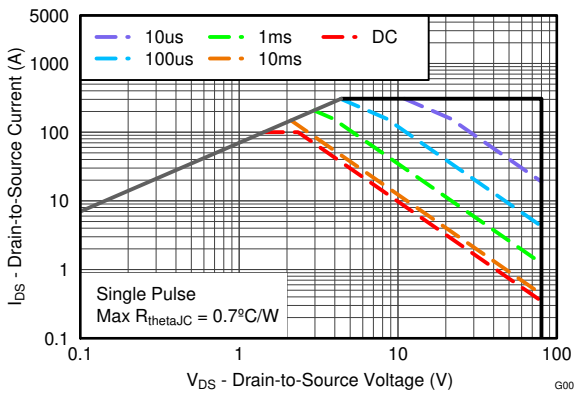

Figure 4-10. Maximum Safe Operating Area

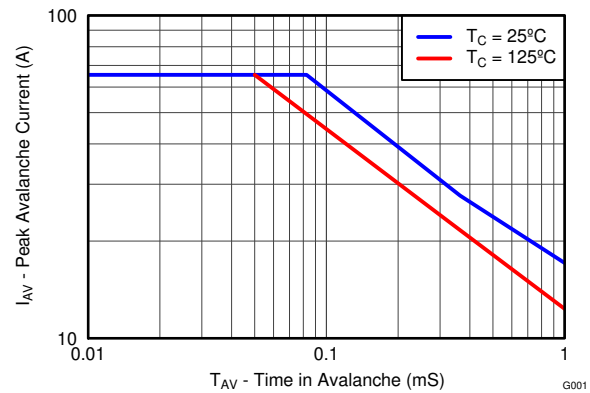
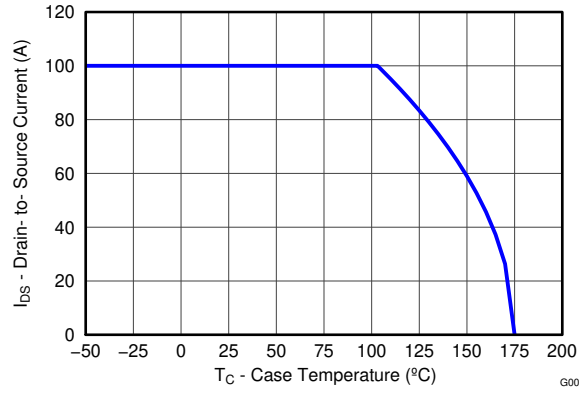

Figure 4-11. Single Pulse Unclamped Inductive Switching



**Figure 4-12. Maximum Drain Current vs Temperature**

## 5 Device and Documentation Support

### 5.1 Third-Party Products Disclaimer

TI'S PUBLICATION OF INFORMATION REGARDING THIRD-PARTY PRODUCTS OR SERVICES DOES NOT CONSTITUTE AN ENDORSEMENT REGARDING THE SUITABILITY OF SUCH PRODUCTS OR SERVICES OR A WARRANTY, REPRESENTATION OR ENDORSEMENT OF SUCH PRODUCTS OR SERVICES, EITHER ALONE OR IN COMBINATION WITH ANY TI PRODUCT OR SERVICE.

### 5.2 Documentation Support

#### 5.2.1 Related Documentation

### 5.3 Receiving Notification of Documentation Updates

To receive notification of documentation updates, navigate to the device product folder on [ti.com](http://ti.com). Click on *Notifications* to register and receive a weekly digest of any product information that has changed. For change details, review the revision history included in any revised document.

### 5.4 Support Resources

[TI E2E™ support forums](#) are an engineer's go-to source for fast, verified answers and design help — straight from the experts. Search existing answers or ask your own question to get the quick design help you need.

Linked content is provided "AS IS" by the respective contributors. They do not constitute TI specifications and do not necessarily reflect TI's views; see TI's [Terms of Use](#).

### 5.5 Trademarks

NexFET™ is a trademark of Texas Instruments.

TI E2E™ is a trademark of Texas Instruments.

All trademarks are the property of their respective owners.

### 5.6 Electrostatic Discharge Caution



This integrated circuit can be damaged by ESD. Texas Instruments recommends that all integrated circuits be handled with appropriate precautions. Failure to observe proper handling and installation procedures can cause damage.

ESD damage can range from subtle performance degradation to complete device failure. Precision integrated circuits may be more susceptible to damage because very small parametric changes could cause the device not to meet its published specifications.

### 5.7 Glossary

[TI Glossary](#) This glossary lists and explains terms, acronyms, and definitions.

## 6 Revision History

<b>Changes from Revision A (August 2014) to Revision B (April 2024)</b>	<b>Page</b>
• Updated the numbering format for tables, figures, and cross-references throughout the document.....	1

<b>Changes from Revision * (January 2014) to Revision A (August 2014)</b>	<b>Page</b>
• I <sub>DM</sub> increased from 146 to 305 .....	1
• Updated pulse current conditions. ....	1
• Updated SOA in <a href="#">Figure 4-10</a> .....	4

## 7 Mechanical Data

The following pages include mechanical, packaging, and orderable information. This information is the most current data available for the designated devices. This data is subject to change without notice and revision of this document. For browser-based versions of this data sheet, refer to the left-hand navigation.



**PACKAGING INFORMATION**

Orderable Device	Status (1)	Package Type	Package Drawing	Pins	Package Qty	Eco Plan (2)	Lead finish/ Ball material (6)	MSL Peak Temp (3)	Op Temp (°C)	Device Marking (4/5)	Samples
CSD19501KCS	ACTIVE	TO-220	KCS	3	50	RoHS-Exempt & Green	SN	N / A for Pkg Type	-55 to 175	CSD19501KCS	<a href="#">Samples</a>

(1) The marketing status values are defined as follows:

**ACTIVE:** Product device recommended for new designs.

**LIFEBUY:** TI has announced that the device will be discontinued, and a lifetime-buy period is in effect.

**NRND:** Not recommended for new designs. Device is in production to support existing customers, but TI does not recommend using this part in a new design.

**PREVIEW:** Device has been announced but is not in production. Samples may or may not be available.

**OBSOLETE:** TI has discontinued the production of the device.

(2) **RoHS:** TI defines "RoHS" to mean semiconductor products that are compliant with the current EU RoHS requirements for all 10 RoHS substances, including the requirement that RoHS substance do not exceed 0.1% by weight in homogeneous materials. Where designed to be soldered at high temperatures, "RoHS" products are suitable for use in specified lead-free processes. TI may reference these types of products as "Pb-Free".

**RoHS Exempt:** TI defines "RoHS Exempt" to mean products that contain lead but are compliant with EU RoHS pursuant to a specific EU RoHS exemption.

**Green:** TI defines "Green" to mean the content of Chlorine (Cl) and Bromine (Br) based flame retardants meet JS709B low halogen requirements of <=1000ppm threshold. Antimony trioxide based flame retardants must also meet the <=1000ppm threshold requirement.

(3) MSL, Peak Temp. - The Moisture Sensitivity Level rating according to the JEDEC industry standard classifications, and peak solder temperature.

(4) There may be additional marking, which relates to the logo, the lot trace code information, or the environmental category on the device.

(5) Multiple Device Markings will be inside parentheses. Only one Device Marking contained in parentheses and separated by a "~" will appear on a device. If a line is indented then it is a continuation of the previous line and the two combined represent the entire Device Marking for that device.

(6) Lead finish/Ball material - Orderable Devices may have multiple material finish options. Finish options are separated by a vertical ruled line. Lead finish/Ball material values may wrap to two lines if the finish value exceeds the maximum column width.

**Important Information and Disclaimer:**The information provided on this page represents TI's knowledge and belief as of the date that it is provided. TI bases its knowledge and belief on information provided by third parties, and makes no representation or warranty as to the accuracy of such information. Efforts are underway to better integrate information from third parties. TI has taken and continues to take reasonable steps to provide representative and accurate information but may not have conducted destructive testing or chemical analysis on incoming materials and chemicals. TI and TI suppliers consider certain information to be proprietary, and thus CAS numbers and other limited information may not be available for release.

In no event shall TI's liability arising out of such information exceed the total purchase price of the TI part(s) at issue in this document sold by TI to Customer on an annual basis.

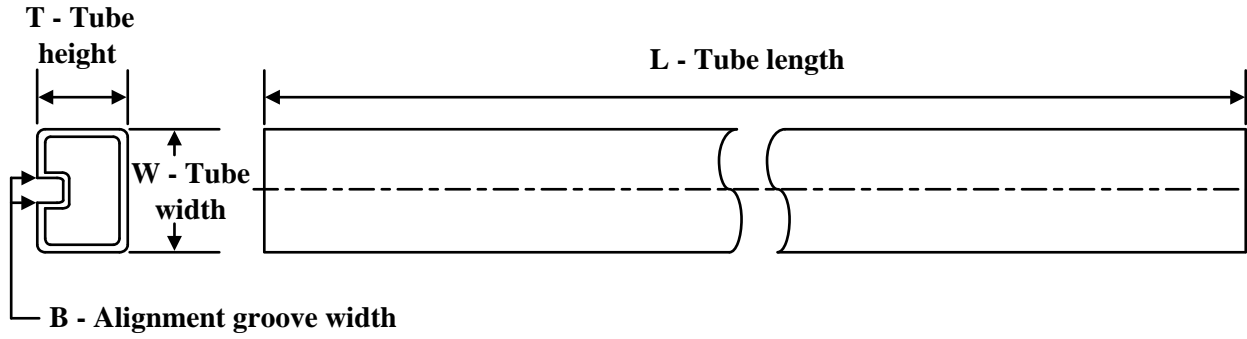
**TUBE**

\*All dimensions are nominal

Device	Package Name	Package Type	Pins	SPQ	L (mm)	W (mm)	T (μm)	B (mm)
CSD19501KCS	KCS	TO-220	3	50	532	34.1	700	9.6
CSD19501KCS	KCS	TO-220	3	50	532	34.1	700	9.6

# KCS0003B

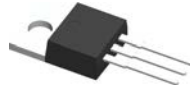

# PACKAGE OUTLINE

TO-220 - 19.65 mm max height

TO-220

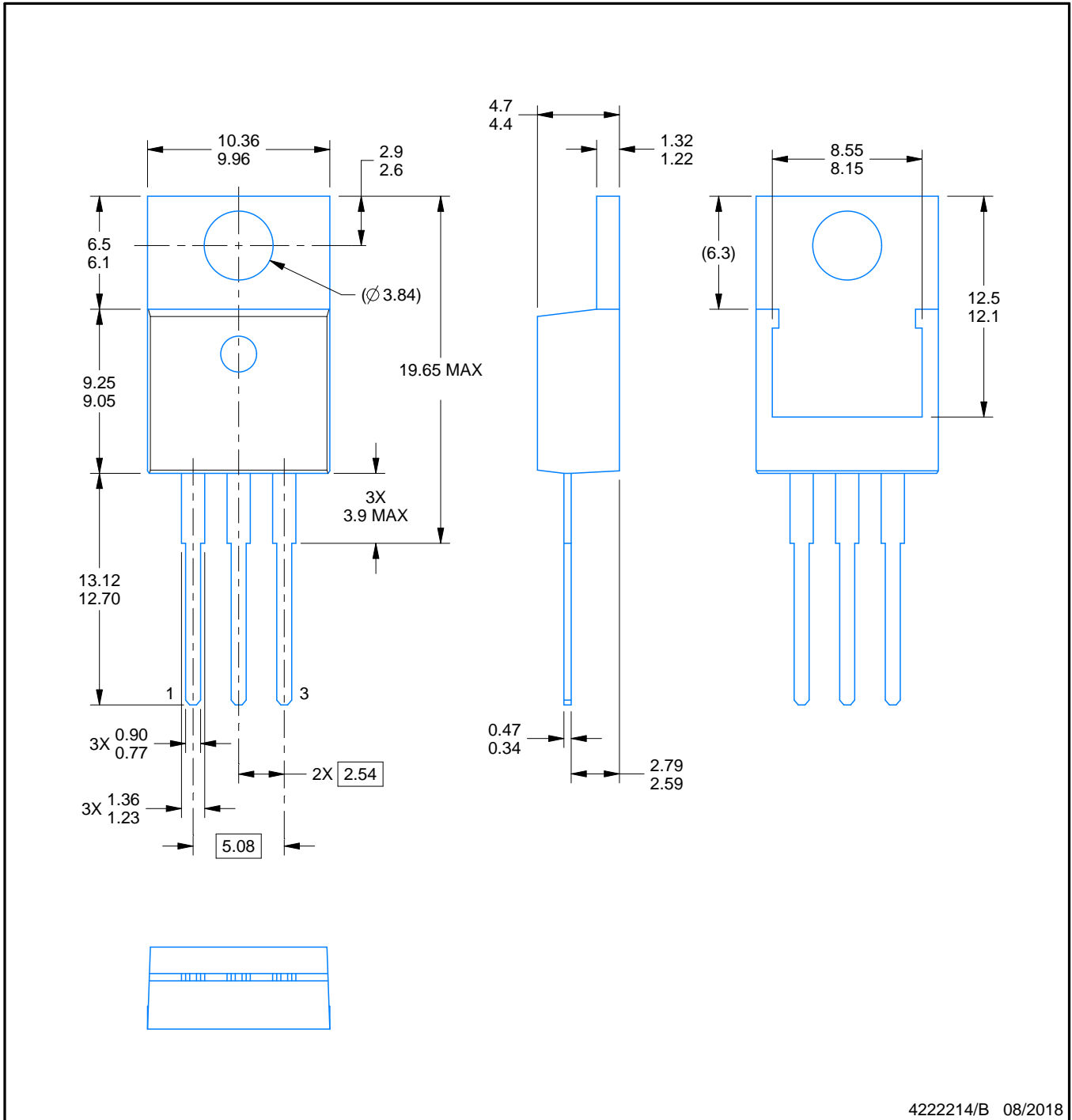

4222214/B 08/2018

### NOTES:

1. Dimensions are in millimeters. Any dimension in brackets or parenthesis are for reference only. Dimensioning and tolerancing per ASME Y14.5M.
2. This drawing is subject to change without notice.
3. Reference JEDEC registration TO-220.

# EXAMPLE BOARD LAYOUT

KCS0003B

TO-220 - 19.65 mm max height

TO-220

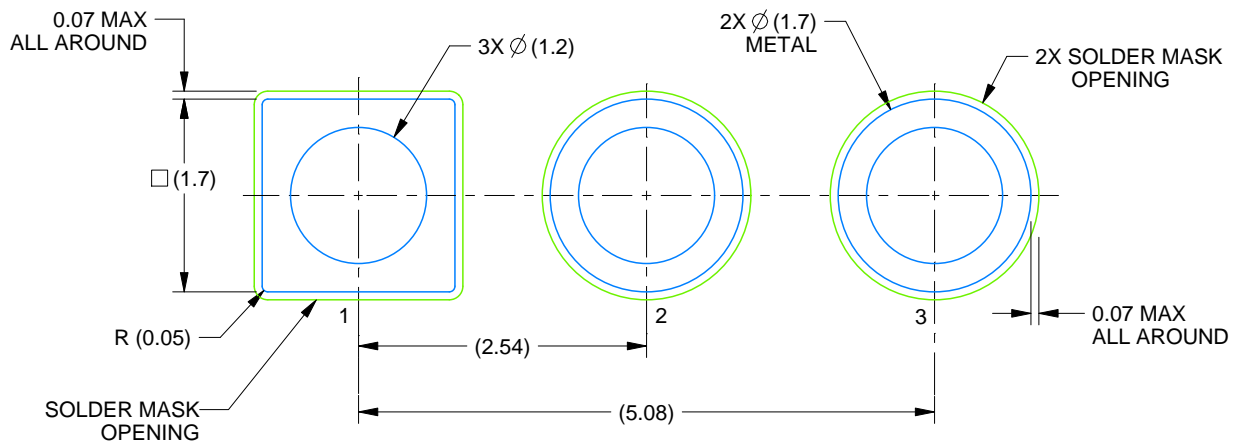

LAND PATTERN EXAMPLE  
NON-SOLDER MASK DEFINED  
SCALE:15X

4222214/B 08/2018

## IMPORTANT NOTICE AND DISCLAIMER

TI PROVIDES TECHNICAL AND RELIABILITY DATA (INCLUDING DATA SHEETS), DESIGN RESOURCES (INCLUDING REFERENCE DESIGNS), APPLICATION OR OTHER DESIGN ADVICE, WEB TOOLS, SAFETY INFORMATION, AND OTHER RESOURCES "AS IS" AND WITH ALL FAULTS, AND DISCLAIMS ALL WARRANTIES, EXPRESS AND IMPLIED, INCLUDING WITHOUT LIMITATION ANY IMPLIED WARRANTIES OF MERCHANTABILITY, FITNESS FOR A PARTICULAR PURPOSE OR NON-INFRINGEMENT OF THIRD PARTY INTELLECTUAL PROPERTY RIGHTS.

These resources are intended for skilled developers designing with TI products. You are solely responsible for (1) selecting the appropriate TI products for your application, (2) designing, validating and testing your application, and (3) ensuring your application meets applicable standards, and any other safety, security, regulatory or other requirements.

These resources are subject to change without notice. TI grants you permission to use these resources only for development of an application that uses the TI products described in the resource. Other reproduction and display of these resources is prohibited. No license is granted to any other TI intellectual property right or to any third party intellectual property right. TI disclaims responsibility for, and you will fully indemnify TI and its representatives against, any claims, damages, costs, losses, and liabilities arising out of your use of these resources.

TI's products are provided subject to [TI's Terms of Sale](#) or other applicable terms available either on [ti.com](https://www.ti.com) or provided in conjunction with such TI products. TI's provision of these resources does not expand or otherwise alter TI's applicable warranties or warranty disclaimers for TI products.

TI objects to and rejects any additional or different terms you may have proposed.

Mailing Address: Texas Instruments, Post Office Box 655303, Dallas, Texas 75265  
Copyright © 2024, Texas Instruments Incorporated