

# Low Voltage Quad 2-Input AND Gate with 3.6 V Tolerant Inputs and Outputs

## 74ALVC08

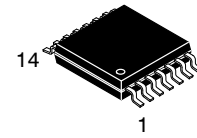

TSSOP-14 WB  
CASE 948G

### General Description

The ALVC08 contains four 2-input AND gates. This product is designed for low voltage (1.65 V to 3.6 V)  $V_{CC}$  applications with I/O compatibility up to 3.6 V.

The ALVC08 is fabricated with an advanced CMOS technology to achieve high-speed operation while maintaining low CMOS power dissipation.

### Features

- 1.65 V to 3.6 V  $V_{CC}$  Supply Operation
- 3.6 V Tolerant Inputs and Outputs
- $t_{PD}$ 
  - ♦ 2.9 ns Max for 3.0 V to 3.6 V  $V_{CC}$
  - ♦ 3.2 ns Max for 2.3 V to 2.7 V  $V_{CC}$
  - ♦ 5.3 ns Max for 1.65 V to 1.95 V  $V_{CC}$
- Power-off High Impedance Inputs and Outputs
- Uses Quiet Series Noise/EMI Reduction Circuitry
- Latchup Conforms to JEDEC JED78
- ESD Performance:
  - ♦ Human Body Model > 2000 V
  - ♦ Machine Model > 250 V
- These Devices are Pb-Free and Halide Free

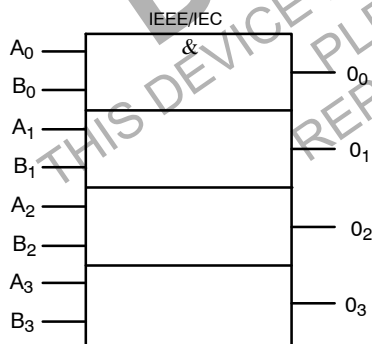
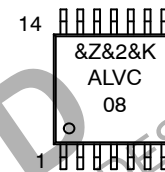

Figure 1. Logic Diagram

### MARKING DIAGRAM



- &Z = Assembly Location
- &2 = 2-Digit Date Code (Year & Week)
- &K = Lot Run Traceability Code
- ALVC08 = Specific Device Code

### CONNECTION DIAGRAM

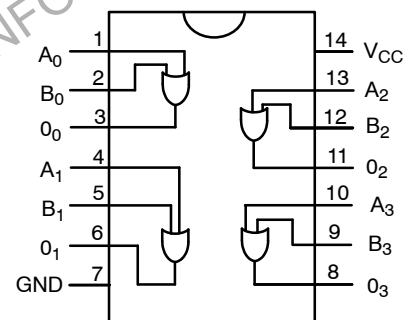

### ORDERING INFORMATION

| Device       | Package            | Shipping†          |
|--------------|--------------------|--------------------|
| 74ALVC08MTCX | TSSOP-14 (Pb-Free) | 2500 / Tape & Reel |

†For information on tape and reel specifications, including part orientation and tape sizes, please refer to our Tape and Reel Packaging Specifications Brochure, [BRD8011/D](#).

### PIN DESCRIPTION

| Pin        | Description |
|------------|-------------|
| $A_n, B_n$ | Inputs      |
| $O_n$      | Outputs     |

**ABSOLUTE MAXIMUM RATINGS**

| Symbol                   | Parameter                                       | Value                  | Unit         |
|--------------------------|---|------------------------|--------------|
| $V_{CC}$                 | Supply Voltage                                  | -0.5 to + 4.6          | V            |
| $V_I$                    | DC Input Voltage                                | -0.5 to + 4.6          | V            |
| $V_O$                    | Output Voltage (Note 1)                         | -0.5 to $V_{CC} + 0.5$ | V            |
| $I_{IK}$                 | DC Input Diode Current<br>$V_I < 0$ V           | -50                    | mA           |
| $I_{OK}$                 | DC Output Diode Current<br>$V_O < 0$ V          | -50                    | mA           |
| $I_{OH}/I_{OL}$          | DC Output Source / Sink Current                 | $\pm 50$               | mA           |
| $I_{CC}$ or<br>$I_{GND}$ | DC $V_{CC}$ or Ground Current<br>per Output Pin | $\pm 100$              | mA           |
| $T_{STG}$                | Storage Temperature                             | -65 to +150            | $^{\circ}$ C |

Stresses exceeding those listed in the Maximum Ratings table may damage the device. If any of these limits are exceeded, device functionality should not be assumed, damage may occur and reliability may be affected.

**RECOMMENDED OPERATING CONDITIONS** (Note 2)

| Symbol                | Parameter   | Min  | Max      | Unit         |
|-----------------------|---|------|----------|--------------|
| $V_{CC}$              | Supply Voltage  | 1.65 | 3.6      | V            |
| $V_I$                 | Input Voltage   | 0    | $V_{CC}$ | V            |
| $V_O$                 | Output Voltage  | 0    | $V_{CC}$ | V            |
| $T_A$                 | Free Air Operating Temperature                                  | -40  | +85      | $^{\circ}$ C |
| $\Delta t / \Delta V$ | Input Edge Rate,<br>$V_{IN} = 0.8$ V to 2.0 V, $V_{CC} = 3.0$ V | 0    | 5        | ns/V         |

Functional operation above the stresses listed in the Recommended Operating Ranges is not implied. Extended exposure to stresses beyond the Recommended Operating Ranges limits may affect device reliability.

1.  $I_O$  Absolute Maximum Rating must be observed, limited to 4.6 V.
2. Floating or unused control inputs must be held HIGH or LOW.

# 74ALVC08

## DC ELECTRICAL CHARACTERISTICS

| Symbol                   | Parameter                             | Conditions  | V <sub>CC</sub> (V) | Min                    | Max                    | Unit |
|--------------------------|---------------------------------------|---|---------------------|------------------------|------------------------|------|
| V <sub>IH</sub>          | HIGH Level Input Voltage              |   | 1.65 – 1.95         | 0.65 × V <sub>CC</sub> | –                      | V    |
|                          |                                       |   | 2.3 – 2.7           | 1.7                    | –                      |      |
|                          |                                       |   | 2.7 – 3.6           | 2.0                    | –                      |      |
| V <sub>IL</sub>          | LOW Level Input Voltage               |   | 1.65 – 1.95         | –                      | 0.35 × V <sub>CC</sub> | V    |
|                          |                                       |   | 2.3 – 2.7           | –                      | 0.7                    |      |
|                          |                                       |   | 2.7 – 3.6           | –                      | 0.8                    |      |
| V <sub>OH</sub>          | HIGH Level Output Voltage             | I <sub>OH</sub> = –100 μA                                   | 1.65 – 3.6          | V <sub>CC</sub> – 0.2  | –                      | V    |
|                          |                                       | I <sub>OH</sub> = –4 mA                                     | 1.65                | 1.2                    | –                      |      |
|                          |                                       | I <sub>OH</sub> = –6 mA                                     | 2.3                 | 2.0                    | –                      |      |
|                          |                                       | I <sub>OH</sub> = –12 mA                                    | 2.3                 | 1.7                    | –                      |      |
|                          |                                       |   | 2.7<br>3.0          | 2.2<br>2.4             | –                      |      |
| I <sub>OH</sub> = –24 mA | 3.0                                   | 2   | –                   |                        |                        |      |
| V <sub>OL</sub>          | LOW Level Output Voltage              | I <sub>OL</sub> = 100 μA                                    | 1.65 – 3.6          | –                      | 0.2                    | V    |
|                          |                                       | I <sub>OL</sub> = 4 mA                                      | 1.65                | –                      | 0.45                   |      |
|                          |                                       | I <sub>OL</sub> = 6 mA                                      | 2.3                 | –                      | 0.4                    |      |
|                          |                                       | I <sub>OL</sub> = 12 mA                                     | 2.3                 | 0.7                    | –                      |      |
|                          |                                       |   | 2.7                 | 0.4                    | –                      |      |
| I <sub>OL</sub> = 24 mA  | 3.0                                   | –   | 0.55                |                        |                        |      |
| I <sub>I</sub>           | Input Leakage Current                 | 0 ≤ V <sub>I</sub> ≤ 3.6 V                                  | 3.6                 | –                      | ±5.0                   | μA   |
| I <sub>CC</sub>          | Quiescent Supply Current              | V <sub>I</sub> = V <sub>CC</sub> or GND, I <sub>O</sub> = 0 | 3.6                 | –                      | 40                     | μA   |
| ΔI <sub>CC</sub>         | Increase in I <sub>CC</sub> per Input | V <sub>IH</sub> = V <sub>CC</sub> – 0.6 V                   | 3 – 3.6             | –                      | 750                    | μA   |

## AC ELECTRICAL CHARACTERISTICS

| Symbol                              | Parameter         | T <sub>A</sub> = –40°C to +85°C, R <sub>L</sub> = 500 Ω |      |                         |      |                                 |      |                                  |      | Unit |
|-------------------------------------|-------------------|---|------|-------------------------|------|---------------------------------|------|----------------------------------|------|------|
|                                     |                   | C <sub>L</sub> = 50 pF                                  |      |                         |      | C <sub>L</sub> = 30 pF          |      |                                  |      |      |
|                                     |                   | V <sub>CC</sub> = 3.3 V ± 0.3 V                         |      | V <sub>CC</sub> = 2.7 V |      | V <sub>CC</sub> = 2.5 V ± 0.2 V |      | V <sub>CC</sub> = 1.8 V ± 0.15 V |      |      |
|                                     |                   | Min.  | Max. | Min.                    | Max. | Min.                            | Max. | Min.                             | Max. |      |
| t <sub>PHL</sub> , t <sub>PLH</sub> | Propagation Delay | 1.2   | 2.9  | –                       | 3.0  | 1.0                             | 3.2  | 1.2                              | 5.3  | ns   |

## CAPACITANCE

| Symbol          | Parameter                     | Conditions                              | T <sub>A</sub> = +25°C |     | Unit |
|-----------------|-------------------------------|---|------------------------|-----|------|
|                 |                               |   | V <sub>CC</sub>        | Typ |      |
| C <sub>IN</sub> | Input Capacitance             | V <sub>I</sub> = 0 V or V <sub>CC</sub> | 3.3                    | 4.5 | pF   |
| C <sub>PD</sub> | Power Dissipation Capacitance | f = 10 MHz, C <sub>L</sub> = 50 pF      | 3.3                    | 26  | pF   |
|                 |                               |   | 2.5                    | 25  |      |
|                 |                               |   | 1.8                    | 24  |      |

# 74ALVC08

## AC LOADING AND WAVEFORMS

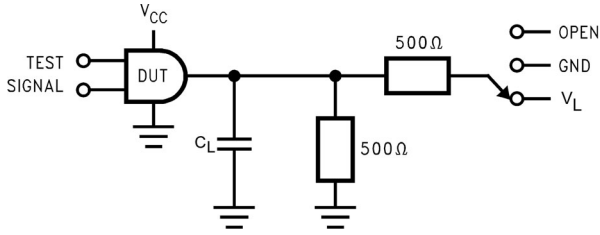

Figure 2. AC Test Circuit

Table 1. VALUES FOR FIGURE 2

| Test                  | Switch |
|-----------------------|--------|
| $t_{PLH}$ , $t_{PHL}$ | Open   |

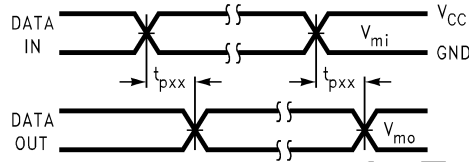
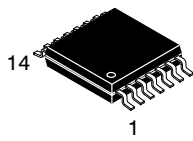

Figure 3. Waveform for Inverting and Non-Inverting Functions

Table 2. VARIABLE MATRIX (Input Characteristics;  $f = 1 \text{ MHz}$ ,  $t_r = t_f = 2 \text{ ns}$ ,  $Z_0 = 5 \Omega$ )

| Symbol   | $V_{CC}$                          |                 |                                   |                                    |
|----------|-----------------------------------|-----------------|-----------------------------------|------------------------------------|
|          | $3.3 \text{ V} \pm 0.3 \text{ V}$ | $2.7 \text{ V}$ | $2.5 \text{ V} \pm 0.2 \text{ V}$ | $1.8 \text{ V} \pm 0.15 \text{ V}$ |
| $V_{mi}$ | $1.5 \text{ V}$                   | $1.5 \text{ V}$ | $V_{CC}/2$                        | $V_{CC}/2$                         |
| $V_{mo}$ | $1.5 \text{ V}$                   | $1.5 \text{ V}$ | $V_{CC}/2$                        | $V_{CC}/2$                         |

# MECHANICAL CASE OUTLINE PACKAGE DIMENSIONS



TSSOP-14 WB  
CASE 948G  
ISSUE C

DATE 17 FEB 2016

SCALE 2:1



NOTES:

- DIMENSIONING AND TOLERANCING PER ANSI Y14.5M, 1982.
- CONTROLLING DIMENSION: MILLIMETER.
- DIMENSION A DOES NOT INCLUDE MOLD FLASH, PROTRUSIONS OR GATE BURRS. MOLD FLASH OR GATE BURRS SHALL NOT EXCEED 0.15 (0.006) PER SIDE.
- DIMENSION B DOES NOT INCLUDE INTERLEAD FLASH OR PROTRUSION. INTERLEAD FLASH OR PROTRUSION SHALL NOT EXCEED 0.25 (0.010) PER SIDE.
- DIMENSION K DOES NOT INCLUDE DAMBAR PROTRUSION. ALLOWABLE DAMBAR PROTRUSION SHALL BE 0.08 (0.003) TOTAL IN EXCESS OF THE K DIMENSION AT MAXIMUM MATERIAL CONDITION.
- TERMINAL NUMBERS ARE SHOWN FOR REFERENCE ONLY.
- DIMENSION A AND B ARE TO BE DETERMINED AT DATUM PLANE -W-.

| DIM | MILLIMETERS |      | INCHES    |       |
|-----|-------------|------|-----------|-------|
|     | MIN         | MAX  | MIN       | MAX   |
| A   | 4.90        | 5.10 | 0.193     | 0.200 |
| B   | 4.30        | 4.50 | 0.169     | 0.177 |
| C   | ---         | 1.20 | ---       | 0.047 |
| D   | 0.05        | 0.15 | 0.002     | 0.006 |
| F   | 0.50        | 0.75 | 0.020     | 0.030 |
| G   | 0.65 BSC    |      | 0.026 BSC |       |
| H   | 0.50        | 0.60 | 0.020     | 0.024 |
| J   | 0.09        | 0.20 | 0.004     | 0.008 |
| J1  | 0.09        | 0.16 | 0.004     | 0.006 |
| K   | 0.19        | 0.30 | 0.007     | 0.012 |
| K1  | 0.19        | 0.25 | 0.007     | 0.010 |
| L   | 6.40 BSC    |      | 0.252 BSC |       |
| M   | 0°          | 8°   | 0°        | 8°    |

GENERIC MARKING DIAGRAM\*



- A = Assembly Location
- L = Wafer Lot
- Y = Year
- W = Work Week
- = Pb-Free Package

(Note: Microdot may be in either location)

\*This information is generic. Please refer to device data sheet for actual part marking. Pb-Free indicator, "G" or microdot "▪", may or may not be present. Some products may not follow the Generic Marking.

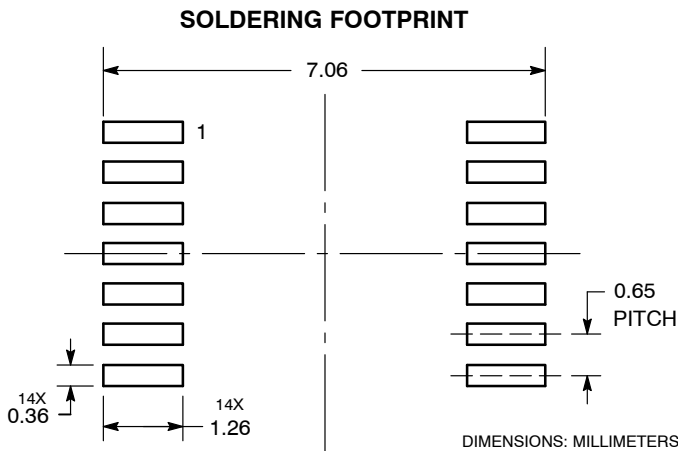

|                  |             |  |
|------------------|-------------|--|
| DOCUMENT NUMBER: | 98ASH70246A | Electronic versions are uncontrolled except when accessed directly from the Document Repository. Printed versions are uncontrolled except when stamped "CONTROLLED COPY" in red. |
| DESCRIPTION:     | TSSOP-14 WB | PAGE 1 OF 1  |

onsemi and onsemi are trademarks of Semiconductor Components Industries, LLC dba onsemi or its subsidiaries in the United States and/or other countries. onsemi reserves the right to make changes without further notice to any products herein. onsemi makes no warranty, representation or guarantee regarding the suitability of its products for any particular purpose, nor does onsemi assume any liability arising out of the application or use of any product or circuit, and specifically disclaims any and all liability, including without limitation special, consequential or incidental damages. onsemi does not convey any license under its patent rights nor the rights of others.

**onsemi**, **Onsemi**, and other names, marks, and brands are registered and/or common law trademarks of Semiconductor Components Industries, LLC dba "**onsemi**" or its affiliates and/or subsidiaries in the United States and/or other countries. **onsemi** owns the rights to a number of patents, trademarks, copyrights, trade secrets, and other intellectual property. A listing of **onsemi**'s product/patent coverage may be accessed at [www.onsemi.com/site/pdf/Patent-Marking.pdf](http://www.onsemi.com/site/pdf/Patent-Marking.pdf). **onsemi** reserves the right to make changes at any time to any products or information herein, without notice. The information herein is provided "as-is" and **onsemi** makes no warranty, representation or guarantee regarding the accuracy of the information, product features, availability, functionality, or suitability of its products for any particular purpose, nor does **onsemi** assume any liability arising out of the application or use of any product or circuit, and specifically disclaims any and all liability, including without limitation special, consequential or incidental damages. Buyer is responsible for its products and applications using **onsemi** products, including compliance with all laws, regulations and safety requirements or standards, regardless of any support or applications information provided by **onsemi**. "Typical" parameters which may be provided in **onsemi** data sheets and/or specifications can and do vary in different applications and actual performance may vary over time. All operating parameters, including "Typicals" must be validated for each customer application by customer's technical experts. **onsemi** does not convey any license under any of its intellectual property rights nor the rights of others. **onsemi** products are not designed, intended, or authorized for use as a critical component in life support systems or any FDA Class 3 medical devices or medical devices with a same or similar classification in a foreign jurisdiction or any devices intended for implantation in the human body. Should Buyer purchase or use **onsemi** products for any such unintended or unauthorized application, Buyer shall indemnify and hold **onsemi** and its officers, employees, subsidiaries, affiliates, and distributors harmless against all claims, costs, damages, and expenses, and reasonable attorney fees arising out of, directly or indirectly, any claim of personal injury or death associated with such unintended or unauthorized use, even if such claim alleges that **onsemi** was negligent regarding the design or manufacture of the part. **onsemi** is an Equal Opportunity/Affirmative Action Employer. This literature is subject to all applicable copyright laws and is not for resale in any manner.

## ADDITIONAL INFORMATION

### TECHNICAL PUBLICATIONS:

Technical Library: [www.onsemi.com/design/resources/technical-documentation](http://www.onsemi.com/design/resources/technical-documentation)  
onsemi Website: [www.onsemi.com](http://www.onsemi.com)

### ONLINE SUPPORT: [www.onsemi.com/support](http://www.onsemi.com/support)

For additional information, please contact your local Sales Representative at [www.onsemi.com/support/sales](http://www.onsemi.com/support/sales)