



7890-7891

## Snipe Nose Pliers with Dual-Component Synthetic Handle





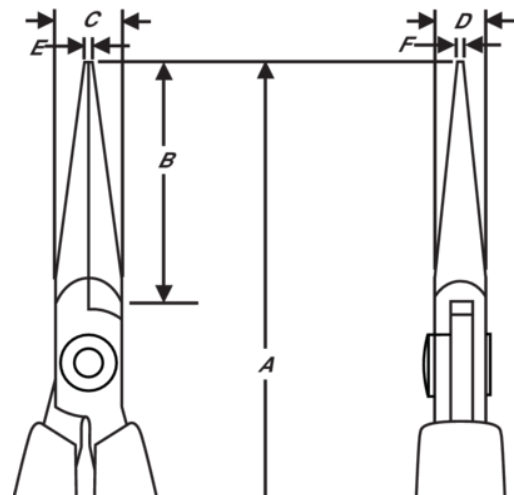

### PRODUCT DETAILS

- Material: High performance alloy steel
- Polished and induction hardened to 58–60 HRC
- Precision screw joint that minimizes friction and maximizes jaw alignment
- ESD safe handles in synthetic material with leaf springs
- Natural finish







PRODUCT ATTRIBUTES

Product: **7890**

	Chain Nose		M	<b>A</b>	132 mm
<b>A</b>	5.20 in	<b>B</b>	32 mm	<b>B</b>	1.26 in
<b>C</b>	9 mm	<b>C</b>	0.35 in	<b>D</b>	6 mm
<b>D</b>	0.24 inch	<b>E</b>	1.2 mm	<b>E</b>	0.05 in
<b>F</b>	0.8 mm	<b>F</b>	0.03 in		Smooth
	72 g	<b>Ω</b>	Dissipative		

Product: **7891**

	Chain Nose		M	<b>A</b>	132 mm
<b>A</b>	5.20 in	<b>B</b>	32 mm	<b>B</b>	1.26 in
<b>C</b>	9 mm	<b>C</b>	0.35 in	<b>D</b>	6 mm
<b>D</b>	0.24 inch	<b>E</b>	1.2 mm	<b>E</b>	0.05 in
<b>F</b>	0.8 mm	<b>F</b>	0.03 in		Serrated
	72 g	<b>Ω</b>	Dissipative		