



7280

Precision 45° Oblique Cutters 0.2 mm-08 mm







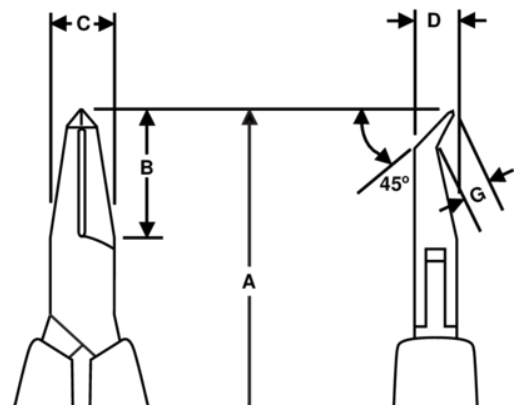

PRODUCT DETAILS

- Material: High performance alloy steel
- Polished and precision induction hardened to 63–65 HRC
- Precision screw joint that minimizes friction and maximizes alignment of cutting edges
- ESD safe handles in synthetic material with leaf springs
- Cutting capacity is listed for solid cooper wire



PRODUCT ATTRIBUTES

Product: **7280**

	Angle 45°		S		Flush
	0.2-08 mm		0.01-0.03 in	A	120 mm
A	4.72 in	B	20 mm	B	0.79 in
C	9 mm	C	0.35 in	D	6 mm
D	0.24 inch	F	3.5 mm	F	0.14 in
	56 g	Ω	Dissipative		