



RX-8149 ERGO™ Precision Diagonal Tip Cutters







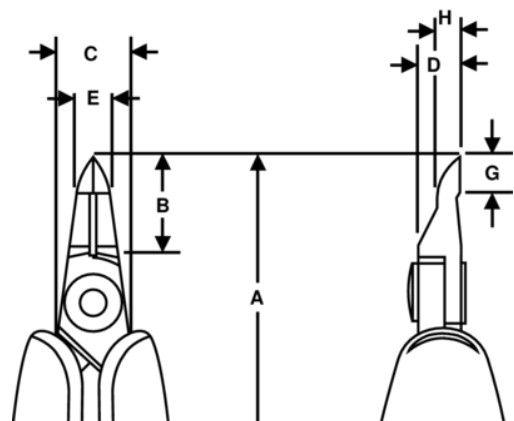

PRODUCT DETAILS

- Ideal for use on multi-lead components and rework
- Two-component Ergo™ handles: thermoplastic surface on tough polypropylene provides
- Material: High performance alloy steel
- Precision induction hardened cutting edges to 63–65 HRC
- ESD safe handles in 2-component synthetic material
- Micro-Touch™: The shape of the handles makes it possible to control and rotate the pliers between thumb and index finger for precision work
- Precision screw joint that minimizes friction and maximizes alignment of cutting edges
- Phosphated finish
- Biospring® reduces tension throughout the working cycle of the tool and can be adjusted in three different positions
- Cutting capacity is listed for solid copper wire



PRODUCT ATTRIBUTES

Product: **RX-8149**

	Tip Cutter		S	A	139.0 mm
A	5.47 in	B	14 mm	B	0.55 in
C	10 mm	C	0.39 in	D	6 mm
D	0.24 inch	E	5 mm	E	0.2 in
G	5 mm	G	0.2 in	H	3.2 mm
H	0.13 in		0.1-0.6 mm		0.01-0.02 in
	Flush		70 g	Ω	Dissipative